



2017

MATEROVCOMPETITION manual

EXPLORER

16th Annual
MATE International ROV Competition
Port Cities of the Future: Commerce, Entertainment, Health, and Safety

MTS marine technology society
ROV SOCIETY
NOAA
NSF
OCEANEERING®
LONG BEACH CITY COLLEGE

June 23-25, 2017 » Long Beach City College » Long Beach, California



This work is licensed under a [Creative Commons Attribution-NonCommercial-NoDerivatives 4.0 International License](https://creativecommons.org/licenses/by-nc-nd/4.0/). Under this license you may download and share this presentation. Please give credit to the MATE Center and MATE II. You may not use these materials for commercial purposes without written permission from the MATE Center and MATE II.

Please click on the Creative Common link above for license details.

www.marinetech.org

2017 MATE ROV COMPETITION:

Port Cities of the Future: Commerce, Entertainment, Health, and Safety

EXPLORER CLASS COMPETITION MANUAL

For general competition information, including a description of the different competition classes, eligibility, and demonstration requirements, visit [Team Info](#).

CONTENTS

OVERVIEW	2
THINK OF YOURSELVES AS ENTREPRENEURS	2
PART 1: PRODUCT DEMONSTRATION	3
OVERVIEW	3
SCORING OVERVIEW	4
TIME	4
EXPLORER CLASS DEMONSTRATION – NOTE CHANGES IN 2017!!!	5
NEED	8
REQUEST FOR PROPOSALS (RFP)	8
SIZE AND WEIGHT RESTRICTIONS	15
PRODUCT DEMONSTRATION	17
TASK 1: COMMERCE: HYPERLOOP CONSTRUCTION	17
TASK 2: ENTERTAINMENT: LIGHT AND WATER SHOW MAINTENANCE	19
TASK 3: HEALTH: ENVIRONMENTAL CLEANUP	22
TASK 4: SAFETY: RISK MITIGATION	25
PRODUCT DEMONSTRATION RESOURCES	31
PART 2: PRODUCT DEMONSTRATION PROP BUILDING INSTRUCTIONS & PHOTOS	31
PART 3: VEHICLE DESIGN & BUILDING SPECIFICATIONS	32
1.0 GENERAL	32
1.1 Glossary and Acronyms	32
1.2 Conventions	32

1.3 Documentation Required	32
2.0 SAFETY.....	34
2.1 Job Site Safety Analysis	34
2.2 Safety Pre-inspection	36
2.3 Safety Inspection	38
2.4 Safety inspection protocol.....	38
2.5 Safety Inspection Points.....	38
3.0 SPECIFICATIONS	39
3.1 Operational	39
3.2 Mechanical/Physical	40
3.3 Electrical	41
3.4 Onboard Electrical Power.....	45
3.5 Power Shutdown.....	45
3.6 Fluid Power	45
3.7 Control Systems.....	48
3.8 Command, Control, & Communications (C3).....	49
3.9 MATE Provided Equipment	49
3.10 Laser Safety Rules.....	50
PART 4: COMPETITION RULES.....	51
GENERAL.....	51
PROCEDURAL	52
DESIGN & SAFETY CONSIDERATIONS	55
PART 5: ENGINEERING & COMMUNICATION.....	56
TIPS FOR EFFECTIVE WRITTEN AND ORAL COMMUNICATION	56
COMPANY SPEC SHEET (ONE PAGE ONLY).....	58
TECHNICAL DOCUMENTATION.....	59
PRODUCT PRESENTATION.....	62
MARKETING DISPLAY.....	66
<i>NEW IN 2017!</i> OUTREACH AND INSPIRATION	69

OVERVIEW

THINK OF YOURSELVES AS ENTREPRENEURS

From deepwater oil drilling to the exploration of shipwrecks and installation of instruments on the seafloor,

individuals who possess entrepreneurial skills are in high demand and stand out in the crowd of potential job candidates. What are entrepreneurial skills? They include the ability to understand the breadth of business operations (e.g., finances, research and development, media outreach), work as an integral part of a company, think critically, and apply technical knowledge and skills in new and innovative ways.

To help you to better understand and develop these skills, the MATE ROV competition challenges you to think of yourself as an entrepreneur. Your first task is to create a company or organization that specializes in solutions to real-world marine technology problems. Use the following questions as a guide.

- What is your company name?
- Who are its leaders – the CEO (chief executive officer – the leader) and CFO (chief financial officer who oversees the budget and spending)?
- Who manages Government and Regulatory Affairs (i.e. who’s in charge of reviewing the competition rules and making sure that they are understood and followed by everyone)?
- Who is responsible for research and development (R&D)?
- Who is responsible for system(s) engineering? Design integration? Testing? Operations?
- Who is responsible for fund-raising, marketing, and media outreach?
- What other positions might you need? (Depending on your personnel resources, more than one person may fill more than one role.)
- What products and services do you provide?
- Who are your potential clients?

In this case, the MATE Center and the Port of Long Beach are your “clients” who recently released a request for proposals. A request for proposals (RFP) is a document that an organization posts to solicit bids from potential companies for a product or service. The specifics of your product design and rules of operation as well as the specifics of your product demonstration are included below.

PART 1: PRODUCT DEMONSTRATION

OVERVIEW

EXPLORER class companies will take part in ONE product demonstration that consists of four distinct tasks. Companies will get two attempts at the one product demonstration:

TASK #1: COMMERCE: HYPERLOOP CONSTRUCTION

TASK #2: ENTERTAINMENT: LIGHT AND WATER SHOW MAINTENANCE

TASK #3: HEALTH: ENVIRONMENTAL CLEANUP

TASK #4: SAFETY: RISK MITIGATION

The product demonstration score will be added to your [ENGINEERING & COMMUNICATION](#) and [SAFETY](#) scores to determine your total, overall score for the competition.

SCORING OVERVIEW

The competition consists of product demonstrations, technical documentation, product presentations, marketing displays, and safety with the following scoring breakdown:

- **Product demonstrations)**
 - 260 points (max), plus a time bonus
 - Size and weight restrictions
 - 40 points (max)
 - Product demonstration safety and organizational effectiveness
 - 20 points (max)
- **Engineering & Communication**
 - Technical documentation
 - 100 points (max)
 - Product presentations
 - 100 points (max)
 - Marketing displays
 - 50 points (max)
 - Company Spec Sheet
 - 20 points (max)
 - Outreach and Inspiration
 - 10 points (max)
- **Safety**
 - Initial Safety Inspection
 - 10 points (max)
 - Safety Inspection
 - 30 points (max)
 - Analysis (JSAs)
 - 10 points (max)

TOTAL POINTS = 650

TIME

Each product demonstration includes:

- 5 minutes to set up at the product demonstration station
- 15 minutes to attempt the tasks
- 5 minutes to break down and exit the product demonstration station

Your company will have 5 minutes to set up your system, 15 minutes to complete the tasks, and 5 minutes to

demobilize your equipment and exit the product demonstration station. During the 5-minute set-up, you may reassemble your vehicle after the size determination and weigh-in and place it in the water for testing and/or trimming purposes. The 15-minute demonstration period will begin after the full 5 minutes of set up time expires, regardless of whether the company is ready to start the product demonstration. It may begin sooner if your CEO notifies the product demonstration station judges that your company is ready to begin.

At any time during the demonstration, you may pilot your ROV to the surface and remove the vehicle from the water for such things as buoyancy adjustments, payload changes, and troubleshooting, but the 15-minute product demonstration clock will only be stopped by a judge who determines it is necessary for reasons beyond your control. Otherwise, the clock will only stop after all of the tasks are successfully completed, the ROV has returned to the surface under its own power so that it touches the side of the pool, and a company member at the product demonstration station has physically touched the vehicle. Your ROV is not required to return to the surface between tasks.

Your 5-minute demobilization will begin as soon as the 15-minute demonstration time ends, regardless of where your ROV is located (i.e., still at depth, on the surface, etc.).

TIME BONUS

Companies will receive a time bonus for each product demonstration if you:

- 1) successfully complete all the tasks,
- 2) return your ROV to the surface under its own power so that it touches the side of the pool, and
- 3) physically touch your vehicle before the demonstration time ends.

Companies will receive 1 point for every minute and 0.01 point for every second under 15 minutes remaining.

EXPLORER CLASS DEMONSTRATION – *NOTE CHANGES IN 2017!!!*

All EXPLORER class companies are required to submit a video that:

- Demonstrates the ability of their vehicle to perform specific tasks;
- Shows compliance with MATE's design and build specifications.

New in 2017!!!

Video specifications: The video **MUST** show the following ROV features for the specified amount of time. Companies can narrate the video to better explain how their vehicle meets these required specifications.

The video **MUST** show in this order:

1. 15 seconds (or more) of the 48-volt power supply (**ELEC-002E**).
2. 15 seconds (or more) showing a properly sized fuse or breaker. The company **MUST** use a ruler to show that this fuse or breaker is within 30 cm of Anderson Powerpole connectors. (**ELEC-008E, ELEC-010E**).

3. 30 seconds (or more) of the inside of the control box showing the wiring and components. MATE will be looking for:
 - o No exposed wiring **(ELEC-017E)**.
 - o That the control box is neatly laid out with attention to workmanship. **(ELEC-022E)**.
 - o Separation and identification of 120VAC wiring from DC and control voltages. **(ELEC-023E)**.
4. 15 seconds (or more) showing wires entering and leaving control systems and strain reliefs for those wires and tether. **(ELEC-024E)**
5. 15 seconds (or more) in the control system showing that there is no conversion of the 48V until it reaches the ROV. Power supplies, ESCs, H-Bridges or other voltage conversion devices are not allowed on the surface. **(ELEC-003E & ELEC 004E)**
6. 30 seconds (or more) showing any hydraulic / pneumatic systems including a pressure release valve and regulator in the system **(FLUID-007, FLUID-011)**, and that any pressurized cylinder, pressure storage device meets the MATE specifications of **(FLUID-012, FLUID-013)**. In addition, the type of fluid should be clearly stated in the video **(FLUID-002, FLUID-003, FLUID-004)** If the vehicle does not use fluid power, **you should video a slide stating that Fluid Power is not used on this ROV for 10 seconds.**
7. 60 seconds (or more) total, 10 seconds (or more) per side of the ROV (4 sides plus top and bottom) showing that all motors are waterproofed and propellers are shrouded. There are no sharp edges or elements of the ROV that could cause damage **(MECH-006, ELEC-017E)**.

Video demonstrating specific tasks: Following those requirements, the video must demonstrate that the ROV can complete the **Entertainment** product demonstration task. The ROV must complete the entire task within 15 minutes.

The UNCUT video must show the vehicle:

1. Launching safely from the side of the pool and maneuvering to the platform.
See specifications **(MECH-004 & MECH-005)**.
2. Completing the entire **Entertainment: Light and Water Show Maintenance** task. This includes:
 - a. Disconnecting the power cable from the platform.
 - b. Turning the valve to stop the flow of water to the platform.
 - c. Disengaging the locking mechanism at the base of the fountain.
 - d. Removing the old fountain.
 - e. Installing the new fountain.
 - f. Re-engaging the locking mechanism at the base of the fountain.
 - g. Turning the valve to restore the flow of water to the platform.
 - h. Reconnecting the power cable to the platform.
 - i. Returning the old fountain to the surface, side of the pool.

The camera angle must demonstrate that the ROV is under its own power and not being guided by human assistance when in the water. The MATE Center requires that the camera show the complete ROV in the field of view at all times. A video that cuts between camera angles will not pass the demonstration requirement as the MATE Center requires “uncut” footage. The video is permitted to show a split screen or may incorporate a

separate window showing the ROV camera or other footage. However, the video MUST show an uncut view of the vehicle from launch to completion of the task. The task must be completed within 15 minutes.

Companies must follow the product demonstration order as laid out in the product demonstration task mission notes.

Videos must be submitted no later than 11:59 PM, Hawaii time, May 13th, 2017. Videos must be submitted via the form located here – <https://www.emailmeform.com/builder/form/IFKbdLUvk3e1V>, using the following naming convention: School or organization name_company name_video demonstration_2017.

Companies may submit the specification and product demonstration as two separate videos. Note that the product demonstration portion must be a complete, uncut video.

- Videos must be submitted as .mp4 or .wmv files.
- Videos file size is limited to 10MB per video.

MATE competition organizers will review the videos and respond by May 27th. Video submissions will NOT be accepted after May 13th – NO EXCEPTIONS. If the video does not clearly demonstrate that the company's vehicle meets the specifications and accomplishes the tasks, the company is not eligible to participate in the international competition. No extensions past the due date will be given for any reason.

MATE strongly encourages companies to submit their videos well before May 13th. That way, if an issue is found, companies will have the opportunity to address the issue and submit an updated video before the May 13th deadline. Note that it may take MATE up to 5 working days to evaluate a video submission.

In addition to submitting a video, EXPLORER class companies may be asked to attend the regional competition that is geographically closest to them to demonstrate their vehicle and/or assist with the event.

Regional competitions benefit from the participation of EXPLORER class companies by:

- Showcasing EXPLORER ROVs to RANGER, NAVIGATOR and SCOUT class companies to help them to learn about advanced systems and get ideas for “next year”
- Inspiring RANGER, NAVIGATOR, and SCOUT students to see what's possible if they continue to progress through the competition classes
- Providing examples of educational pathways and potential post-secondary institutions and programs to continue to pursue STEM learning
- Having access to additional volunteers and judges

Companies benefit from attending the regional by:

- Having access to the product demonstration props and the opportunity to conduct a “wet” run
- Receiving feedback from safety inspectors, including identification of potential safety violations and what can be done to enhance their vehicle from a safety standpoint
- Receiving technical help from engineers and technicians as well as from other companies

- Gaining insight and sharing ideas with other companies
- Earning points for the Outreach and Inspiration portion of the competition

Regional coordinators will be reaching out to EXPLORER companies in their region. If your company has not been contacted by March 3rd, please contact the [coordinator of the regional contest](#) nearest you or the [MATE Center](#) for more information regarding your participation.

NEED

The Port of Long Beach has issued a request for proposals (RFP) for a remotely operated vehicle and crew that can operate in the sometimes confined and often precarious conditions of the port and waterfront. Specifically, the port managers are in need of an ROV that can 1) assist with the installation of a Hyperloop system to expedite the delivery of goods and streamline **commerce**; 2) conduct maintenance on the port's water and light show to guarantee uninterrupted **entertainment**; 3) identify and collect samples of contaminated sediment then remediate the area to protect the **health** of people and the environment; and 4) identify the contents of containers that fell off of a cargo ship into the harbor and map the accident site to ensure the **safety** of the port and its operations.

Before launch and operations, the ROV must complete a series of "product demonstrations" staged in the swimming pool on the campus of Long Beach City College and at various regional locations. (Depth requirements vary depending on competition class; see [VEHICLE DESIGN & BUILDING SPECIFICATIONS](#) below.) Companies that successfully complete the product demonstrations and deliver exceptional engineering and communication components (e.g. technical documentation, product presentations, and marketing displays) will be awarded the contract.

This is where your work begins.

Visit www.youtube.com/watch?v=Tn-jUbpFV4A for sound advice from MATE judge Marty Klein. He references 2015, but his words hold true for any competition season!

REQUEST FOR PROPOSALS (RFP)

1. General

a. Commerce: Hyperloop Construction

The Port of Long Beach is embarking on one of the largest, most expensive, and possibly most transformational projects in the history of shipping ports. The port is starting construction of the first-ever underwater hyperloop system designed to transport cargo. The system will allow ships to drop freight into massive hyperloop tunnels submerged miles offshore, delivering their goods without ever coming into port.

For shipping companies, it will make delivery of goods much more efficient. Cargo ships sometimes wait in line for days to reach port; the new system will stretch out far enough to provide as many docking points as needed. Because it will be so much faster, it will help to save money and, in doing so, ultimately make goods cheaper.

It could also dramatically reduce pollution. While ships wait in line, they typically spew smog into nearby neighborhoods. Combined, the Ports of Los Angeles and Long Beach are the largest complex in the country; children in Long Beach also have the highest rates of asthma. Keeping ships farther offshore would help. Moving ports offshore would also free up beautiful coastline areas for parks and beaches rather than acres of cranes.



Concept drawing of an underwater hyperloop system. <http://inhabitat.com/hyperloop-one-plans-to-take-supersonic-transportation-underwater/>

A survey of the seafloor has been completed and beacons to help with navigation and positioning of the underwater structure have been placed at predetermined locations. With these tasks completed, the construction phase is ready to begin.

b. Entertainment: Light and Water Show Maintenance

The Port of Long Beach has invested time and money to attract tourists and other visitors – along with their wallets – to the waterfront. In addition to the RMS Queen Mary, the harbor includes tours of the Russian Scorpion submarine, creatures of the deep at the Aquarium of the Pacific, and the newest attraction, a water and light show designed to be visible from the dock or while dining at one of the many restaurants along the waterfront.

With its kaleidoscope of colors, fanciful music, and more than 1,000 fountains shooting water 100 feet into the air, the port's water and light show, *a-MATE-zing*, is a spectacular blend of art and technology. It is also a hugely popular nighttime attraction, which makes maintaining it to ensure uninterrupted operation a priority.

The show is due for routine maintenance. Specifically, one of the water fountains needs to be removed and replaced. The fountain is located in the center of the show's primary platform.



A colorful water and light show. <http://42ndclass.com/wp-content/uploads/2014/08/lima-water-show-fountains-12.jpg>

c. Health: Environmental Cleanup

As a consequence of over 50 years of shipping and industrial uses by the U.S. Navy's Long Beach operations, high concentrations of contaminants including heavy metals (copper, lead, mercury, silver and zinc), DDT, and PCBs were measured in sediments collected from the Installation Restoration (IR) Site 7 area in the Port of Long Beach. Because of the potential ecological risks to benthic organisms, the port and its partners – Base Realignment and Closure (BRAC) Clean-up Team, U.S. Fish and Wildlife Service, California Department of Fish and Game, National Marine Fisheries Service, Restoration Advisory Board, and the Army Corps of Engineers – launched an environmental remediation project to remove contaminated sediments from the area.

Remediation of the site focused on dredging and removing the harmful sediments. Once removed, the sediments were taken to the Pier G fill site, which was designed to effectively contain chemically impacted sediment and to control water runoff as these sediments settle.

If higher than background levels of contaminants are found, this time the remediation technique will involve capping, rather than dredging, the contaminated area. A layer of gravel, rock, and sediment will be placed on the top of contaminated area to contain the sediment and limit interaction between the contaminants and marine life.

d. Safety: Risk Mitigation

The Port of Long Beach handles 82.3 million metric tons of cargo each year; the loaded containers passing through the port account for nearly one in five containers moving through all U.S. ports. The ability to monitor and track these containers while at sea and in port is extremely important to ensuring the safety and security of the port, its operations, and its people.

The Port of Long Beach began a pilot program of tracking containers using active Radio Frequency Identification or RFID technology. Cargo containers are outfitted with RFID tags, which are transponders that hold digital information on a microchip. A reader or “interrogator” activates the transponder using radio waves. Once activated, the transponder transfers its data to the reader. Because radio waves do not travel well through salt water, the transponder and reader must be close to each other to communicate.

A civilian boater moving reported seeing cargo containers fall off of a freighter as it was leaving the port during the night. The boater was unable to identify the ship, but did provide a GPS estimate of where the ship was located when the containers fell. That location is approximately 750 meters south of the West End Long Beach Breakwater opening and at the edge of heavy traffic lanes where the water depth varies between 16 to 25 meters. The boater also provided a dark, grainy cellphone photo of the containers sinking into the water.

Port security and the U.S. Coast Guard have been called in to investigate. Given vessel traffic and the supposed location of the incident, the idea of deploying SCUBA divers is out of the question. They need assistance finding the cargo containers, determining their contents, and mapping the incident site.

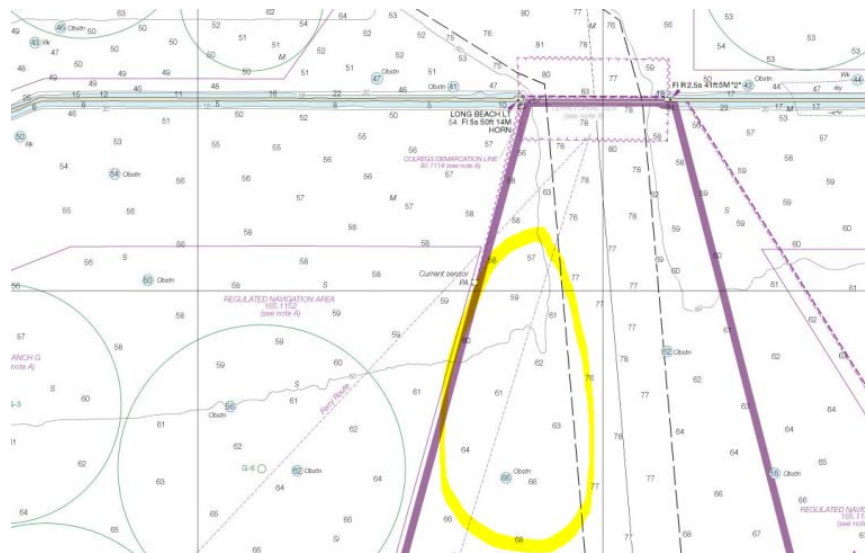

Chart of waters around the West End Long Beach Breakwater opening with container search area highlighted. www.charts.noaa.gov/OnLineViewer/18751/shtml

e. Document Scope and Purpose

This and the following sections contain the technical specifications and requirements for ROV services needed to support the Port of Long Beach. In 2017, ROV services include:

1) COMMERCE: HYPERLOOP CONSTRUCTION

- Inserting two rebar reinforcement rods into position in the steel baseplate.
- Installing the frame onto the baseplate.
- Removing a pin to release the chains holding the frame.
- Transporting and positioning the hose for pouring concrete into the frame.
- Retrieving the three positioning beacons and returning them to the surface.

2) ENTERTAINMENT: LIGHT AND WATER SHOW MAINTENANCE

- Disconnecting the power cable from the platform.
- Turning the valve to stop the flow of water to the platform.
- Disengaging the locking mechanism at the base of the fountain.
- Removing the old fountain.
- Installing the new fountain.
- Re-engaging the locking mechanism at the base of the fountain.
- Turning the valve to restore the flow of water to the platform.
- Reconnecting the power cable to the platform.
- Returning the old fountain to the surface, side of the pool.

3) HEALTH: ENVIRONMENTAL CLEANUP

- Using a simulated Raman laser to determine if contaminants are present in two sediment samples.

- Collecting a 150 ml sediment sample from the contaminated area and returning it to the surface. The sediments will be simulated by agar.
- Collecting two clams from the contaminated area and returning them to the surface.
- Placing a cap over the contaminated sediments.

4) SAFETY: RISK MITIGATION

- Locating the four cargo containers.
- Activating each container's RFID and obtaining Bluetooth data from the container.
- Using the Bluetooth data to determine the contents and if the contents are high risk.
- Attaching a buoy marker to the U-bolt on the container with high-risk cargo.
- Determining the distance and direction from the high-risk container to the other three containers.
- Using distance and direction to make a survey map of the incident site.

2. Specifications

See the specific tasks described below as well as the [VEHICLE DESIGN & BUILDING SPECIFICATIONS](#) and [COMPETITION RULES](#) sections.

3. Maintenance and Technical Support

The company shall warrant the ROV and associated systems and equipment for at least the duration of the product demonstrations. Repair or replacement shall be at the company's expense, including the cost of shipping the ROV to and from the competition facility.

4. Shipping and Storage

Refer to [Shipping Information](#) for specifics on shipping to the international competition site.

Delivery of the ROV and associated systems and equipment shall be no later than the date of the geographically closest regional contest or by June 23, 2017, which is the start date of the international competition.

5. Evaluation Criteria

- Technical documentation
- Product presentation
- Marketing display
- Product demonstration

6. References

a. GENERAL

- www.polb.com/about/facts.asp
- https://en.wikipedia.org/wiki/Port_of_Long_Beach
- www.legendsofamerica.com/ca-queenmary.html
- <http://ascelibrary.org/doi/abs/10.1061/9780784413067.019>

b. COMMERCE

- i. <https://hyperloop-one.com/what-is-hyperloop>
- ii. <https://www.fastcoexist.com/3062709/imagine-a-hyperloop-that-uses-underwater-tunnels-to-replace-cargo-ships>

c. ENTERTAINMENT

- i. <https://disneyland.disney.go.com/entertainment/disney-california-adventure/world-of-color/>

d. HEALTH

- i. <http://polb.com/civica/filebank/blobdload.asp?BlobID=6613>
- ii. <http://www.polb.com/civica/filebank/blobdload.asp?BlobID=5360>
- iii. <http://slideplayer.com/slide/4649071/>
- iv. <https://clu-in.org/contaminantfocus/default.focus/sec/Sediments/cat/Remediation/p/2>
- v. <http://www.inphotonics.com/raman.htm>
- vi. <http://www3.mbari.org/news/homepage/2004/laser-raman.html>
- vii. <http://www3.mbari.org/news/homepage/2004/laser-raman.html>
- viii. <http://www.cpeo.org/techtree/ttdescript/sedcap.htm>

e. SAFETY

- i. <http://losangeles.cbslocal.com/2015/06/02/5-cargo-containers-fall-into-water-at-port-of-la/>
- ii. <http://www.rfidjournal.com/articles/view?1965>
- iii. <http://www.rfidjournal.com/articles/view?3870>
- iv. <https://www.case.edu/does/ChemSafety/shipHazMat.html>
- v. <http://www.winmec.ucla.edu/rfid/course/2007f/Container%20Tracking%20with%20RFID%20and%20Port%20Security.pdf>

IMPORTANT NOTE: Questions about production demonstrations and design and building specifications must be posted to the competition FAQs board located at www.marinetech.org/forums/. This allows all companies to see the questions and answers and helps to avoid duplicate questions. That said, please make sure that your question(s) has not already been asked – and answered – before posting. It is up to the companies to read, comprehend, and comply with ALL rulings posted on the FAQ board.

SIZE AND WEIGHT RESTRICTIONS

The Port of Long Beach has included an ROV size and weight requirement in the request for proposals (RFP). Smaller, lighter vehicles will be given special consideration and vehicles above a certain size and weight will not be considered.

Vehicles will be measured and weighed in the EXPLORER on-deck circle 30 to 45 minutes prior to the company's product demonstration runs. Note that the vehicle will be measured and weighed before all product demonstration runs. The size and weight bonus, if any, will be added into the product demonstration score.

Size Measurements

Size measurements will be made using the two largest dimensions of the ROV. Four rings with diameters of 58 cm, 64 cm, 70 cm, and 85 cm will be located on a table in the on deck circle. Companies will place their vehicles on the table and, when ready, ask a MATE Center competition official to make the size measurement. The vehicle measurement must include the vehicle, all manipulators/tools that will be used in the product demonstration as well as the vehicle's tether. The control system and 1 meter of tether may be outside of the measurement circle. Companies may detach manipulator arms and other equipment and place that equipment, next to, on top of, or inside the vehicle frame, but all of the equipment that will be used must be present and fit within the measurement circle. For example, a company may remove a manipulator arm that extends 20 cm in front of the vehicle and place it on top of the vehicle. The measurement will be made with the arm on top of the vehicle provided that the length and width are still the largest diameters.

The ring must fit over the two largest dimensions of the ROV. If the ROV and all its equipment fit within the ring of 58 cm in diameter, the company will receive +20 bonus points. If the ROV and all its equipment fit within the ring of 64 cm in diameter, the company will receive +10 bonus points. If the ROV and all its equipment fit within the ring of 70 cm in diameter, the company will receive +5 bonus points. If the ROV and all its equipment fit within the ring of 85 cm in diameter, the company will receive no bonus points, but can still compete in the product demonstration. If the ROV and all its equipment do not fit within the 85 cm in diameter ring, the company will not be permitted to compete in that product demonstration run.

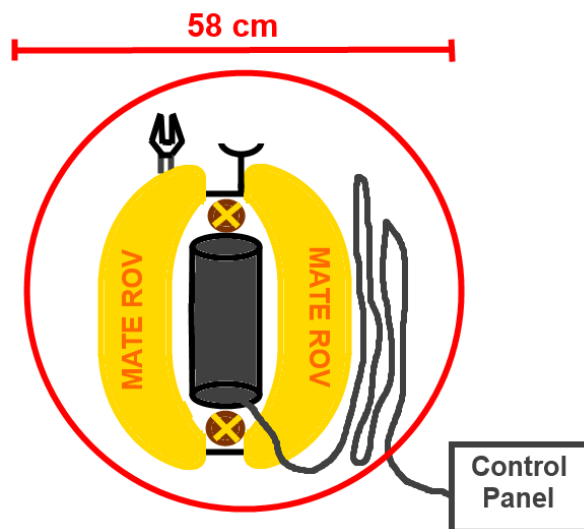

An EXPLORER class vehicle, with tools attached and tether coiled beside the ROV, inside the 58 cm diameter ring. This vehicle would earn the company +20 bonus points on the product demonstration score.

Weight Measurements

Weight measurements will be conducted using a digital scale. If the ROV, including its tether, weighs 17.0 kg or less, the company will receive +20 bonus points. If the ROV weighs between 17.01 kg and 19.0 kg, the company will receive +10 bonus points. If the ROV weighs between 19.01 kg and 22.0 kg, the company will receive +5 bonus points. If the ROV, including its tether, weighs between 22.1 kg and 25 kg, the company will

receive 0 bonus points, but will still be allowed to compete. An ROV weighing more than 25 kg will not be allowed to compete in the product demonstration. NOTE: The control system and 1 meter of the tether may be placed on the table below the ROV and not included in the weigh-in.

In addition, companies must be able to personally transport the vehicle and associated equipment to the product demonstration station and to the product presentation room. ROV systems must be capable of being safely hand launched.

Hand powered lifts and levers and tether management systems may be used with the vehicle. Hand powered lifts and levers will not count towards the size or weight of the ROV. Tether management systems that can be separated from the vehicle will not count towards the size or weight of the ROV.

Only the six designated product demonstration company members will be allowed into the on-deck circle during and after the measurement and weigh in. Once a company's vehicle has been measured and weighed, it must remain there until the company moves to its product demonstration station. Companies that detach equipment from the vehicle may not re-install that equipment until the 5-minute set up period. At that time, companies may replace any items that were detached for the measurement, but no new equipment (i.e., equipment that was not included in the size and weight measurements) may be added to the vehicle. If it is discovered that a company added equipment that was not included in the measurements, the company will not be permitted to compete in that product demonstration run.

Videos showing simulated size and weight measurements will be posted [here](#) by December 9, 2016.

PRODUCT DEMONSTRATION

TASK 1: COMMERCE: HYPERLOOP CONSTRUCTION

Your company is tasked with inserting rebar reinforcement rods into the center of a steel baseplate that has already been placed on the seafloor. Your ROV will then serve as the “eyes” for you and your teammates as you lower the frame for the concrete onto the baseplate; your ROV will need to assist with the placement of the frame. Once in place, your ROV must remove a pin to release the chains that are holding the frame from the surface. Then your ROV must transport and position the hose for pouring concrete into the center of the frame. Finally, you must retrieve the positioning beacons and return them to the surface.

This task involves the following steps:

- **Inserting two rebar reinforcement rods into position in the steel baseplate – 5 points each (10 points total)**
- **Installing the frame onto the baseplate – 20 points**
- **Removing a pin to release the chains holding the frame – 5 points**
- **Transporting and positioning the hose for pouring concrete into the frame – 10 points**

- **Retrieving the three positioning beacons and returning them to the surface – 5 points each (15 points total)**

TOTAL POINTS = 60

Product Demonstration Notes:

Companies must complete the steps of Task 1: Commerce: Hyperloop Construction in order. Companies may not skip a step of this task. Companies may alternate between the steps of the Commerce: Hyperloop Construction task and the other product demonstration tasks.

Companies must insert two rebar reinforcement rods into position in the steel baseplate. The steel baseplate will be constructed out of ½-inch PVC pipe. The rebar reinforcement rods must be inserted into 1-inch PVC pipe sockets located in the center of the baseplate. Four lengths of 3/8-inch rebar will be located on an elevator platform within 1 meter of the steel baseplate. Any two of the four rods can be inserted into position. Companies will receive 5 points each, 10 points total for successfully inserting the two rebar rods into position on the steel baseplate. A successful insertion is the rod no longer in contact with the ROV and within the 1-inch PVC pipe.

Once both rebar rods are successfully positioned, companies must install the frame onto the baseplate. A length of ½-inch PVC pipe extend 12 cm upwards at each corner of the square baseplate. The frame will be constructed from 1 ½-inch pipe with a pair of 1 ½-inch tees at each corner. Lengths of #100 chain will be attached to each corner of the frame. These lengths will connect to a 1-inch PVC coupling and a rope leading to the surface. When lowered from the surface, the openings of these 1 ½-inch tees will fit over the ½-inch lengths of pipe in each corner of the steel baseplate. A company member on the side of the pool will act as a crane operator, raising, lowering, and manipulating the frame to fit over the baseplate. The ROV must supervise this process, and is permitted to assist the crane operators on the surface. The pilot may instruct the crane operator on which direction to move or twist the ropes holding the frame and whether to raise or lower the frame. The ROV may bump the frame to move it, but the ROV is not allowed to grab and move the frame itself. Companies will receive 20 points when the frame is successfully installed on the baseplate.

When the frame is successfully installed, companies must pull a pin to release the chains attached to each corner of the frame. The pin will be constructed from a galvanized steel tent peg. It will be pushed through one hole in the 1-inch PVC coupling, through the links of the four chains attached to each corner of the frame, and out through a second hold in the 1-inch PVC coupling. Companies will receive 5 points when they successfully pull the pin from coupling. Successfully pulling the pin is defined as the pin no longer in contact with PVC coupling. Companies may return the pin to the surface or place it on the pool bottom. When the chains have been released from the frame, the rope and remaining chains can be returned to the surface.

The frame will weigh up to 25 Newtons in water.

After pulling the pin and releasing the chains attached to the frame, companies must position the hose for pouring concrete inside the frame. The hose will be constructed from garden hose with a 1-inch PVC cross at

the end. A #310 U-bolt will be attached to the cross and will serve as a grab point. The hose will be pre-positioned on the bottom, within 1 meter of the baseplate. Companies will receive 10 points when they successfully position the end of the hose inside the frame. A successful positioning is defined as the 1-inch cross no longer in contact with the ROV and inside the 2-inch PVC of the frame. The hose must stay in position for 10 seconds after the ROV releases it.

The final step of this task is to retrieve the three positioning beacons located around the construction site and return them to the surface. The positioning beacons will be constructed from 1 ¼-inch PVC couplings. Two Velcro strips will be attached to the outside of the coupling. Companies will receive 5 points each, 15 points total, when they return the positioning beacons to the surface, side of the pool.

The positioning beacons will weigh less than 5 Newtons in water.

TASK 2: ENTERTAINMENT: LIGHT AND WATER SHOW MAINTENANCE

Your company is tasked with piloting your ROV to the platform to disconnect the power cable and turn a valve to stop the flow of water. Then you must pilot your ROV underneath the platform to disengage the locking mechanism at the base of the fountain. Once the lock is disengaged, you must pilot your ROV to the topside of the platform to remove the old fountain and install a new fountain. After installing a new fountain, you must pilot your ROV under the platform to re-engage the locking mechanism. Then you must reconnect power cable and turn the valve to restore the flow of water. You must also return the old fountain to the surface.

This task involves the following steps:

- **Disconnecting the power cable from the platform – 5 points**
- **Turning the valve to stop the flow of water to the platform – 10 points**
- **Disengaging the locking mechanism at the base of the fountain – 5 points**
- **Removing the old fountain – 5 points**
- **Installing the new fountain – 5 points**
- **Re-engaging the locking mechanism at the base of the fountain – 5 points**
- **Turning the valve to restore the flow of water to the platform – 10 points**
- **Reconnecting the power cable to the platform – 10 points**
- **Returning the old fountain to the surface, side of the pool – 5 points**

TOTAL POINTS = 60

Product Demonstration Notes:

Companies must first disconnect the power cable and turn the valve to stop the flow of water. These two steps may be done in any order, but must be completed before continuing to the other steps of this task. Companies must then disengage the locking mechanism at the base of the fountain, remove the old fountain, install the new fountain, and re-engage the locking mechanism at the base of the fountain. These four steps must be done in order. After the base of the new fountain has been locked in place, companies must turn the

valve to restore the flow of water and reconnect the power cable. These two steps may be done in any order. Companies must also return the old fountain to the surface. Returning the old fountain to the surface may be done at any time after removing it from the platform. Companies may alternate between the steps of the Entertainment: Light and Water Show Maintenance task and the other product demonstration tasks.

The entertainment platform will be constructed out of a PVC frame with corrugated plastic attached to the top and one side. The framework will rest on the bottom of the pool. The platform will be approximately 2 meters long, 1.15 meters wide and 1 meter tall. ROVs will have to work around, above, and inside the platform framework.

Companies must disconnect the power cable from the platform and turn the valve to stop the flow of water to the platform. The power cable will be located on the outside, bottom corner of the platform frame. The valve will be located on the outside perimeter of the platform frame as well. These two steps can be done in either order.

The power cable connector will be constructed of 1 ½-inch PVC pipe and a 1 ½-inch PVC cross. A 2 meter length of 18-gauge red/black power wire will be attached to the connector. Both a screw hook and a screw eye will act as grab points on the cable connector, but companies may move the power cable connector by any method they wish. The port for the connector will be constructed from 2-inch PVC pipe. The port will be positioned horizontally, i.e. it will be parallel to the bottom of the pool. At the start of the product demonstration, the cable connector will be inserted into the port. Companies must disconnect the power cable from the platform by pulling the connector out of the port. Companies will receive 5 points when the cable connector is no longer touching the 2-inch PVC of the port. Companies may leave the power cable connector anywhere (e.g. on the pool bottom, in a collection basket on the ROV) they wish once it is successfully disconnected.

The power cable connector will weigh less than 10 Newtons in water.

The valve will be constructed of a ½-inch gate valve and will be built into the ½-PVC framework of the platform. The valve will be positioned vertically (perpendicular to the pool bottom) and located approximately 45 cm above the bottom of the pool. Companies will receive 10 points when they turn the valve to stop the flow of water. Companies must turn the valve clockwise 1080°, approximately 3 times around, to successfully stop the flow of water. A black mark on the valve handle will verify the number of rotations of the valve. No actual water will be running through the valve or pipes.

To access the locking mechanism, companies will have to maneuver underneath and inside the structure of the platform framework. Once inside the platform framework, companies must disengage the locking mechanism at the base of the fountain. The locking mechanism will be constructed of a 1-inch PVC cross and ½-inch PVC pipe. To disengage the locking mechanism, companies must turn the ½-inch PVC handle 180°. Companies will receive 5 points for unlocking the base of the fountain.

Companies must then exit the platform framework, remove the old fountain and install the new fountain. At the start of the product demonstration, the old fountain will be located on the top of the platform, resting on the corrugated plastic sheet. The new fountain will be located at the surface, side of the pool and can be attached to the vehicle during the 5-minute set up period. Both fountains will be constructed from a 3-inch to 2-inch ABS reducer bushing with four 1/2-inch end caps attached to the top. The old fountain will be positioned over a 1-inch end cap screwed into the topside of the corrugated plastic. Companies will receive 5 points for removing the old fountain. Removing the old fountain is defined as the old fountain no longer in contact with the 1-inch PVC end cap that it rests on. Companies will receive 5 points when they install the new fountain. Installing the new fountain is defined as the fountain no longer in contact with the ROV, resting over the 1-inch PVC end cap and flush with the corrugated plastic topside of the platform. The new fountain must be transported by the ROV.

Fountains will weigh less than 10 Newtons in water.

Once the new fountain is installed, companies must maneuver underneath and inside the structure of the platform framework and re-engage the locking mechanism at the base of the fountain. To re-engage the locking mechanism, companies must turn the 1/2-inch PVC handle 180° back to its original, locked position. Companies will receive 5 points when they successfully re-engage the locking mechanism at the base of the fountain.

After re-engaging the locking mechanism, companies must reconnect the power cable to the platform and turn the valve to restore the flow of water to the platform. These two steps can be done in either order.

Companies must retrieve the power cable connector, and insert it into the 2-inch PVC port. Companies will receive 10 points when they successfully insert the power cable connector into the port. A successful installation is defined as the 1 1/2-inch cross on the cable connector positioned flush against the 2-inch pipe of the port. The cable connector must stay inside the port until all steps of this task are complete. If this is the final step of the task, the connector must stay inside the port for 5 seconds after being released by the vehicle to count as a successful insertion.

Companies must turn the valve to restore the flow of water to the platform. The valve must be turned counter-clockwise 1080°, approximately 3 times around, to restore the flow of water to the platform. Companies will receive 10 points when they successfully turn the valve handle back to the fully on position. One 20 cm length of PVC pipe attached to the valve will be painted red to verify the number of rotations of the valve.

Companies must return the old fountain to the surface, side of the pool. This step may be done at any time after the old fountain is removed from the platform. Companies will receive 5 points when the old fountain is returned to the surface, side of the pool.

TASK 3: HEALTH: ENVIRONMENTAL CLEANUP

Before the competition, your company is tasked with simulating a Raman spectrometer using either a laser or light. At the competition, you are tasked with using your simulated Raman Laser to illuminate areas of sediment to determine if it is contaminated. Provided that you are able to illuminate the area, you will be given simulated Raman spectra to analyze and help you determine which area is contaminated. Once you have determined which area is contaminated, you must collect a sediment sample and two crabs. Finally, you must remediate the contamination by placing a cap over the area.

This task involves the following steps:

- **Using a simulated Raman spectrometer to determine if contaminants are present in two areas – 5 points.**
- **Collecting samples from the contaminated area**
 - **Collecting two clams from the contaminated area and returning them to the surface – 5 points each (10 points total).**
 - **Collecting a sediment sample from the contaminated area and returning it to the surface – up to 30 points**
 - **150 ml or more of agar – 30 points**
 - **Less than 150 ml but more than 10 ml – 10 points**
 - **less than 10 ml of agar – 0 points**
- **Placing a cap over the contaminated area – 15 points**

Total points = 60

Product Demonstration Notes:

Companies must first use a simulated Raman spectrometer to determine if contaminants are present in two areas on the pool bottom. Only one of the areas will be contaminated. Once the contaminated area is identified, companies must collect a sediment sample and two clams from that area. These collection steps may be done in either order; companies may collect the sediment sample first then the clams or vice versa. Companies must place a cap over the contaminated area. Companies may return the sediment sample and clams to the surface either before or after capping the contaminated area. However, once the cap is placed, no additional samples can be collected. Companies may alternate between the steps of the Health: Environmental Cleanup task and the other product demonstration tasks.

Companies must create or otherwise provide their own simulated Raman spectrometer. Companies may simulate the Raman spectrometer with a laser or with a bright light (LED or otherwise). Any laser or light must emit a colored light. The laser or light must have an on/off switch. This switch must be on the surface controller. The laser or light must be powered from the MATE surface power supply. Companies using lasers must follow all the laser safety rules.

Two sediment samples simulated by a container of agar will be located on the pool bottom. Companies must illuminate the agar inside the cup with their laser or light. The product demonstration judge must be able to determine that the laser or light has been turned on and is illuminating the agar.

The product demonstration judge will have two Raman spectrums at the start of each product demonstration, one representing each sediment area. Once a sample has been successfully illuminated by the simulated Raman laser, the product demonstration judge will provide companies with the Raman spectrum for that area. In addition, companies will have access to the following chart:

<u>Chemical contaminant</u>	<u>Main Peak (cm⁻¹)</u>	<u>Sub Peak(s) (cm⁻¹)</u>
Arsenic Sulfide	385	420
Cadmium Sulfide	520 – 540	
Copper Oxide	297	
Diamond	1332	
Lead	1054	
Mercury	547	435
PCBs	1590	1575

Companies must evaluate the two spectra and the chart to determine which area is contaminated and identify the contaminant(s). Companies will receive 5 points when they determine which of the two areas is contaminated and what the chemical contaminant(s) is from that area.

Note: Diamonds are used as reference peaks in spectra from unknown sources. The spectra will have a diamond spike for reference purposes.

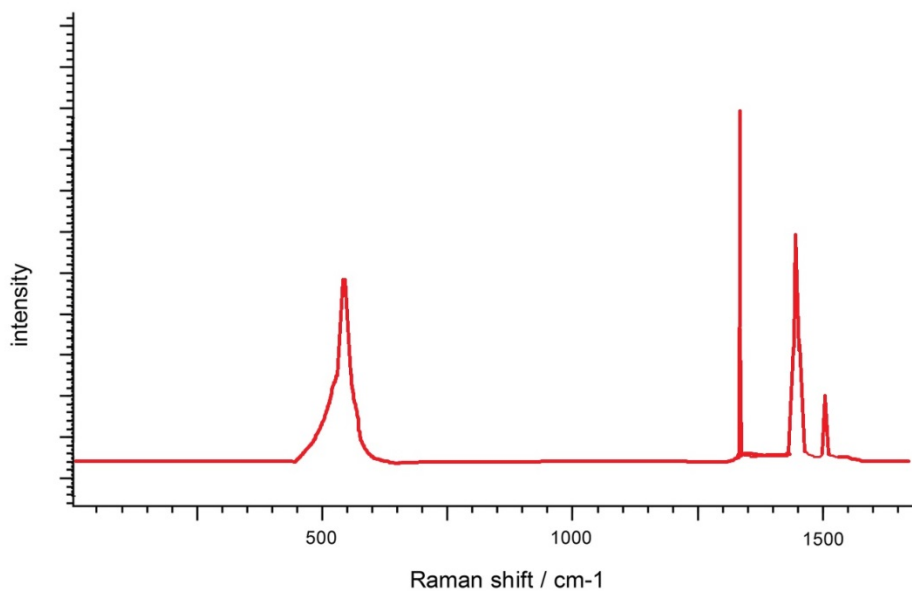

Raman spectrum of sediment contaminated with CdS (520-540 cm⁻¹) and DDT (1450 cm⁻¹, 1505 cm⁻¹). Note the diamond peak (1332 cm⁻¹).

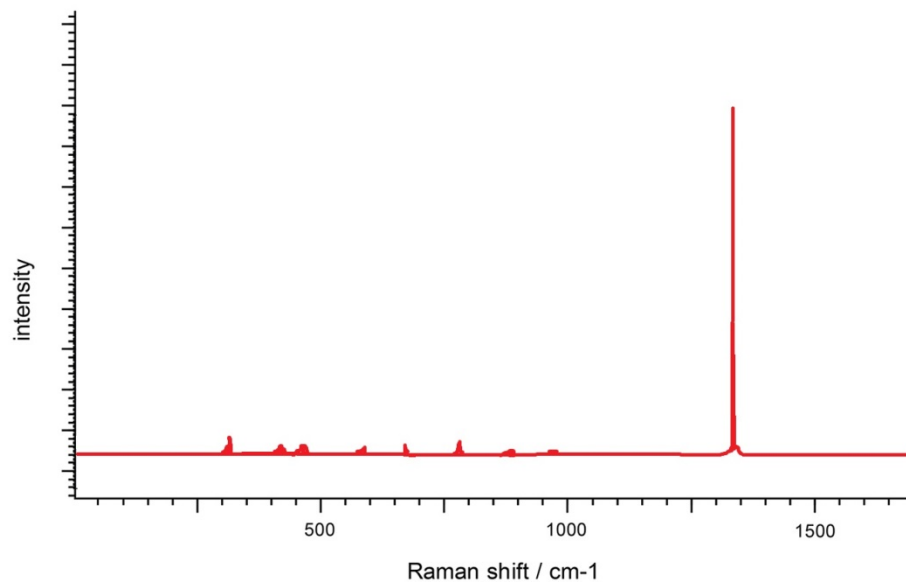

Raman spectrum of uncontaminated sediment. Note the diamond reference (1332 cm⁻¹).

Once the contaminated area has been determined, companies must collect two clams and a sediment sample from that area. Clams will be simulated by rings constructed from 1 ½-inch pipe or 1 ¼-inch PVC couplings. 25 or more clams will be piled randomly in rectangle constructed from ½-inch PVC pipe. Companies must return two clams to the surface, and will receive 5 points for each, 10 points total. Companies may return more than two clams, but will only get 10 points total for returning clams.

Clams will weigh less than 5 Newtons in water.

Companies must also return a sample of sediment to the surface. The sediment will be simulated by agar. The agar will be in a 560 ml plastic container. Companies will receive 30 points if they return 150 ml or more of agar to the surface, 10 points if they return less than 150 ml but more than 10 ml of agar to the surface, and 0 points if they return less than 10 ml of agar to the surface. Companies that collect less than 150 ml of agar can choose to attempt to collect another sample. However, if a company chooses to return to attempt to collect another sample, the first sample must be discarded; only the second sample will be measured and scored. Companies can choose to attempt to collect as many samples of agar to obtain 150 ml.

Graduated beakers will be provided by the MATE Center.

The final step of the task is to place a cap over the contaminated area. The cap will be simulated by a 60cm by 40 cm plastic tote lid. A 1-inch PVC handle can be used to lift and move the cap. The cap will be located on the surface, side of the pool during set up, and can be attached to the ROV during set up. The cap must be brought down from the surface and placed over the clam bed. Companies will receive 15 points when the cap

is successfully placed over the clam bed. Successfully placing the cap is defined as the entire clam bed (PVC rectangle) covered by the cap.

The cap will weigh less than 10 Newtons in water.

TASK 4: SAFETY: RISK MITIGATION

Your company is tasked with searching the area to locate the cargo containers. The containers became buried in the silt upon impact with the seafloor, obscuring any warning labels and making the Radio Frequency Identification (RFID) tag the only way to identify and determine their contents.

Once found, you must activate the RFID tag and determine each container's identification number. From there, you must match the identification numbers to a manifest of cargo containers to determine if the contents are high risk. You must also map the site and attach a buoy marker to the container with the highest-risk cargo.

This task involves the following steps:

- **Locating the four cargo containers – 5 points**
- **Determining the contents and risk-level of each container (up to 40 points):**
 - **Activating each container's Radio Frequency Identification (RFID) – 5 points each (20 points total)**
 - **Obtaining the container's RFID information via Bluetooth, and use the container identification number provided to determine the container's contents, and if the contents are high risk – 5 points each (20 points total)**
- **Attaching a buoy marker to the U-bolt on the container with the highest-risk cargo – 10 points**
- **Determining the direction and distance, within 10 cm, from the highest-risk container to the other three containers – 5 points each (15 points total)**
- **Using the distance and direction to make a survey map of the incident site – 10 points**

Total points = 80

Product Demonstration Notes:

The steps of Task 4: Safety: Risk Mitigation may be done in any order.

Companies must locate the four cargo containers. The cargo containers will be constructed from ½-inch PVC pipe. Each cargo container will be approximately 50 cm long, 30 cm wide, and 30 cm high. Black stripes on the upper PVC framework will help to distinguish the four different containers. One container will have one black stripe on each side of the top of the container. Another container will have two black stripes on each side of the top of the container. Another container will have three black stripes on each side of the top of the container. The final container will have four black stripes on each side of the top of the container. Companies will receive 5 points when they show the product demonstration judge all four cargo containers on their video

monitor. All four containers do not have to be in view at one time, but the judge must see all 4 containers via the video monitor before the 5 points are awarded.

Companies must activate each container's RFID tag. The RFID tag will be simulated by an HC-05 Bluetooth module and a port containing a light sensor. The Bluetooth module will be located in an upper corner of the ½-inch PVC pipe framework of each container. The port will be located near each Bluetooth module. The port will be positioned horizontally (parallel to the bottom of the pool). The port will be constructed from 1-inch PVC pipe with the inside painted black. Companies must shine a light into the port to activate the light sensor. The light sensor will be located at the end of the port. When the light sensor has been successfully activated, the Bluetooth module will begin broadcasting its data. Companies will receive 5 points for activating each Bluetooth module, 20 points total.

Once each of the Bluetooth modules has been activated, companies must determine the contents of the container and identify if the contents are high-risk. The MATE HC-05 Bluetooth module will be in a waterproof container and will be set in the Master mode. The module will be broadcasting the 7-digit container identification number. Companies must have a HC-05 Bluetooth module, or other Bluetooth receiving device, set in the Slave mode to receive this 7-digit identification number. Once the identification number has been obtained, companies will use the **EXPLORER Container Manifest Handbook** to locate the container manifest corresponding to that identification number. The manifest will include the containers identification number, the contents of the container, and the hazard classification of the contents. Containers with items that pose no risk will not be marked with a hazard label. Companies will receive 5 points for successfully matching the container in the pool with its proper manifest, 20 points total. Successfully matching the container with its manifest is defined as using the container's identification number to determine the contents and the hazard classification of the contents in the container.



The Department of Environmental Health and Safety (EHS) classification chart for hazardous materials in shipping containers. <https://www.case.edu/does/ChemSafety/shipHazMat.html>

Companies must attach a marker buoy to the container with the highest-risk or most hazardous cargo. A #310 U-bolt will be attached to the top center of each container. The U-bolt will be the attachment point for the marker buoy. Companies must design and build their own marker buoy. The buoy line must attach to the #310 U-bolt, and a red or orange float must be on the surface. Other than those specifications, companies are free to design the buoy however they wish. Companies will receive 10 points when the buoy is successfully attached. Successfully attaching the buoy is defined as one end secured to the #310 U-bolt, the other end with a red/orange buoy floating on the surface.

Note: The company built marker buoy will not be included in the size and weight measurements, but must be part of the safety inspection.

Companies must also determine the distance and direction from the most hazardous container to the three other containers. The distance between containers will be measured from the top of the U-bolt on the most hazardous container to the top of the U-bolt on the other containers. No container will be further than 3.5 meters from the most hazardous container. At the international competition, the pool lines and the side walls (parallel to the lines) run directly north/south. Using the following chart, companies must determine if the other three containers lie North, Northeast, East, Southeast, South, Southwest, West, or Northwest of the most hazardous container.

North	338° to 22°
Northeast	23° to 67°
East	68° to 112°
Southeast	113° to 157°
South	158° to 202°
Southwest	203° to 247°
West	248° to 292°
Northwest	293° to 337°

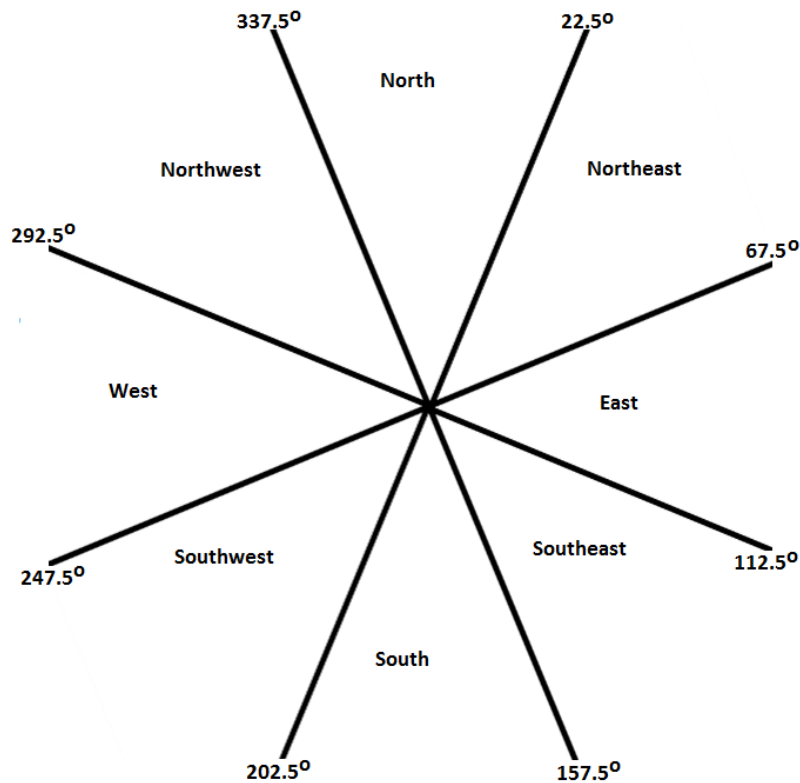

Companies do not need to show a compass to determine direction. Companies will receive 5 points for each correct distance and direction reported to the product demonstration judge, 15 points total. If a measurement is not within 10 cm of the true distance, or a direction is incorrect, the judge will inform the company. Companies can re-measure or re-evaluate direction. Companies will not receive points for completing this step, but can use the new measurement or direction for creating the map.

Once all three distances and directions have been determined, companies must make a survey map of the incident site. A blank map with 0.25 meter grid lines will be available to companies at the start of the product demonstration. Companies must draw the highest risk container at or near the center of the map, and draw the other three containers on the map at the distances and directions measured. Companies will receive 10 points for a correctly drawn survey map, e.g. with the cargo containers, measurements, and directions noted.

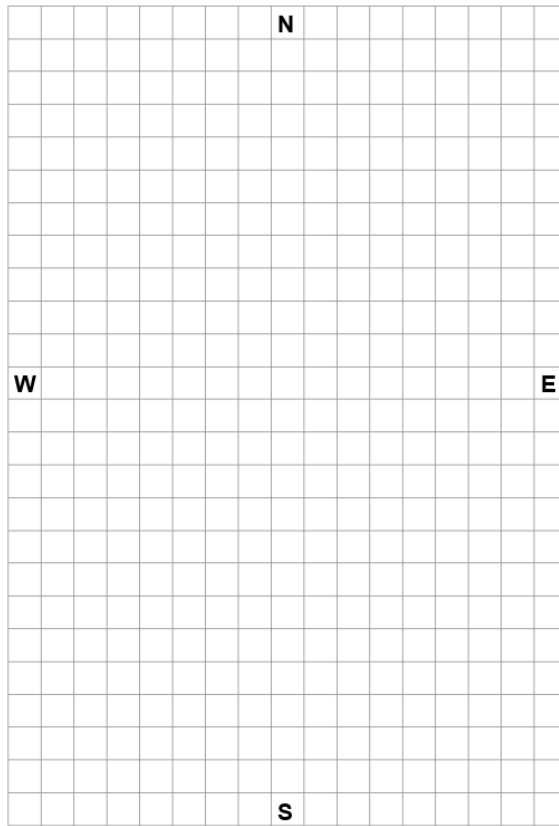

Blank map with 0.25 m gridlines and N, S, E and W.

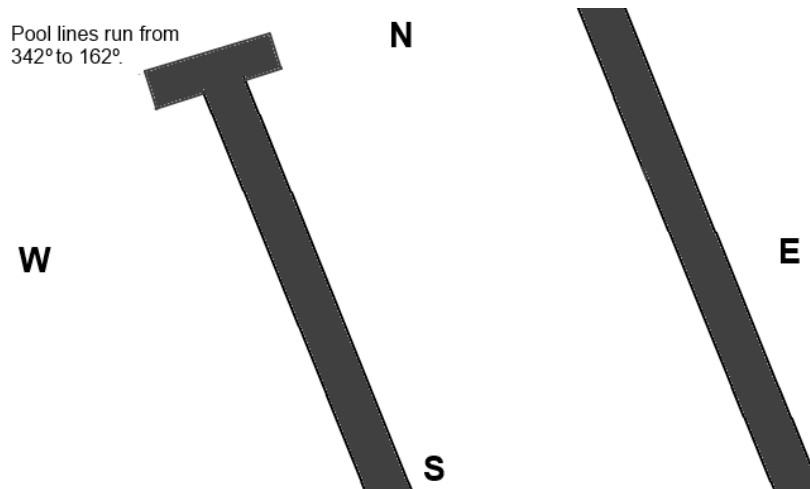

The orientation of pool lane lines. Companies will be informed the compass direction of the lane lines or other lines in the pool.

Pool lines run from 342° to 162°.

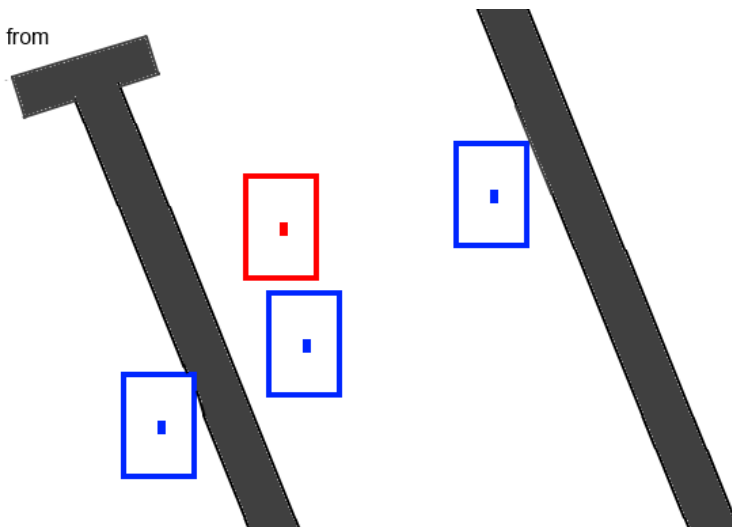

An example of the four containers located on the bottom of the pool. The red container would be the highest-risk container. Note that the containers may not be positioned in north-south orientation.

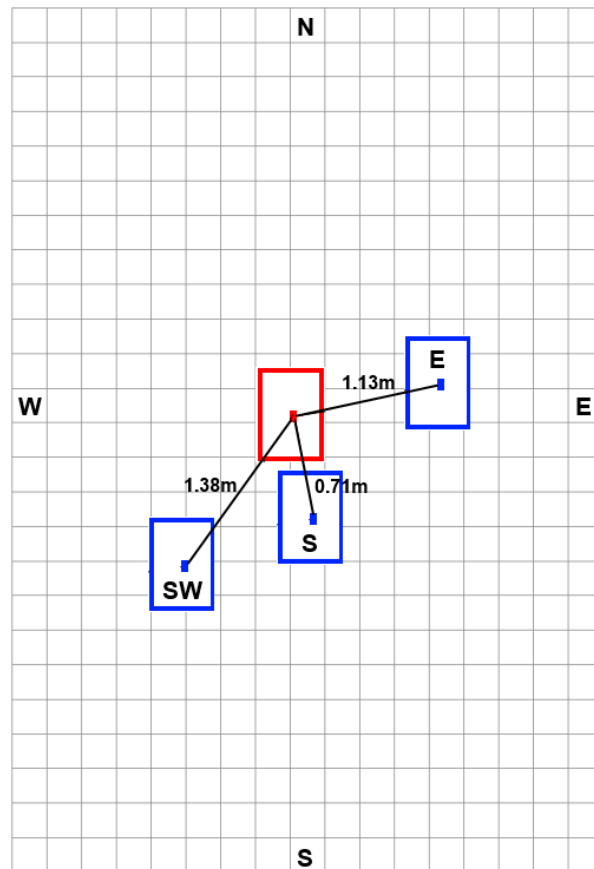

A correctly drawn survey map. In this case, using the distances and directions they calculated, companies would report: one container 1.13 m east of the highest-risk container, one container 0.71 m south of the highest risk container, and one container 1.38 m southwest of the highest risk container.

Time bonus:

If a company has successfully completed all four product demonstration tasks and is returning to the surface with positioning beacons, the old fountain, and/or clams, the product demonstration time will stop when a member of the company touches the vehicle. Beacons, the old fountain, and/or clams on board may be detached and set on the pool deck after the clock has stopped. If any of these items is subsequently dropped from the vehicle, the company will not receive points for returning the item to the surface, time will not restart, and the company will not receive a time bonus. Note: The sediment sample, simulated by agar, must be measured during the product demonstration period. If the ROV returns the sediment sample to the surface as the final step of the product demonstration, time will stop when the sample has been measured and 150 ml or more has been obtained. Companies cannot get a time bonus if they have not collected 150 ml of agar.

PRODUCT DEMONSTRATION RESOURCES

The [EXPLORER Contaminant Handbook](#) contains Raman laser spectroscopy graphs of six common, known contaminants.

The [EXPLORER Container Manifest Handbook](#) contains 10 cargo manifests that include the container identification number, the contents and the hazard class of the contents.

The [EXPLORER Product Demonstration Photos](#) contains photos of completed product demonstration props.

See the [EXPLORER Product Demonstration SolidWorks](#) files for CAD representations of the product demonstrations.

PART 2: PRODUCT DEMONSTRATION PROP BUILDING INSTRUCTIONS & PHOTOS

By popular request, this section has been removed and made into its own, separate document. This document will be released and posted by December 9th, 2016.

PART 3: VEHICLE DESIGN & BUILDING SPECIFICATIONS

1.0 GENERAL

Questions about vehicle design and building specifications, as well as competition rules, should be posted to Competition Help within the [MATE Forum Hub \(www.marinetech.org/forums/\)](http://www.marinetech.org/forums/). This ensures that all companies can view the questions and answers and helps to avoid duplicate questions. That said, companies should make sure that their questions have not already been asked – and answered – before posting. When posting their question, companies should reference the specific specification (e.g. ELEC-002R).

1.1 Glossary and Acronyms

ANSI	American National Standards Institute
Company	Teams providing a ROV System for evaluation purposes
HD	High-Definition
IEC	International Electrotechnical Commission
Instrument	A device that contains one or more sensors and a method for converting the information from the sensor into a transmittable and storable form
NEMA	National Electrical Manufacturers Association
LARS	Launch and Recovery System
Operate	Correctly performing designed functionality
PWM	Pulse Width Modulation, a method to electronically vary the effective voltage delivered to an electrical load.
SID	System Interconnection Diagram

1.2 Conventions

All values contained in this document are threshold values unless specifically stated otherwise. All water depths are given in meters (m). All dimensions and measurements utilize SI units.

1.3 Documentation Required

As part of the [Technical Documentation](#), the following SIDs are required. All diagrams must be drawn with a CAD (computer assisted drawing) program. Hand drawn figures are not permitted. All symbols must be standard symbols as specified by ANSI, NEMA, or IEC.

DOC-001: SID Electrical: One figure must be an electrical diagram for all the systems above the waterline. This diagram should show the ROV system fuse, controls, and tether connections. A second figure should be an electrical diagram showing the ROV sub-systems and their connections. Both diagrams should not exceed one page in length. The diagrams must not be component level schematics, but a higher level interconnection block type diagram. Do not include individual pins on a board; this is intended to be a higher level diagram. An example of these diagrams is an Electrical One Line Diagram. Examples of acceptable SIDs can be found here:

- www.marinetech.org/files/marine/files/ROV%20Competition/International%20Competition/2014%20Tech%20reports/EXPLORER/EXPLORER/Memorial%20University/EER_Memorial_University_Newfoundland_Tech_Report_Final_2014.pdf, page 22
- www.marinetech.org/files/marine/files/ROV%20Competition/International%20Competition/2014%20Tech%20reports/EXPLORER/EXPLORER/Cornerstone%20Academy/Cornerstone_Academy_Tech_Report_Final.pdf, page 21

DOC-002: SID Fluid Power: If a company is using fluid power, fluid power diagrams must be provided. The first figure must document the components on the surface. The second figure must document the components located onboard the ROV.





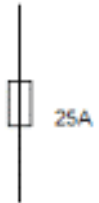

DOC-003: Independent Sensor Devices: If a company is utilizing an independent sensor device that will be installed and released by the ROV, a SID must be included for this device. This diagram must be completed to the specifications listed in DOC-001.

DOC-004: All required documentation sent to the MATE Center MUST be in searchable PDF format (see <https://fd4686477cb19f983f54-68abf00cbc1a2cc111562c013cb867db.ssl.cf1.rackcdn.com/SearchablePDFs.pdf> for information about creating searchable PDFs.

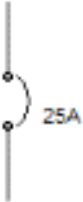
DOC-005: All symbols used in documentation must be in ANSI, NEMA or IEC format.

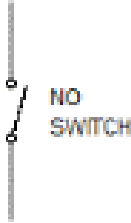
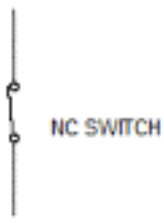
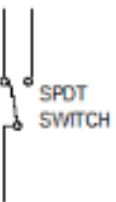
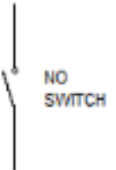
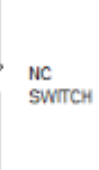
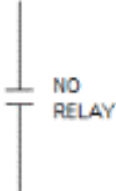
DOC-006: The following ANSI and IEC symbols are all acceptable for MATE required documentation.

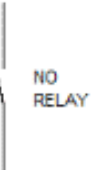
Item	ANSI	IEC
FUSE		

CIRCUIT BREAKER		
SWITCH	  	 
RELAY CONTACT	 	 

2.0 SAFETY

Safety is the competition's primary concern and guiding principle. Any system that is deemed unsafe by competition officials will not be allowed to compete. If a safety concern is identified during the initial inspection, companies are permitted to modify their system and have it re-inspected. Companies are permitted to have their vehicle re-inspected twice. If a company fails to pass its third and final safety inspection, it is disqualified from the underwater competition portion of the event. There are NO APPEALS once an ROV has been disqualified.

Examples of safety violations from previous ROV competitions include:

- The electrical SID included in the technical documentation did not show a main fuse or circuit breaker.
- The ROV used pneumatics, but the technical documentation did not include a pneumatics diagram.
- The ROV used pneumatics, but the company had not passed the fluid power quiz.

2.1 Job Site Safety Analysis

Each member of the company is encouraged to read [Oceaneering Americas Region HSE Employee Handbook](#), with emphasis placed on the following chapters.

Chapter 1 - Housekeeping

Chapter 9 - Hand Safety

Chapter 11 - Lifting and back safety

Chapter 12 - PPE

2017 EXPLORER Class

Chapter 17 - Tool Safety
Chapter 24 Electrical Safety
Chapter 29 - Employee Observation Program
Chapter 33 - JSEA
Chapter 37 - Working at Other sights

Job Site Safety Analysis (JSAs)

For companies advancing to the international competition, up to 10 additional points can be earned by creating a JSA and submitting it along with (but as a separate document from) the [Technical Documentation](#). The JSA should be submitted as a pdf and use the following naming convention: School or organization name_company name_JSA_2017.pdf. They must be submitted via the form located here –

<https://www.emailmeform.com/builder/form/IFKbdLUvk3e1V>

A **JSA** describes job tasks in step-by-step fashion, identifies associated hazards at each step, and outlines proper hazard controls that minimize the risk of injury or illness to the individual(s) performing that task. JSAs are used extensively by the offshore industry.

For more information and examples, companies can visit the following web sites:

- <http://ehs.berkeley.edu/how-do-i-write-and-update-job-safety-analysis-jsa>
- www.safetyworksmaine.com/safe_workplace/safety_management/hazard_analysis.html

POTENTIAL HAZARDS

DESCRIBE JOB STEP <small>(List the natural steps of the job. Do not make the steps too broad or too fine)</small>	POTENTIAL HAZARDS <small>(What are the potential hazards identified at this part of the job steps)</small>	RECOMMEND RISK CONTROL MEASURES <small>(describe how the identified hazards can be eliminated or reduced)</small>	RESPONSIBLE PERSON (S) <small>(Implementing control)</small>	INITIAL <small>(Of the responsible person/s)</small>
Toolbox Talk	Miscommunication	<p>ANYONE can call ALL STOP at any point if an unsafe condition /act is perceived/observed.</p> <p>Cell phone use is PROHIBITED in test area while testing!</p> <p>Ensure all participants are aware of procedures and roles within the procedure and sign JSEA acknowledging thusly.</p> <p>Ensure that all participants are wearing correct PPE (safety glasses, safety shoes, gloves, and hard hats if crane ops are being performed)</p> <p>Ensure participants/witnesses are wearing adequate clothing for weather conditions and to take breaks whenever necessary.</p>		
Hydraulic Function Testing	<p>Stored/Trapped Energy: Up to 12,000 PSI</p> <p>Environmental Discharge</p> <p>Tubing/Hose Failure</p> <p>Line of Fire</p>	<p>Ensure all functions have pressure/flow reduced to 0 PSI when not being actively function tested.</p> <p>Ensure each circuit is setup correctly before increasing pressure.</p> <p>Ensure Vent hoses are properly connected to fluid containment reservoir.</p> <p>Ensure all hoses are whip checked before coming up on pressure.</p> <p>Ensure valves and actuators are in proper configuration before testing.</p> <p>Ensure relief valves are set to relieve at the proper setting.</p>		

Example JSA task items courtesy of Oceaneering International

2.2 Safety Pre-inspection

Companies MUST submit the following documentation to the MATE Center along with (but as separate documents from) their technical documentation by May 26th, 2017:

- Company Spec Sheet
- SID(s) Note: SID(s) are also required to be included within the technical documentation.
- Company Safety Review

All documents must be submitted as pdfs with a maximum file size of 2MB. All documents should use the following naming convention: School or organization name_company name_Spec Sheet_2017.pdf; School or organization name_company name_SID_2017.pdf; and School or organization name_company name_Company Safety Review_2017.pdf. They must be submitted via the form located here – <https://www.emailmeform.com/builder/form/IFKbdLUvk3e1V>

If multiple SIDs / Fluid IDs are submitted, give each a number or additional description.

NEW in 2017!!! Company Safety Review

All EXPLORER companies advancing to the international competition must submit a company safety review explaining and showing how they met the following specifications:

- Anderson Powerpole connectors are the main point of connection to the MATE supply (ELEC-010E).
- A properly sized fuse or breaker is within 30 cm of the main point of connection. The company must use a ruler to show this distance (ELEC-008E).
- Fuse calculations (ELEC-008E).
- The inside of the control box is does not have exposed wiring (ELEC-017E), the control box is neatly laid out with attention to workmanship (ELEC-022E), a separation and identification of 120VAC wiring from DC and control voltages (ELEC-023E). If AC wiring is not used in the control box, include a statement saying no AC is used.
- All wires entering and leaving the control system have proper strain relief (ELEC-024E).
- If hydraulics / pneumatics are used that the company has passed the Fluid Power Quiz (FLUID-014). If fluid power is not used on the vehicle, include a statement saying no fluid power is used.
- Hydraulic / pneumatic systems include a pressure release valve and regulator in the system (FLUID-007, FLUID-011), and that any pressurized cylinder, pressure storage device meets the MATE specifications (FLUID-012, FLUID-013).
- Any watertight housing on the vehicle can withstand pressure at 5 meters (MECH-001).
- All propellers are shrouded (MECH-006).
- The ROV has no sharp edges or elements of the ROV that could cause damage (MECH-006, ELEC-017R).

The **Company Safety Review** should include an explanation of how they system meets the safety specifications and photographs of the relevant system for review by the MATE Center staff.

Companies must submit their Company Safety Review to the MATE Center by May 26th, 2017, along with (but as a separate document from) their technical documentation. Companies that do not submit a Company Safety Review by the required date will be DISQUALIFIED from advancing to the international competition.

International competition safety inspectors will review companies' documentation for an **initial safety inspection** worth 10 points. Safety inspectors will also compile a list of the safety violations and publish them to the competition web site. This is not done to "call out" or embarrass companies in any way. It is to emphasize the fact that EVERYONE is responsible and accountable for ensuring a safe, successful event. It also allows the company to correct the safety violations before arriving at the international competition.

Initial Safety Inspection Penalty points

Penalty points will be subtracted from the safety inspection points (see below) if:

- Companies do NOT submit the documentation by May 26th, 2017.
- The SID does not show a fuse or a fuse that does not use an ANSI, NEMA or IEC symbol.
- Fuse calculations are not shown on the SID.
- The vehicle uses fluid power, but a fluid power diagram is not included.
- The technical documentation is not submitted in a searchable PDF format.
- The technical documentation file is over 8MB in size.
- The company spec sheet, SIDs and company safety review are over 2 MB in size.

2.3 Safety Inspection

Companies must complete their safety inspection before their vehicles enter the water.

On the first day of the international competition, companies will be assigned to a safety inspection room where they will undergo their safety inspection. The inspector(s) will reference the list of violations from the initial safety inspection as he/she conducts the safety inspection of the vehicle using the safety inspection rubric.

2.4 Safety inspection protocol

1. Before entering the water for practice or a product demonstration run, the ROV system **must** go through a safety inspection. Once the company successfully passes inspection, they will turn in their safety inspection sheet and be presented with a Green PASSED Flag. Companies must present the Green PASSED Flag to the pool practice/product demonstration coordinator before their vehicles are permitted to enter the water. Each company's flag will be uniquely identified with company number on the flag.
2. Competition staff will conduct a safety inspection of the vehicle using the [safety inspection rubric](#).
3. If the safety inspector(s) identify a safety violation, companies will have the opportunity to address it. The pool practice or product demonstration run schedule will NOT change to allow companies more time.
4. If during the second safety review the
 - a. violation has not been properly addressed or
 - b. another violation is revealedcompanies will have ONE additional opportunity to address the issue.
5. If during the third safety review a violation still exists, companies will not be permitted to participate in the underwater product demonstration component of the competition. However, companies can still participate in the engineering and communication (technical documentation, product presentation, and marketing display) component.
6. Reminder: All companies must present the Green PASSED Flag to the pool practice or product demonstration judge before placing their vehicles in the water. In addition, product demonstration station judges and competition officials can pause or stop a product demonstration run at any time if they feel that there is a potential safety concern.

New in 2017!!! Companies do not need to present their Green PASSED Flag to the judges during their product presentation. Companies that have their product presentations scheduled for the first day do not require an early safety inspection in order to participant in their presentation.

2.5 Safety Inspection Points

The safety inspection is worth 30 points. Each time a company fails its safety inspection it loses 10 points. After a company fails its second inspection, it must meet with the chief safety inspector to discuss a plan of action prior to returning to its workstation. THREE STRIKES and a company

- a. receives 0 points for the safety inspection and
- b. is disqualified from the underwater product demonstration component.

3.0 SPECIFICATIONS

The ROV system (or “system”) must meet the following requirements:

3.1 Operational

3.1.1 Multiple Vehicles

OPER-001: MULTIPLE VEHICLES ARE NOT PERMITTED. Companies are required to design and build ONE ROV that can complete the necessary product demonstration tasks. “Floating eyeballs” or other vehicles that are not hard connected to the frame of the main vehicle are NOT permitted. Cameras designed to provide a “birds-eye view” are permitted provided that these cameras are hard connected to the frame of the main vehicle. “Hard connection” does not include the wiring between the camera and the ROV.

3.1.2 Environmental

OPER-002: The ROV system must be able to function in fresh, chlorinated water with temperatures between 15°C and 30°C. The water should be considered conductive of electrical currents.

OPER-003: The pool will not be covered or purposefully darkened in any way, although the specific product demonstration tasks may require that your ROV operates in low-light.

OPER-004: No water currents will be intentionally created. However, depending on the venue, pressurized pool filtration system outlets may cause unexpected currents.

OPER-005: The pool venue at the international competition has a smooth bottom.

Note: EXPLORER companies attending regional competitions should note that regionals may be held in pool venues with different environmental conditions than those listed here. If you are unfamiliar with the regional pool, contact the [regional coordinator](#) in your area.

3.1.3 Service Requirement

OPER-006: Companies shall provide a crew of at least 3 but not more than 6 people on the pool deck to operate the ROV System. Companies can send a larger crew complement, but no more than six can be on the deck at any time. More information about this “product demonstration team” is provided in the [COMPETITION RULES](#).

3.1.4 Calibration Requirement

OPER-007: All measurement devices shall be calibrated according to manufacturer recommended calibration procedure and performed by company members only. Company mentors or advisors are not permitted to perform calibration procedures. More information about mentor restrictions is provided in the [COMPETITION RULES](#).

3.1.5 Maintenance

OPER-008: System maintenance during field operations shall be conducted by ROV personnel at their workstations. Work of any kind must not be done by company mentors or advisors. All maintenance parts and equipment necessary to meet the operation requirements shall be provided by the company. More information about these regulations is provided in the [COMPETITION RULES](#).

3.2 Mechanical/Physical

This section of the document provides specifications for the mechanical properties of the ROV system.

3.2.1 Materials

MECH-001: At the international competition, any electronics housings on the ROV shall be capable of operating to depths of 5 meters.

3.2.2 Size and weight

MECH-002: ROVs are limited to a maximum diameter of 85 cm. Vehicles above this size will not be allowed to compete. ROVs are limited to a maximum weight, in air, of 25 kg. Vehicles over this weight will not be allowed to compete. Companies must be able to personally transport the vehicle and associated equipment to the product demonstration station and to the product presentation room. ROV systems must be capable of being safely hand launched. Additional points will be given to smaller, lighter vehicles (see [Size and Weight Restrictions](#)).

3.2.3 Tether Length

MECH-003E: At the international competition, ROVs must be capable of operating in a maximum pool depth of 4 meters (13 feet). All underwater product demonstrations will take place within 8 meters from the side of the pool. The product demonstration station will be no more than 3 meters from the side of the pool. Tether length should be calculated accordingly. EXPLORER companies attending regional competitions should note that regionals may be held in pool venues with different maximum depths than those listed here. If you are unfamiliar with the regional pool, contact the [regional coordinator](#) in your area.

3.2.4 Vehicle Deployment and Recovery

MECH-004: The ROV system must be launched and recovered manually; no powered winches or portable cranes can be used. Hand-powered lifts and levers may be used to launch and recover the vehicle. The vehicle and any associated equipment must not damage any part of the pool or pool deck.

MECH-005: Any hand-powered lift or levers that are used as a LARS must be detailed in the technical documentation and must be part of the safety inspection procedure. Any LARS equipment that is deemed as unsafe at the safety inspection will not be allowed. Ladders, tripods, or other bracing equipment are not permitted as part of a LARS.

3.2.5 Propellers

MECH-006: **Propellers must be shrouded.** ROVs that have propellers exposed will not pass the safety inspection and will not be allowed to compete. A shroud must completely encircle the propeller and extend at least 2 mm in front of and behind the propeller.

3.3 Electrical

ELEC-001: All power provided to the ROV system through an external connection for any purpose during the competition must be obtained from the MATE competition power supply. This includes dedicated lines for cameras, manipulators, and any other devices. This is a singular point of connection; all power to the ROV must pass through the MATE-provided fuse AND the single in-line fuse or circuit breaker as specified in this section.

The exception to this rule is an independent sensor. If a MATE Center task allows an independent sensor, that sensor may be powered by other means. Sensors that are independent of the vehicle must be powered from the surface; no onboard batteries of any type are allowed. Companies may use USB to connect their sensor to a computer. Companies may also use surface battery packs (limited to 12 volts maximum) or the MATE supply to provide power for their water flow rate sensor. The independent sensor may only contain the intended sensor; thrusters, cameras or other systems **MAY NOT** be attached to the independent sensor.

Companies that use an independent sensor must provide a 3 amp (or less) fast blow fuse on the positive side of their connection. If companies are using the 48 volt MATE supply to power their sensor, both the ROV and the sensor must run through the single fuse (or circuit breaker) before splitting off to the 3 amp sensor fuse. Companies using USB only to power an independent sensor may utilize the built-in current limiting of USB and do not need to add an additional fuse.

ELEC-002E: The ROV system must be capable of operating off the power provided by a MATE supply with a nominal voltage of 48 VDC. This voltage may be as high as 56 volts. Power supplies will be a fixed output voltage and will not be “turned down” to accommodate other than the specified voltage for the class. All references to 48 VDC in this document are the nominal voltage of 48 VDC which must be within the ranges specified in this paragraph.

ELEC-003E: The ROV system must deliver the supply voltage to the ROV as provided and without modification. No conversion of this voltage is allowed prior to it arriving at the ROV system bus. Methods on the surface such as DC/DC converters, voltage drop resistors, and Pulse Width Modulation (PWM) are not allowed to be used between the ROV and the power source. ESCs and H-bridges are not allowed on the surface. Power supplies and conversion devices are not allowed on the surface if they operate the ROV.

MATE strongly urges companies to refrain from sending reduced voltage signals from the ROV back up the tether to power devices on the surface. This is not done by ROVs in the field and therefore discouraged by the MATE Center.

ELEC-004E: ROV systems may use any voltage desired up to 48 Volts, but any conversion to a lower voltage must be made on board the ROV. Companies will not be permitted to operate an ROV that reduces the voltage on the shore-side/top-side end of the ROV tether.

ELEC-005E: Voltage may not be increased above the nominal 48 volts anywhere in the ROV system.

ELEC-006E: Sonar or other systems that may have DC/DC conversion resulting in voltages above 48V nominal are not permitted.

ELEC-007E: Voltages in excess of the class parameters set forth in this specification are not allowed on the ROV system at any time other than any inductive spikes that are caused by the switching on/off of motors, solenoids and other inductive devices. Companies should design their systems to handle these voltage spikes but will not be penalized for the presence of these in a system. For additional information on this, companies can research back electromotive forces (back EMF), collapsing magnetic motor fields, and transient suppression.

3.3.1 Current

NEW in 2017!!!

ELEC-008R: ROVs will be limited to 30 amps.

The ROV system must have a fuse (or circuit breaker) that is calculated based upon the maximum current draw of the ROV. This overcurrent protection must be calculated as follows: ROV Overcurrent Protection = ROV Full Load Current * 150%. The overcurrent protection value may be rounded up to the next standard fuse. Companies must use a fuse that is rated for overcurrent protection. In no case can that value exceed the 30A maximum. The fuse or circuit breaker must be installed in the positive power supply line within 30 cm of the power supply attachment point. The fuse may be a slow blow type. The SID and other electrical diagrams must show the fuse or circuit breaker and include the amperage of the overcurrent protection. In addition, the SID must show the calculations used in determining the overcurrent protection value. SIDs without these

calculations shown will have 5 points deducted from the initial safety inspection sheet. Also, SIDS without fuse calculations will not pass safety inspection.

ROV Overcurrent Protection Example:

Eight motors, 2.7 amps each = 21.6 amps.

Two cameras = 0.25 amps.

Two servo motors = 0.8 amps

One laser = 0.002 amps.

Total Amps: **22.87 amps** X 150% = **33.98 amps**.

ROV uses a **30 amp** fuse.

All information on overcurrent protection should be included on the SID. Show your work.

The MATE power supply will be protected by a 30 amp fuse; however, the ROV system must also have its own calculated fuse (or circuit breaker).

NOTE: Companies using circuit breakers for their overcurrent protection should ensure that the method used to house the circuit breaker is safe and not so large that it will cause undue strain on the power connector. In the past, oversized and heavy circuit breaker enclosures have caused companies to replace their circuit breaker box with a simple fuse. Anything deemed by the safety inspectors as being too heavy, a hazard, or not done in a workmanship manner will be rejected at the safety inspection.

ELEC-009R: ROV systems are allowed one replacement fuse during the product demonstration. In the event that the ROV system blows the second fuse during the demonstration, the demonstration will be over and no additional points will be earned. Companies should have adequate replacement fuses on hand, MATE will not provide replacements. Standard sizes for fuses and fixed trip circuit breakers are 15, 20, 25 and 30 amps. Additional standard fuse sizes are 1, 3, 6 and 10 amps.

3.3.2 Power Connections

ELEC-010E: Power supply connections will be Anderson Power Connectors. Companies' ROV system power wires must have proper connectors to obtain power. The Anderson Power Connectors must be connected to the ROV power wires securely; use of proper (hydraulic) tooling is suggested. Hand crimp tools do not have the force necessary to ensure proper and safe connections. MATE will not provide companies with connectors or adapters at the 2016 International Competition.

<http://www.andersonpower.com/products/multipole-sbs.html>

Housing: Anderson SBS50BLU-BK

Pins: The proper pin for your tether conductors

12 or 10 AWG: Anderson 1339G3-BK

8 AWG: Anderson 1339G5-BK

6 AWG: Anderson 1339G2-BK

New in 2017!!!

MATE strongly discourages the use of Anderson Powerpole “knock-offs”. These connectors do not meet electrical specifications and have the potential to melt under load. Companies unable to locate a source of genuine Anderson Powerpole connectors can purchase Anderson Powerpoles from the SeaMATE Store or should contact their regional coordinator.

ELEC-011E: The power supply may be located up to 1 meter from the station table and may be located on either side of the table. MATE recommends a power cable long enough to reach the power supply up to 3 meters from your control system.

3.3.3 Tether Voltages

The signals in the tether must meet the following specifications:

ELEC-012E: Low voltage, low current AC or DC control or sensor signals. Low voltage is defined as a voltage equal to or less than the maximum supply voltage per class specification. Low current is defined as being less than 500mA.

ELEC-013E: DC main-supply at a nominal voltage of 48VDC as provided by the MATE power supply.

ELEC-014E: Ethernet, USB, or other ANSI or IEC accepted serial protocol signals.

All cameras, including USB cameras, must be powered by the MATE supply. Powering a USB camera from the MATE supply can be accomplished by using a USB repeater / extender that has a separate power input at the far (ROV) end. The ROV must convert the 48V to 12V or 5V as needed to power the device from the MATE 48 volt supply. This conversion must be done on the ROV. USB cameras plugged directly into laptops are not allowed.

ELEC-015E: NTSC or PAL Video signals

ELEC-016E: Fiber optic cabling of any type may be used.

3.3.4 Exposed connections and disposable motors

ELEC-017E: ROVs with electrical connections that are exposed to water and not sealed are not permitted to enter the water. Taping a connection with electrical tape only does not constitute a sealed connection. The process of sealing electrical connections must include methodologies such as, but not limited to, Silicone RTV, hot melt glue, epoxy, self-vulcanizing tape, and enclosure of the connections in a housing.

ELEC-018E: “Disposable motors” are not permitted; these are exposed motors with no waterproofing.

3.4 Onboard Electrical Power

ELEC-019E: Onboard electrical power (i.e., power not provided by the tether): Onboard battery powered devices are NOT allowed under any circumstance.

NOTE: *Water leaking into a closed battery container can result in the generation of hydrogen gas. This gas can build up inside a pressure housing and create an unsafe situation. For this reason, onboard batteries are NOT allowed under any circumstance. Any device that needs power must obtain that power directly from the ROV tether. For devices that operate at a voltage other than the tether voltage, an onboard ROV converter may be included. The converter must be sealed and not exposed to water. This rule includes commercial “watertight” battery containers; no battery of any type is permitted on any competition vehicle.*

3.5 Power Shutdown

ELEC-020E: For safety purposes, any ROV system that is disconnected from the surface supply must stop functioning in less than 5 seconds. This applies to electrical, pneumatic, and hydraulic power sources. Any filters, capacitors or accumulators must be sized accordingly to meet this specification.

3.6 Fluid Power

3.6.1 Documentation

FLUID-001: Documentation required must include a fluid power diagram using industry standard symbols, showing all items, regulators, and control valves.

3.6.2 Hydraulic Power

FLUID-002: Hydraulic fluid: Water or biodegradable food-grade fluid, only.

FLUID-003: If a biodegradable food-grade fluid is used, a Material Safety Data Sheet (MSDS) must be provided at the safety inspection. The MSDS must show the type of fluid used and its compatibility with the Biodegradable Food-Grade specification. Companies using water do not need to provide an MSDS.

FLUID-004: The following fluids are approved for use in hydraulic systems:

- a. Water
- b. Biodegradable Food-Grade Hydraulic Oil ISO Grade 32/46, SAE Grade 20, McMaster-Carr part# 3499K22

All other bio-degradable food-grade fluids must be approved by the [Competition Technical Manager \(mgardner@marinetech.org\)](mailto:mgardner@marinetech.org) by March 3, 2017.

FLUID-005: Maximum Hydraulic pressure allowed: 10.33 bars (150 psig).

FLUID-006: Hydraulic system: All lines, fittings, and hydraulic devices must be rated for a minimum pressure of two (2) times the maximum supply pressure.

FLUID-007: Hydraulic pumps must be part of the safety inspection.

1. They must have a pressure relief valve with a maximum setting of 300 psig or less installed before the pressure regulator.
2. The pump must have a regulator in place and set to 150 psig or less.
3. Pumps with any sign of external rust or deterioration will not be accepted.
5. All wiring must be secure.
6. All guards must be in place.
8. Hydraulic pumps may run off of the 15A 115VAC outlet provided for command and control as long as the hydraulic fluid is not used to propel the ROV. The hydraulic fluid is to be used for grippers and actuators only.

3.6.3 Pneumatic Power

FLUID-008: Pneumatic fluid: Compressed air or inert gas only

FLUID-009: Maximum pressure allowed: 2.75 bars (40 psig)

FLUID-010: Pneumatic system: All lines, fittings, and pneumatic devices must be rated for a minimum pressure of two and a half (2.5) times the maximum supply pressure. For example, if an 83 bar (1200 psig) tank is regulated to 2 bars (30 psig), then all system components must have a minimum rating of 5.17 bars (75 psig).

FLUID-011: Air compressors must be part of the safety inspection. .

1. They must have a pressure relief valve installed before the pressure regulator.
2. The compressor must have a regulator in place and set to 40 psig or less.
3. Compressors with any sign of external rust will not be accepted.
4. The tank drain valve must open.
5. If more than 5 ml of water exits upon opening the drain valve, the compressor will not be accepted.
6. All wiring must be secure.
7. All guards must be in place.
8. Air compressors may run off of the 15A 115VAC outlet provided for command and control as long as the air is not used for motor thrust. The air is to be used for buoyancy/ballast, grippers and actuators only.

3.6.4 Pressurized Cylinders

FLUID-012: Pressurized cylinders may be used, but must remain above the water surface and meet the following specifications:

- a. Approved by US DOT (Department of Transportation) or TC (Transport Canada). For regional competitions taking place outside of the US, check with your [regional coordinator](#) for approval.
- b. Have a current official inspection/test sticker and/or stamp.
- c. Stamped with the maximum allowable pressure.
- d. Contain a pressure relief safety device.
- e. May be filled up to the maximum allowable pressure of the cylinder.

- f. Must be regulated at its output to a maximum of 2.75 bar (40 psig).
- g. Must have an easily accessible shut-off valve that is clearly marked with instructions.
- h. May only be stationed on the surface, not on the ROV.
- i. Must be secured in a safe manner such that they will not fall or roll around. If the judges feel that a cylinder is unsafe, they have the discretion to prevent its use.
- j. SCUBA tanks are permitted. They must meet all the above specifications and have a current visual inspection sticker, or “fill permit” visible.

3.6.5 Pressure Storage Devices (Pressure Accumulators)

FLUID-013: Pressure storage devices are allowed on the ROV if they do not exceed 1.25L in total storage and do not store pressure higher than the allowed pressure for air or hydraulics. It is recognized that a company may not be able to purchase a pressure accumulator that has the proper rating and fits in the space needed. In that case, the company must show that their designed accumulator is capable of withstanding the specified pressures without rupture.

3.6.6 Fluid Power Quiz

FLUID-014: EXPLORER class companies planning to use hydraulics and/or pneumatics (i.e., fluid power) are required to take and pass an online quiz with a score of 100%.

NOTE: The quiz was developed by MATE Center technical support staff and competition judges and is designed to ensure that companies understand basic information on these topics and can apply that knowledge to safe practices. The intention is not to add yet another “requirement,” but rather to provide a safe and successful learning experience and competition environment.

*The quiz should be completed by the STUDENT company members. Each member of the company does NOT have to take the quiz; students can work together and make it a group effort. **ONLY ONE TEST PER COMPANY.** The company’s instructor or mentor can provide guidance and advice, but the questions should be answered by the students participating on the company. The quiz will be scored and the results provided instantaneously. **A score of 100% is considered a passing grade. Companies can take the quiz as many as 5 times to achieve this score.***

***The quiz must be completed with a passing grade by March 3rd, 2017.** Companies failing to complete this quiz within the given time frame will NOT be permitted to use fluid power during their competition event.*

FEE TO TAKE THE FLUID POWER QUIZ! The fee to take the fluid power quiz is \$15 for five attempts (no discounts for fewer attempts) and must be paid for at the time of registration. Companies will see an option to purchase the fluid power quiz when they register. Within five business days of receipt of payment, companies will receive a link, username, and password to take the quiz.

Note: The login information will be sent to the email address used when creating the team/company within the Active registration system – it must be an accurate and current email or you will not receive quiz access.

The following are sources of information on hydraulics and pneumatics. This is not intended to be an exhaustive list, but rather a starting point to encourage Companies to seek out additional information and resources.

- **Underwater Robotics: Science, Design & Fabrication**, published by the MATE Center (see www.marinetech.org/underwater_robotics)
- <http://www.fxsupply.com/pneumatics/psafety.html>
- <http://mining.state.co.us/safety/downloads/ppoint/HydraulicPressureIntensification.ppt>
- National Fluid Power Association – <http://www.nfpa.com/education/mini-book.asp>
- Parker Hannifin Corporation – <http://www.parker.com/> (look for technical literature links)

3.7 Control Systems

ELEC-021E: EXPLORER class ROVs are expected to utilize computer (or electronic) based control methodologies and H-Bridge or BLDC controllers for the thrusters. Systems using surface switch box controllers will not be permitted.

ELEC-022E: Surface control stations must be built in a neat and workmanship like manner. Loose components and unsecured wires will not pass safety inspection.

ELEC-023E: Surface control stations by nature combine 120VAC and 48VDC wiring. The surface control stations must be wired in a manner such that the 120VAC wiring is physically separated from the DC wiring, the 120VAC wiring is clearly identified from the DC and control voltages, and every conductor is insulated in a manner that no conductor is exposed. Identification can be through signage and/or wire color schemes. All 120VAC wiring colors must use ANSI, NEMA or IEC standard wiring colors appropriate to each voltage. There must be a sign inside the surface control station indicating which wiring standard is being utilized. Companies that do not have adequate separation of AC wires and components and DC wires and components will NOT pass safety inspection. It is recommended that separation be designed into the control system to keep power systems separate. Wiring should be clear, neat and easy to follow by inspectors. Wiring “Rat’s nests” or “spaghetti wiring” will not pass safety inspection.

ELEC-024E: All wires entering and leaving the surface control station must have adequate strain relief and wire abrasion protection as the wires pass through the enclosure. Tape, zip ties, hot melt glue, string and similar methods are not acceptable.

ELEC-025E: Any connectors utilized in the surface control station and elsewhere in the ROV system must be properly type rated for their application. AC rated connectors must not be used for DC. The connectors must also be rated at or above the voltage and current used in their application.

3.8 Command, Control, & Communications (C3)

3.8.1 Power Provided

CCC-001: Surface power: MATE will provide one GFI-protected outlet with a nominal 115 Volts AC (60 Hertz) and 15 amps maximum. This outlet is intended to provide power for pumps and other surface support equipment (e.g. video monitors & control boxes). This AC power source CANNOT be used to directly or indirectly power the vehicle.

CCC-002: If hydraulic or pneumatic power is used for vehicle thrust, the power for the pump must come from the MATE supplied DC power supply.

CCC-003: In addition to electric pumps, hydraulic, and pneumatic systems can be powered by manual pumps (e.g. bicycle tire pump) or supplied from a pre-pressurized cylinder. Companies that are only using manual pumps do not need to pass the fluid power exam.

3.8.2 Displays

CCC-004E: Companies are not limited to the number of display screens used for video feeds or ROV status information. Display devices may be made up of any combination of TVs, monitors, laptops, and/or computer displays.

CCC-005E: These display devices may be powered by the MATE provided GFI-protected 115-Volt AC (60-cycle) and 15-amp AC power source described in CCC-001, Surface power.

CCC-006E: A company's C3 station may include devices like video recorders. All C3 devices must be able to run on the single AC power outlet provided or on its own internal battery power. Any device plugged into this AC power outlet can only provide C3 functions and cannot provide power to the ROV.

3.9 MATE Provided Equipment

MATE will **NOT** provide video monitors at the product demonstration stations.

3.9.1 Companies Sharing Equipment

Companies may share the following equipment during the competition event: monitors, joysticks, and compressors.

Companies may NOT share the following equipment during the competition event: control systems and payload tools (e.g. grippers, manipulators).

Contact your [regional coordinator](#) to determine if equipment can be shared at your regional event.

Companies that plan to share equipment during the international competition event must notify the [Competition Technical Manager \(mgardner@marinetech.org\)](mailto:mgardner@marinetech.org) at least 4 weeks prior to the event so that this can be considered when creating the schedule. MATE will do its best to accommodate companies sharing equipment.

3.10 Laser Safety Rules

LASR-001: Companies using a laser at the international event must inform the MATE Center and provide the **laser specifications by March 3rd, 2017**. Information and laser specifications should be sent to the [Competition Technical Manager \(mgardner@marinetech.org\)](mailto:mgardner@marinetech.org). Specifications will be forwarded to the MATE Center safety inspection team for evaluation. Once the laser specifications are reviewed, a notification will be sent to the company. If the laser is being used at an EXPLORER regional event or pool practice, notification will also be sent to the regional competition coordinator.

LASR-002: All lasers must operate in the visible range at either the 630-680 nm (red) or near the 532 nm (green) wavelength. All lasers must fall into the Class I, Class II, or Class IIIa category. Red lasers must operate at 5mW or less. Green lasers must operate at 1mW or less.

LASR-003: Companies should include detailed specifications of their laser in their technical documentation as well as have that information ready and available during their safety inspection and product presentations.

LASR-004: Lasers must have an on/off switch. This switch must be on the surface controller.

LASR-005: All lasers must be powered by the MATE surface power supply. Batteries, including batteries for powering lasers, are not permitted on the vehicle.

LASR-006: Companies using lasers cannot increase the voltage or the current to increase the power of their lasers. Lasers must use the voltage and current set in their specifications.

LASR-007: When out of the water, the laser should have a shield or enclosed beam stop attachment within 30 cm of the laser. This means that the laser beam should not travel more than 30 cm before reaching the shield. This is a requirement at all times when the laser is out of the water. The shield does not need to be attached to the ROV while it is in the water. The shield must be painted with FLAT BLACK paint.

LASR-008: At no time should the laser be focused or deviate from a collimated beam.

LASR-009: When testing the laser at a workstation, companies must display a sign telling others that a laser is being operated.

LASR-010: Operators working with the laser while the ROV is out of the water should wear appropriate laser safety glasses at all times. This requirement is for all laser types. Search online to find laser safety glasses appropriate for the wavelength being used.

PART 4: COMPETITION RULES

GENERAL

- All members of the company and their supporters must follow the safety regulations of the ROV competition, pool facility, and event venue.
- All company members and their supporters are expected to conduct themselves in a professional and responsible manner during the competition. Disrespectful behavior towards the judges, officials, pool staff, audience, or other companies will lead to penalty points or disqualification.
- Sabotaging, stealing, or pilfering equipment of other companies will lead to disqualification. Companies found cheating will also be disqualified.
- The MATE ROV competition is, at its core, designed to be an educational and inspirational event for **STUDENTS**. It is designed to challenge them to apply the physics, math, electronics, and engineering skills they are learning in the classroom to solving practical problems from the marine workplace. (See the [MATE Competition Philosophy](#).)

It is expected that all “adults” (non-students; e.g. teachers, mentors, parents) involved in the competition limit their input to educational and inspirational roles. Actual construction of the ROV (particularly in the complex electrical and software areas) must be completed by the students. Adults should teach and advise students about design, electronics, software, and construction, but not complete the work for the students. Throughout the process adults are encouraged to focus on benefits to the students from the process and not simply winning. If it becomes apparent that adults exercised more than an advisory role, judges reserve the right to deduct points or, in extreme cases, disqualify companies from the competition.

While at any MATE ROV competition (international and regional), **ALL** work done on the vehicle must be conducted by company members. Teachers, mentors, parents, and non-competing students are not permitted to work on the ROVs. They may provide advisory input, but they may not work on the ROV directly. This includes writing or editing software code. All mechanical electrical and software modifications and/or repairs to the ROV must be completed by students.

- With learning at its core, the MATE competition encourages students to utilize and build upon their skill sets to find creative solutions to designing and building their ROV. As they move through the process of analyzing their designs and identifying building materials, students may decide to either build a component from “scratch” or purchase it from a commercial vendor. While original solutions are encouraged, the use of commercial components is acceptable, provided 1) that the components adhere to the design and building as well as safety specifications for the particular competition class and 2) more importantly, that the students can provide a reasonable, logical explanation for buying versus building.

The competition scoring rubrics are designed to reflect this; points are awarded based on students’ abilities to explain and justify how all of the components and systems work together as an integrated ROV, regardless if they purchased them, pulled them from public libraries, or made them themselves.

That said, it should be noted that purchasing and competing with commercial ROVs are not permitted.

Note “commercial vendor” includes the SeaMATE store and other competition programs that sell robotics kits. SeaMATE kits were created to remove barriers to participation for teachers and schools unable to easily 1) find parts and materials and 2) set up accounts with multiple vendors. The kits are part of a larger educational package offered by the MATE Center that includes curriculum materials, videos, and other resources to support and enhance learning. And learning is what students who use SeaMATE (or other) kits will be expected to demonstrate during and through the [ENGINEERING & COMMUNICATION](#) components.

PROCEDURAL

- Companies must compete during their assigned time slots. Your company is **NOT** permitted to switch time slots with another company. Failure to show for your scheduled product demonstration or for your company’s product presentation will result in “no score” for that particular competition category. **No exceptions.** Assigned time slots will be sent out in advance so that any scheduling concerns can be addressed prior to the event.
- Companies must complete their size and weight measurements before each product demonstration run. The size and weight measurements are included as part of the product demonstration score. Companies should be at the size and weigh in at least 30 minutes before their scheduled product demonstration run.
- While there is no limit to the number of students who can compete as part of a company, **the product demonstration team (aka demo team) is limited to six students.** The demo team is defined as the team of students who operate the vehicle and its associated equipment during the product demonstration. Only six students will be allowed to enter the product demonstration

station, launch, pilot, and perform the tasks. Instructors, mentors, and/or non-student members cannot participate as part of the demo team. **Companies may alternate students on the demo team for the two product demonstration attempts.** (All members of the company should participate in the engineering and communication components; see [ENGINEERING & COMMUNICATION](#) for more information.)

- Only the demo team members and judges are allowed at the product demonstration station during the product demonstration, which includes the set-up and demobilization periods. Other members of the company, instructors, mentors, audience members, and observers (press or special invited guests) must remain outside the product demonstration station or in designated viewing areas.
- Instructors, mentors, parents, and “fans” are **NOT** permitted at the safety inspection stations or repair tables. Two warnings will be issued before individuals not heeding this rule will be asked to leave the venue.
- In addition, instructors, mentors, parents, and fans are **NOT** permitted to work on the ROV. Individuals who are seen working on the ROV who are not student company members will be issued a warning. Two warnings will be issued before individuals not heeding this rule will be asked to leave the venue. If companies choose to take their ROVs off the competition grounds for maintenance and repair, they are expected to observe this rule in the interests of the spirit of the competition.
- Video devices may be used to record the underwater activities for entertainment and learning purposes **only**. Video will not be used as an instant replay to review judges’ decisions or to challenge product demonstration timing.
- Product demonstration stations will be roped off and marked. Product demonstration stations will contain 2-3 chairs and one 6-foot table long table for companies to use. This table will be within 3 meters of the pool edge. Product demonstration stations will be set up to prevent the pilot(s) from looking at the ROV in or under the water except through the ROV cameras.
- Companies will compete in one product demonstration that will consist of four tasks. Companies will get TWO attempts at the one product demonstration. The higher of the two scores will be added to the engineering and communication score to determine the total, overall score for the competition.
- The product demonstration time consists of a 5-minute set-up period, a 15-minute performance period, and a 5-minute demobilization period. If the demo team and all of their equipment are not out of the product demonstration station at the end of the 5-minute demobilization period, the company will be **penalized 1 point for each additional minute.**

- Manipulating the tether to free it from underwater obstacles is permitted. Pulling on the tether to speed up the recovery of items or to return your vehicle more quickly to the surface is not permitted and will result in penalty points. Judges will issue one warning if tether pulling occurs. Each future infraction will result in 5 points deducted from the final product demonstration score.
- SCUBA diver assistance will be available at the international competition. If help is required, the company CEO or pilot must ask a station judge and divers for assistance. Each diver assistance will incur a 5 point penalty. The product demonstration clock will not stop if a company is receiving diver assistance.

For EXPLORER class companies attending a regional competition, diver assistance may not be available at the regional competition. Contact the [regional coordinator](#) to determine if diver assistance will be available at the regional competition.

- Pilots can only leave the product demonstration station and move poolside to repair, adjust, or alter a vehicle if the ROV is surfaced and at the side of the pool.
- Companies are not permitted to leave debris in the pool. Any debris must be recovered by the ROV before time has expired or the company will be penalized. Debris is defined as pieces of the ROVs, weights, floats, or other items created by the company. Task props are not considered debris. The product demonstration notes section may cover special items that can be left in the pool after time has expired.
- No demo team member shall enter the water to complete an object recovery. Only arms and hands are allowed into the pool to retrieve an object or to retrieve the vehicle. Companies will be disqualified or penalized depending on the severity of the infraction.
- Communication between demo team members at the pool edge and demo team members piloting the vehicle will be limited. Only tether management issues (e.g. how much tether is out, how much is remaining on the pool deck) can be discussed. Those company members at the pool edge cannot give any directional or product demonstration task information to the pilot. Judges will issue one warning regarding illegal communication. Each future infraction will result in 5 points deducted from the final product demonstration score.
- Communication using cell phones, text messaging, and online social media tools such as Skype, Facebook, Twitter, instant messaging, etc. is NOT permitted during the product demonstration, either between the demo team members at poolside or between any demo team member and anyone outside of the product demonstration station. The ROV and/or the ROV control system is not allowed to broadcast video or other information to anyone outside of the product demonstration area. No exceptions. Companies found broadcasting any data to those outside of the product demonstration area will be disqualified.

- **Product demonstration judges and other competition officials will only communicate with students.** Judges and officials will NOT communicate with mentors, parents, or other non-student members regarding product demonstration information, challenges, or other issues except during pre- and post-competition briefing sessions.

Companies that wish to issue a challenge during the product demonstration run should immediately communicate this challenge to the product demonstration judges. The judges will discuss and attempt to resolve the issue. If a decision cannot be made, the product demonstration judges will consult with the head judges and competition technical manager to resolve the issue.

DESIGN & SAFETY CONSIDERATIONS

- The competition coordinators and host venues stress the importance of safety practices and procedures to all companies. The score sheets will reflect the MATE Center's efforts to encourage and reward companies that demonstrate exceptional safety practices and procedures.
- **ALL ROVS MUST PASS A SAFETY INSPECTION CONDUCTED BY COMPETITION OFFICIALS PRIOR TO ENTERING THE POOL.** These inspections will be conducted topside to ensure that ROV systems meet the design and building specifications and do not pose a risk to the integrity of the event venue. See [VEHICLE DESIGN & BUILDING SPECIFICATIONS](#) for additional information.
- Radio transmitters that operate on a separate battery are permitted. No batteries are permitted to be in or on the water. No exceptions.

Companies should be aware of all the implications of these wireless devices. There is no assurance that an adjacent company's wireless controller will not interfere with your control systems. Adjacent wireless controllers with a battery that has a higher charge than the nearby controller have demonstrated the ability to "hijack" the nearby control signals. In addition, all wireless controllers are susceptible to external sources of electronic interference. Your system may work fine in your home environment, but not in the industrial environment of the competition. MATE will not stop the clock to resolve wireless control issues. Companies deciding to utilize wireless controllers do so at their own risk.

- Keep an eye out for tripping hazards in the product demonstration station and at your company's work station. Make sure power cords are not laying in pools of water on the deck.
- During your product demonstration, be sure to secure any equipment so that it does not fall off the product demonstration station table, damage the deck, or cause injury.

- Loose fitting clothing, jewelry, and long hair could all become safety issues. Consider securing long shirts or baggy pants, removing jewelry, and tying back long hair when working on or operating your ROV.
- ROVs may be constructed out of materials of your company's choice, provided they meet the design and building specifications and safety regulations. Warning labels should be posted on potentially hazardous components of your ROV system.

Close toed shoes are required on the pool deck. Safety glasses are required when working on the vehicle.

- Personal flotation devices (PFDs) will not be required at the international competition. No personal flotation devices will be provided by MATE or the host venue. Regional events may require PFDs. Contact your [regional coordinator](#) to determine if PFDs will be necessary.

PART 5: ENGINEERING & COMMUNICATION

The ability to effectively communicate information about your vehicle and the design and building process is equally as important as how well your vehicle performs. Strong communication skills are an essential part of good business practices. To emphasize this point, the competition requires the following four engineering and communication components:

- Company Spec Sheet
- Technical Documentation (formerly known as the technical report)
- Product Presentation (formerly known as the engineering presentation)
- Marketing Display (formerly known as the poster display)

The Company Spec Sheet, Technical Documentation, and Product Presentation are components where you are communicating with technical audiences, such as potential future clients. (Examples of spec sheets and technical documentation from previous competitions can be found www.marinetech.org/tech-reports. Examples of product presentations can be found on [MATE's Vimeo channel](#).) The Marketing Display should be thought of as part of your marketing (or sales) strategy and aimed at general (including non-technical) audiences.

TIPS FOR EFFECTIVE WRITTEN AND ORAL COMMUNICATION

Communicating ideas about how to solve a problem and evaluating those ideas against competing alternatives is a critical skill for anyone thinking about a career in marine technology. It is a skill that is directly linked to decision making about whether or not to hire (or fund) us and our ability to influence the work that we do.

The key to a successful technical documentation and product presentation is the way that critical thinking and engineering reasoning are communicated. You can think of the process as technical “storytelling.”

Technical storytelling includes the use of text, images, schematics, and data to effectively communicate the “story” of how your company brainstormed and evaluated ideas to come up with your solution (e.g. ROV, payload tools, and operational strategies) to the problem at hand (product demonstration tasks). It also involves organizing content to efficiently present your work and justify why you did what you did.

However, choose details with care. Each detail should help to answer the question “why is what you did the best solution for your company and for this competition?” Describe why a component in the system is critical and how you chose it. Include specifications or dimensions only if they help to explain the “why” and “how” you made choices. Keep in mind that a mechanical drawing with dimensions can replace a lot of text and in many cases do a better job telling details of the story than text.

That said, if something is hard to describe clearly and completely with two to three sentences, consider whether using an image may help. A good technical document balances text and images to provide lots of information concisely, enabling detailed understanding while being quick and easy to read. Remember that your reader is new to your design and needs to understand both what your design is and the process you used to get there. Present text and images in a logical order that helps readers follow your development process and results.

Maintaining a project notebook is a good business practice that will help to capture ideas and document your company’s progress – including your research, designs, trade studies, experiments, data, vehicle specifications, testing, expenditures, and donations. The notebook is also a place to keep track of your company member’s contributions (time, support, etc.).

Along with your notebook, here are some items to consider as you prepare to tell your story:

- What was your company’s “work breakdown structure” (tasks, time, and people)?
- What were the greatest constraints (schedule, budget, equipment, labor, logistics, etc.) on your design process?
- How did the product demonstration tasks and rules influence your design and decisions?
- What systematic process, such as a [tradeoff matrix](#), did you use to evaluate competing design solutions?
- What were the most important design decisions you made and why?
- How did you arrive at your final power budget? What concessions, if any, did you have to make and why?
- How do you calibrate your sensors?

- If your vehicle uses software, where does the code execute? Describe the flow and format of the data.
- Did you have a noteworthy troubleshooting experience? Any problem or procedure that takes more than 20 minutes to figure out is worth understanding and writing down.

Your company should also review the scoring rubrics posted on the MATE web site under [Missions, Specs, and Scoring](#). The rubrics are what the judges will use to evaluate and score your technical documentation, product presentation, and marketing display.

COMPANY SPEC SHEET (ONE PAGE ONLY)

Your company is required to submit a one-page spec sheet along with the Technical Documentation (see below). The goal of the spec sheet is to provide the judges with a “snapshot” of your company. It includes basic information about your company and vehicle.

Companies must submit their spec sheets to the [MATE Center](#) on May 26th, 2017 along with (but as a separate document from) their technical documentation. The file should use the following naming convention: School or organization name_company name_Spec Sheet_2017.pdf and not exceed 2MB.

Company spec sheets will be reviewed by safety inspectors as well as judges.

Companies will receive up to 20 points for submitting a spec sheet that follows the file size and naming specifications and contains all of the following information:

COMPANY SPECS

- **Company and school, club, or community organization name**
- **Home state and/or country**
- **Distance required to travel to the international competition**
- **History of MATE ROV competition participation.** Be sure to specify if your company and/or the members of your company are “new” or “returning.”
- **Company photo and caption indicating members’ names and roles (e.g. CEO, CFO, Design Engineer, Pilot, etc.).** This photo should include all of the members of your company.
- **Range of grade/college levels represented by the members of your company**

ROV SPECS

- **ROV name** if applicable
- **Total cost.** You must include the approximate cost of any donated items.
- **Total student-hours to design and build.** This should include the number of hours that each and every member of the company worked on the vehicle.
- **Safety features**
- **Special features**
- **Photo of the vehicle**

TECHNICAL DOCUMENTATION

Your company is required to submit technical documentation that will be reviewed and evaluated by a panel of working professionals – individuals who represent science, exploration, government, and industry. (These individuals may not be the same judges who evaluate your company's product presentation.) The technical documentation is a means for your company to describe the design, operations, and features of your vehicle. Your clients should gain a good technical understanding of your vehicle and your company's capabilities in addressing your client's needs for an ROV.

Companies must submit their technical documentation to the [MATE Center](#) by May 26th, 2017, which is 4 weeks prior to the competition date.

The technical documentation should be in searchable PDF format (see <https://fd4686477cb19f983f54-68abf00cbc1a2cc111562c013cb867db.ssl.cf1.rackcdn.com/SearchablePDFs.pdf>), use the following naming convention: **School or organization name_company name_technical documentation_2017.pdf**, and not exceed a file size of 8MB.

Technical documentation and company spec sheets must be submitted via the form located here - <https://www.emailmeform.com/builder/form/IFKbdLUvk3e1V>

NOTE: By submitting your technical documentation and company spec sheet, you are giving the MATE Center permission to publish these documents on its web site.

Any changes or additions that you make to your ROV that differ from the information in the technical documentation that you submit should be presented to the judges during your company's product presentation. **NOTE: The judges will not review and rescore revised versions of your technical documentation during the competition.**

Each judge on the panel will award a score (100 points max). Judges' scores and comments will be returned to you shortly after the event.

Requirements and guidelines for the technical documentation include:

- **Length must be 25 pages or less**
- **Font size must be at least 12 points**
- **Recommended font types are Times New Roman, Arial, or Calibri**
- **All measurements must be in SI units (metric), except for PVC pipe diameter (e.g. ½-inch) and other items commonly described or sold using imperial units.**
- **Title page** must include:
 - Your company's name
 - School, club, or community organization's name, city, and state or province, and country.

- **COMPLETE** list of the members of your company and their role (CEO, CFO, Design Engineer, Pilot, etc.). You may also include degree/area of study (or what you plan to major in at college) and expected graduation date.
- Names of your instructor(s) and/or mentor(s).
- **Abstract (*no more than 250 words*)** that is concise and clearly summarizes the project.
- **Table of contents**
- **Photograph(s) of your completed ROV**
Include photo(s) of your completed vehicle and other photos or sketches that capture the vehicle's design features.

You are permitted to make modifications that may change the look of your vehicle between the time you submit your report and the competition; however, in your technical documentation you must include at least one photo(s) of your completed, assembled vehicle, in addition to any photos of individual systems and/or payload.

- **Images**
All photographs, figures, graphs, diagrams, and tables must include captions. Images and text should work together to describe your design and answer readers' questions. Graphs and technical diagrams should include labels for things like data axes, signal paths, and components.
- **Budget**
At the beginning of the project, companies should establish a budget. A budget is different than a project costing sheet (see the next bullet) in that it is a projection of the cost of the project. Companies should create categories and realistically estimate what they think that they will spend in each. If well-thought through, the project costing will align with the budget (i.e., the amount budgeted for a certain category will be the actual amount spent!). **The budget can be included as an appendix.**
- **Project costing**
Project costing is an accounting of your income, donations, and expenditures. Items **must** be listed as one of the following: purchased, re-used, parts donated, or cash donated. For re-used or donated items, report the item's **current market value** and note the source or organization that made the donation. See the project costing sheet located [here](#) for an example.
- **System Interconnection Diagram (SID)**
A SID (also called a block diagram) is a system-level diagram showing how major system (electrical, mechanical, hydraulic/fluid) components are connected. The SID provides readers with a graphical map of the major components and signals needed to understand the design at a high level. It should make clear which parts of the system operate above and below the surface. It should answer the questions "What and where are major parts of the system?" and "What main signals (power, data, electrical, fluid, mechanical) flow between the components?"

The SID will be evaluated on how well it shows the relationship between major system components at an appropriate level of detail (not too much, not too little).

Requirements

- The SID must be drawn using a computer drawing tool (e.g. OpenOffice (free), Inkscape (free) Power Point, Word, Paint, Visio, Omni Graffle, etc.)
- Components and signals (power, control, data) must be labeled
- Industry standard symbols and drawing conventions (ANSI, NEMA, IEC) must be used

Recommendations

- Read the [VEHICLE DESIGN & BUILDING SPECIFICATIONS](#) for more information about the SID

▪ **Block-diagram or flow-chart of software in the ROV (if applicable)**

If your design uses software, it must include a block diagram and flow chart. Like the SID, a software block diagram graphically describes the connections between major software components (functional blocks, i.e., what and where the software parts are). A flow diagram graphically describes the major steps (process) that your software uses to fulfill its role (what the software does). These diagrams should represent the software subsystems at a high level, rather than listing every line of code. They show the judges what software runs where in the system, and demonstrates that you understand how it works.

If you are purchased control system that uses software or use software written outside your company (libraries), you should learn about its operation and describe it in a diagram.

- **Design rationale** presented in a clear and logical manner. This section should comprise the bulk of your report. ***It must focus on the technical aspects of your vehicle and how your ROV was built to perform the specific tasks.*** It must include information about the new vs. used as well as the original vs. commercial components you used and why you made the design choices that you did. See the questions under Product Presentation below for an example of information that you should cover.

- **Safety.** This section must describe the steps that your company has taken to identify and address any safety concerns regarding the design, construction, maintenance, and operation of your vehicle. ***Safety is paramount!*** Your company should reflect that within this section.

- **Designs tested, pitfalls encountered, and lessons learned during the design and building process**

This section should describe the technical challenges that your company faced during the design and building process and the lessons learned and skills gained that allowed you to overcome them. In addition to technical challenges, you may include descriptions of challenges related to project management, working as a team, understanding business practices, etc.

- **Discussion of future improvements**

In this case, the MATE Center is your “client” and has defined both the problem to be resolved and the products and services you need to provide. Consider the needs of potential future clients; these could include research institutions, private companies, and government agencies. A synopsis of ideas for future improvements to designs, processes, and practices is essential to any entrepreneurial organization.

- **Acknowledgements**

Please list your sponsors (companies, organizations (including the MATE Center), professionals from industry, and/or mentors) and the type of support that they provided (funds, building supplies, equipment, site visits to facilities, time, and/or technical expertise). You may also include organizations and/or individuals that provided logistical and/or moral support (e.g. your parents, siblings, or pets). Regional competition companies should also acknowledge regional contest supporters.

- **References**

All reference materials such as books, journal articles, magazines, trade publications, software, web sites, and professional advice that you used for your project must be acknowledged. The references should be noted and numbered in the body of the text then listed here. You should use the Chicago Manual of Style (<http://www.chicagomanualofstyle.org/home.html>) format for the reference list. Web sites like the Citation Machine (<http://www.citationmachine.net/>) make it easy to generate citations in the correct format.

PRODUCT PRESENTATION

During the competition, your company is required to give a 15-minute oral presentation to a panel of working professionals – individuals who represent science, exploration, government, and industry. (These individuals may not be the same judges who evaluate your company’s technical documentation.) Your presentation should describe the engineering behind your vehicle’s design and operation and address any possible safety issues. It should also highlight any design innovations or creative solutions to solving the product demonstration tasks. After the presentation, the judges will take 10-15 minutes to ask the members of your company questions about your ROV. The judges will evaluate both your presentation and responses to their questions.

All student members of your company must participate in this presentation and question and answer (Q&A) period. You are required to have your ROV with you.

NOTE: The product presentation is designed to be a face-to-face interaction where students and representatives from industry become engaged in conversation. MATE will not provide audio visual aids, such as slide projectors, computer projection screens, white boards, etc.; however, you are welcome to distribute handouts to help judges better understand the information that you are presenting. **PowerPoint presentations are NOT permitted.** During the Q&A, all members of the company must be present and prepared to answer.

Instructors, mentors, family members, friends, and members of other companies are permitted to attend. However, we ask that those in attendance be respectful and courteous throughout the presentation and follow-up question and answer period. Be mindful that this presentation may be a stressful time for the students. If the room becomes crowded or the spectators become distracting, it is up to the judges’ discretion to request that some or all spectators leave the presentation. **While they are permitted to attend, instructors and mentors are not allowed to participate.**

Each judge on the panel will award a score (100 points max). Judges' scores and comments will be returned to you shortly after the event.

The judges will pay particular attention to whether or not the vehicle was built by the students from "scratch" or excessively uses complete, off-the-shelf systems. The use of complete, commercially-available systems is highly discouraged (the [COMPETITION RULES](#) includes more information on this topic). Design originality and innovation as well as safeguards to prevent injury or damage to the underwater environment will be noted.

Here are some examples of questions that the judges may ask or observations they may make. **NOTE: These are only examples and may not be the actual questions asked.** Your company must be prepared to answer questions other than those examples listed below.

Structure

- How did you decide on the shape of the vehicle and the materials used to build it?
- What is the design depth rating of your ROV? Did you test this? How?
- Did you use any pressure housings in your design? Explain how you designed and built these.
- What are o-rings and how do they work?
- How much did it cost to build your vehicle?
- How much does your ROV weigh in air? In water?

Control system

- What type of control scheme have you used? Why?
- How does your control system work?
- How many conductors are in the tether?
- What devices/functions does your system control?
- Is there some unique feature of your control system?
- How did you waterproof your underwater electrical connections?

Propulsion

- How many thrusters does your vehicle have? Why?
- How much thrust does each produce?
- How many watts does one thruster use at full rpm?
- How many amps does one thruster draw under full load?
- How much electrical power does the vehicle draw when all the thrusters are in use? Have you measured this?
- Explain how you measured thrust.
- How is power (watts) used by one thruster related to the thrust it produces?
- Do you know the forward speed of your ROV? How did you measure this?

Ballast System

- How does your ROV ballast system work?
- Explain what stability is.
- Why is it important to consider stability in the design of ROVs?

Sensors

- What type of camera(s) did you choose? How did you waterproof it?
- What do your sensors measure or detect?
- What unique features are incorporated into your sensors?
- What additional sensors (other than a camera) have you put on your ROV? Why?

Payload Tools

- What type of payload tool(s) did you design to accomplish the product demonstration tasks and why?
- Explain how the tool(s) works.

Resources

- Did the project stay within budget? If not, why?
- What equipment/building supplies were donated, built, or bought? What strategies did you use in your fundraising?
- Were you able to produce a functional vehicle that can accomplish the tasks? What tasks did (or do) you still have difficulty completing?

System Design

- What are the strengths of the design? How will they affect the vehicle's performance?
- What are the weaknesses? How will they affect the vehicle's performance?
- Do the safety systems work? How did you come up with them?
- An ROV consists of many systems that are made up of many components. How did you decide which components to build and which components to buy?
- Did you reuse any components that you had built for a previous competition ROV? How did you decide which components to reuse and why?

Originality

- Does the design of the vehicle and its systems exhibit unique concepts and innovation? What are they?
- Does the vehicle make excess use of commercially-available systems? Why or why not?
- Are there any innovations or modifications that resulted in higher functionality and reduced costs?
- If you are using the same vehicle as last year, why? What are the advantages? What, if any, modifications or additions did you make?

Workmanship

- What is the overall quality of the workmanship?
- Are the electrical systems neatly contained and wired?
- Is it easy to access components for maintenance? If not, why?
- Is the tether neatly bundled and protected? How did you accomplish this?
- Can the tether withstand the strain from the vehicle weight, handling, and operation? How?
- Does the vehicle look aesthetically pleasing yet have practical functionality? Why do you think so?

Safety

- What potential safety hazards did you identify then address?
- Are warning labels and safeguards posted on potentially hazardous components?
- Did your company develop a safety checklist or protocol?

Theme

- In the real world, what role do ROVs play in the competition theme?
- What types of organizations' or individuals' work relates to the competition theme?

Preparing for your product presentation and Q&A

- Make sure that every member of your company has a good, general working knowledge of your vehicle, even though they may have specialized in one specific aspect of its design and construction.
- Research the specifications of the components that you use in your vehicle. For example, look up the specs of your ROV's camera and be familiar with such numbers as the amount of propulsive force the thrusters produce, the weight of your ROV, etc.
- Make sure that all the members of your company are familiar with your technical documentation. Ask every member to read it over to catch any errors or omissions. This exercise will help to familiarize everyone with all aspects of the project.
- Generally, you will have more to say about your ROV than can be presented in 15 minutes. That is why it is critical to organize your material and practice communicating it. However, avoid coming across as having memorized your presentation verbatim. Judges want to see that you are prepared and understand the information, not that you can simply regurgitate a rehearsed speech from memory. Ask your instructors or mentors to give you feedback.

Other important items

- If during the product presentation it becomes apparent that instructors, mentors, and other adults associated with your company exercised more than an advisory role, judges reserve the right to deduct points or, in extreme cases, disqualify companies.
- Your company is discouraged from using off-the-shelf, plug-and-play systems. You are encouraged to demonstrate innovation and creativity in the construction of your vehicle and its systems. This will also be reflected in your score.

MARKETING DISPLAY

Your company is required to create a display that will be showcased during the competition event. Your display should be an informative, clear, and concise presentation about your company and how you designed and built the specialized tools to effectively complete the product demonstrations. During the competition, your company's display will be evaluated and scored by a completely different group of working professionals – individuals who will represent science, business, government, industry, and education/outreach.

While some judges will have a technical background, others will have a communications, marketing, or public relations background. In addition, there will be visitors to the competition who may not completely understand what an ROV is or how it is used. Think of these visitors as potential future clients who may authorize funding for your work, but have a limited understanding of the technology (i.e., you need to explain your technology, the tasks at hand, and “sell” them on YOUR products and services). Design your display to communicate to this type of audience.

Each judge will award a score (50 points max). Judges' scores and comments will be returned to you shortly after the event.

New for 2017!!! The MATE Center will NOT supply display boards for the international competition this year.

You must provide your own display board. The space that the text and photographs/graphics occupy CANNOT exceed 36" tall by 48" wide. For example, company names CANNOT be mounted above the display board. NO EXCEPTIONS!

At the international competition, tables will be provided for the displays.

MATE will provide scissors, tape, glue sticks, adhesives, and other means of attaching display items to the presentation board, although you are also welcome to bring your own.

The guidelines and required components for the marketing display are:

Note: Keep in mind that, at the international competition, with up to 60 marketing displays to score, the judges will have approximately 10 minutes to evaluate your display. Make key points. Be concise. Keep the general public in mind. Also, make sure to label any and all figures, graphs, diagrams, and photographs.

GENERAL GUIDELINES

- The space that the text and photographs/graphics occupy **CANNOT** exceed 36" tall by 48" wide.
- Font size that is clearly legible from a distance of 1.5 m
- Choose a font style and use it throughout
- All measurements are in SI units (metric). Exceptions include ½-inch PVC pipe and other items described or sold in imperial units.
- Include headers (see **REQUIRED COMPONENTS** below)
- Photos should be clear and high-quality for the print sizes that you choose
- **EVERY PHOTO MUST HAVE A CAPTION!** No caption = no credit for that photo. Also include photo credits if the photo was not taken by someone in your company.
- **Items that you MAY include on your marketing display:**
 - Diagrams or sketches (CAD drawings, for example). The diagrams should be clearly labeled with a brief explanation that is understandable to a general, non-technical audience. For example, technical – a photo caption reading "ROV control system (Radio Shack project box part #123) with 3 DP/DT momentary switches (part #444)" vs. non-technical – "a photo of the ROV highlighting its control system." If they are overly complicated and require more technical knowledge, do not include them; technical drawings belong in your company's technical documentation.
- **Items that you MAY have on display include:**
 - Photo journals, pamphlets
 - Copies of your company's technical documentation
 - Resumes and business cards of the members of your company
 - Company Spec Sheet and safety manual
 - Descriptions of mentoring or community outreach that your company participated in
 - MEDIA OUTREACH (international competition ONLY)
- **Items that you MAY NOT include in your marketing display:**
 - Flip charts on the poster board
 - Video screens on or in the actual poster board

REQUIRED COMPONENTS

Note: The following are REQUIRED headers. These headers not only assist the judges in evaluating your display, they also make your marketing display easy to read.

- **Company name and school, club, or community organization name (note that this is the only personalized header)**

Make sure that your company name is in large, bold font (larger than any other font on your marketing display). Include your school, club, or community organization name as well as your company name. Include your geographic location (i.e. city, state, and country).
- **Abstract (concise – 250 word limit)**

Include an introduction to your company and how your company designed and built specialized tools to effectively complete the product demonstration tasks. Make sure to relate the product demonstration to how ROVs can be used in the real world. Don't assume that your audience knows

what an ROV is or the details about the competition tasks. You can view this section as a summary of your company information, design rationale, and theme.

- **Company information**

Include photo(s) (group or individual) of all of the members of your company. Provide a brief description of each member. This description should include the person's name, role in the company (e.g. CEO, CFO, design engineer, pilot, marketing and communications specialist, etc.) and their qualifications, such as grade level, major or area of expertise, career goals, etc.

- **Design rationale**

This section should be the bulk of your marketing display. It will be worth the most points.

- Why did your company build your ROV the way that you did?
- Present your ROV's "Features and Benefits." Features are the physical aspects or specifications for your vehicle, and benefits are what those features provide for the customer. For example, a feature might be a one horsepower thruster; the benefit would be the ability to make headway in a 2 knot current.
- Highlight your vehicle's safety features.
- Include photos of your ROV. Make sure to highlight the various systems of your vehicle.
- **Include photos or drawings of any special features of your vehicle and how these features relate to the product demonstration tasks, safety, general operations, etc.**
This is the most important part of your design rationale.

Last year's winning marketing displays are examples of how you can effectively present this information to a non-technical audience. The 2015 top EXPLORER and EXPLORER marketing displays are published [here](#) in the Journal of Ocean Technology.

- **Theme**

Describe this year's competition theme and how ROVs are or could be used to support port security, health, commerce, and tourism.

Rather than regurgitating information that you find within the competition manual or on the Internet, take the time to think through the competition challenges and their significance in the real world. You can choose to focus on the technical, economic, or socioeconomic issue. In addition to the Internet, you are encouraged to contact individuals (such as a local scientist or industry professional) who can offer their views. You should include appropriate photos, diagrams, or sketches with captions. Be sure to appropriately cite your references / sources at the bottom of this section.

- **Company Evaluation/Market Assessment**

Answer the following questions thoroughly and thoughtfully:

- How would you characterize your company's overall success?
- What do you consider strengths of your company and the ROV you designed?
- What areas do you see needing improvement?
- What was the most rewarding part of this experience?
- What would you do differently next time?

▪ **Acknowledgements**

Please list your sponsors (companies, organizations (including the MATE Center), professionals from industry, and/or mentors) and the type of support that they provided (funds, building supplies, equipment, site visits to facilities, time, and/or technical expertise). You can include organizations and/or individuals that provided logistical and/or moral support (e.g. your parents, siblings, or pets). Regional competition companies should also acknowledge regional contest supporters.

Note: “Accessories” such as video footage, PowerPoint slide presentations running on laptop computers, video projections, etc. are permitted but should be used with discretion. Remember that the judges will have a limited amount of time to evaluate your marketing display and may find excessive use of audio or video presentations distracting.

However, if you do make a video of your ROV building or competition experience, please submit information about it to the [MATE Center](#) so that it can be shared via MATE’s YouTube and Vimeo channels.

***NEW IN 2017!* OUTREACH AND INSPIRATION**

The MATE Center uses underwater robotics to inspire and encourage students’ interest in STEM (science, technology, engineering, and math) education and careers. Recognizing that the students who participate in MATE competitions are powerful ambassadors for the program and MATE’s mission, the MATE Center is adding the opportunity for companies to earn up to 10 bonus points for taking part in “outreach and inspiration.”

Outreach and inspiration includes, but is not limited to, the following:

- Mentoring
- Engaging the community
- Media Outreach

Outreach and Inspiration efforts will be reviewed by competition coordinators and awarded 0 to 10 bonus points, depending on the number and scope of the outreach activity(s), i.e., the number of other students or members of the community engaged, the number of mentoring sessions, etc.

For the international competition, the deadline for submitting this information is June 9th.

Mentoring consists of, for example, providing guidance to other students in your area who are designing and building an ROV for the competition or a science or other project.

Engaging the community includes demonstrating your ROV and sharing information about your company at festivities and other community-wide events. Presenting to a Rotary Club or your school districts board of directors are other examples.

Please submit information about your mentoring and engaging the community efforts via the form located here – <https://www.emailmeform.com/builder/form/V90b3b7Fc6D23>, using the following naming convention: School or organization name_company name_Inspiration and Outreach ##_2017, where ## is the number of the document uploaded. You can upload a variety of file types (pdfs, jpegs, etc.) and multiple files, but the size of each file should not exceed 2MB. Number each file to distinguish between them. Make sure to include the following information in your write-up:

- Type of activity (e.g. mentoring, exhibiting at a community event)
- Locations, dates, and the amount of time spent on the activity
- Number of students or community members (if a large event, this can be an approximate) involved
- Description of your actions, outcomes, and other information that helps to demonstrate the quality of your time and efforts

Media outreach consists of:

- Developing a list local media contacts
- Writing a press release about your participation in the MATE ROV competition
- Distributing it to your media contacts
- Following up with your media contacts to see if they're interested in your company and its ROV
- Compiling a summary of results

For the international competition, submitting your results electronically via the form located here – <https://www.emailmeform.com/builder/form/V90b3b7Fc6D23>, using the following naming convention: School or organization name_company name_Inspiration and Outreach ##_2017.

Please submit a copy of your press release, a copy of your media contacts list, and a summary of news articles, TV or radio coverage, etc. that your company received. Include copies of articles and URLs, and list any television or radio coverage. Be sure to include name of outlet, date, and a summary of the coverage. You can upload a variety of file types (pdfs, jpegs, etc.) and multiple files, but the size of each file should not exceed 2MB.

Media Relations Guidelines

Here are some general guidelines for working with the media. They are specific to the international competition, but can be easily modified for regional events.

1. You should begin your media effort about 4-5 weeks before the international competition (which is from June 23 – 25, 2017).
2. Write a press release highlighting your company's involvement in the upcoming MATE competition. If you participated in a regional, feel free to talk about it and how you performed. It doesn't have to be more than 1-1 ½ pages, double-spaced. Be creative.

3. Develop a list of community news media contacts, including newspapers, magazines, radio stations with public service announcements and local news, television news programs, and local online news reports or blogs. If your town is small and doesn't have any media outlets, reach out to those in the city or large town that's closest to you.
4. Try to find the name and email address of a reporter who covers education or technology—they're the ones that will be most interested in your story. You can often find this information online, or you may have to call the media outlet and speak with a receptionist to find out who the most appropriate contact is and how to reach them. Usually, email is the best way to contact a reporter.
5. Become familiar with the news outlets and the reporter that you're going to "pitch" your story to. For example, learn if they've written about your school before, or what kinds of news stories they tend to develop.
6. Compose an email introducing yourself, your company, and your school. Tell them that you're participating in the Marine Advanced Technology Education (MATE) Center's international ROV competition, which will be held in June 2017 at Long Beach City College in Long Beach, California. Explain what ROV stands for, and tell them how ROVs are used in the real world. Give examples of the skills that you and your teammates have learned by designing, building, and piloting ROVs. You may have already written some of this information for your marketing display or technical documentation.
7. Reporters are interested when a local team is participating in an international event. So make sure to let them know that the MATE competition is an international competition, funded by the National Science Foundation, the Marine Technology Society ROV Committee, and other international organizations and businesses, and that teams from all over the world participate. Be sure to provide the link to the [ROV competition web site](#).
8. Copy and paste the press release in the body of your email. (Reporters in general prefer cut and pasted releases to opening up an attachment.) If you have any photos of your company and/or ROV, especially a photo of your vehicle in action, feel free to attach the photo to the email. Explain to the reporter what's going on in each photo you attach.
9. Make sure you include your name and a phone number where the reporter can reach you. Also include MATE's contact information and let them know they can contact MATE (via Jill Zande at jjzande@marinetech.org) if they want more specific information about the program or event.
10. After you've emailed your media contacts, wait for a week and email them a reminder if you don't hear back from them.
11. If a reporter calls and wants more information, be creative about how you provide it. Offer to give interviews with a few of the company members, your mentor, or even a key sponsor. Invite them to meet you at the pool to see your ROV in action. Ask them if they want to try piloting the ROV on their own. If they want to speak with someone from MATE, give them the MATE media contact information from above.
12. If your company receives media coverage, capture the URL of the article, video or audio. If not, scan in any printed articles, or for audio/video, list the name of the media outlet, name of reporter, date and time of broadcast and summary of the broadcast. Include these in your electronic submission.

Below is the sample press release to help you get started.

Bridgewater High School Students to Participate in International Underwater Robotics Competition

~~~~~

### **Local students develop underwater robots and learn how they help to keep our seaports safe at MATE International ROV Competition to be held at Long Beach City College**

April 15—Bridgewater, Mass.—A team from the Bridgewater High School (BHS) has been selected to compete the Marine Advanced Technology Education (MATE) Center’s 16<sup>th</sup> Annual International Student ROV Competition. Remotely operated vehicles, or ROVs, are tethered underwater robots used to complete tasks in underwater environments. The BHS team will compete against more than 60 teams from around the world, using an ROV that they designed and built during the past school year.

At the International ROV Competition, which will be held June 23 – 25 in Long Beach, California, BHS will compete against the top teams from MATE’s network of regional competitions. BHS was one of the winners in the MATE New England Regional ROV Contest, which was held last week.

Each year, MATE’s ROV competition encourages students to learn and apply science, technology, engineering, and math skills to complete tasks that simulate real-world problems from the ocean workplace. To learn entrepreneurial skills, student teams must form “companies” that produce ROV products to complete a specific set of tasks.

This year, the contest focuses on how ROVs are used to ensure the health and safety of our seaports – from monitoring cargo containers to cleaning up contaminants on the seafloor. Long Beach City College (LBCC) will host the competition events. Established in 1927, LBCC is one of California’s 113 community colleges. The college offers a variety of certificate and degree programs, including Electrical Technology, to nearly 25,000 students each semester.

Teams will participate in ROV product demonstrations that require them to pilot their vehicle to complete tasks such as constructing an underwater “hyperloop” system, sampling sediment for contaminants, investigating containers that fell from a cargo ship to the seafloor, and repairing a fountain used in a water and light show. In addition, teams must prepare technical documentation for their vehicle, make a product presentation to a panel of judges, and create a marketing display.

This is the fifth year that the BHS ROV team has participated in the New England Regional ROV Contest, and the third year it has attended the MATE International ROV Competition. The team is supported by local sponsors, including Tom’s Hobby Shop, East Bay Marina, and Schaumberg Electronics.

For more information about the BHS ROV team, please contact team marketing coordinator Jill Smith at (831) 555-1234 or [email@email.com](mailto:email@email.com).

For more information about the MATE ROV competition, visit [www.marinetech.org/rov-competition/](http://www.marinetech.org/rov-competition/) or contact Jill Zande at [jzande@marinetech.org](mailto:jzande@marinetech.org).

- ### -