



2021 EXPLORER CLASS



MOTOROLA SOLUTIONS
FOUNDATION

FOUNDATION

Good for Good

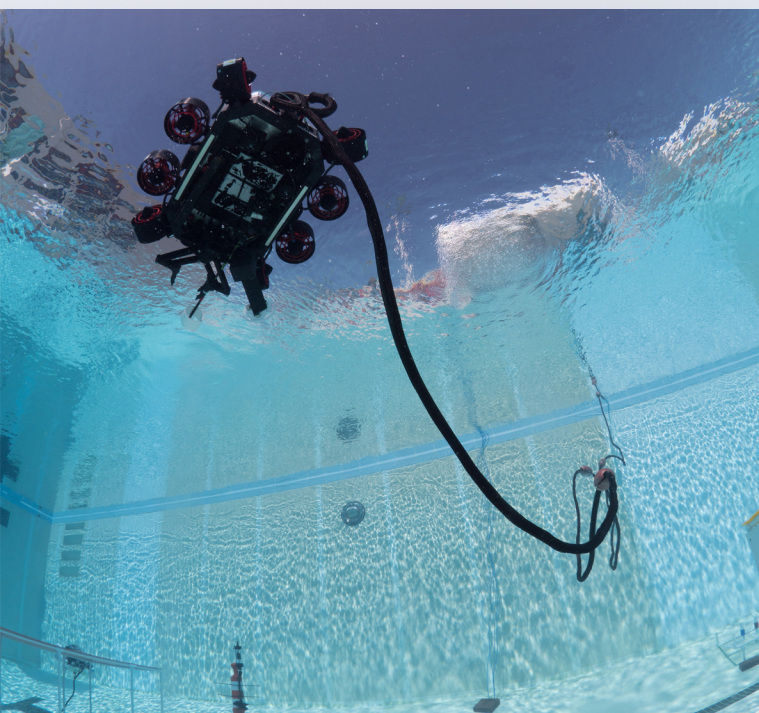

2021 MATE ROV COMPETITION:

Excite, Educate, Empower: Students engineering solutions to global problems

EXPLORER CLASS COMPETITION MANUAL

For general competition information, including a description of the different competition classes and eligibility requirements, visit [Start Competing](#).

CONTENTS

2021 MATE ROV COMPETITION:	1
<i>Excite, Educate, Empower: Students engineering solutions to global problems</i>	1
EXPLORER CLASS COMPETITION MANUAL	1
OVERVIEW	4
THINK OF YOURSELVES AS ENTREPRENEURS	4
EXPLORER CLASS DEMONSTRATION	4
PART 1: PRODUCT DEMONSTRATION	7
OVERVIEW	7
SCORING OVERVIEW	7
TIME	8
CONTEXT	9
NEED	9
REQUEST FOR PROPOSALS (RFP)	10
SIZE AND WEIGHT RESTRICTIONS	23
PRODUCT DEMONSTRATION	26
TASK 1: THE UBIQUITOUS PROBLEM OF PLASTIC POLLUTION	26
TASK 2: THE CATASTROPHIC IMPACT OF CLIMATE CHANGE ON CORAL REEFS	29
TASK 3: MAINTAINING HEALTHY WATERWAYS II: DELAWARE RIVER AND BAY	38
PRODUCT DEMONSTRATION RESOURCES	44
PRODUCT DEMONSTRATION RESPONSIBILITIES	44

PART 2: PRODUCT DEMONSTRATION PROP BUILDING INSTRUCTIONS & PHOTOS..45

PART 3: VEHICLE DESIGN & BUILDING SPECIFICATIONS..... 45

1.0 GENERAL..... 45

2.0 SAFETY 45

2.1 Job Site Safety Analysis..... 46

2.2 Safety Pre-Inspection..... 47

2.3 Onsite Safety Inspection 51

2.4 Safety inspection protocol 51

2.5 Safety Inspection Points 52

3.0 SPECIFICATIONS..... 52

3.1 Operational..... 52

3.2 Mechanical/Physical 54

3.3 Electrical 55

3.4 Onboard Electrical Power..... 61

3.5 Power Shutdown 62

3.6 Fluid Power 62

3.7 Control Systems 66

3.8 Command, Control, & Communications (C3)..... 66

3.9 MATE Provided Equipment 67

3.10 Laser Safety Rules 68

PART 4: COMPETITION RULES..... 69

4.1 GENERAL 69

4.2 PROCEDURAL 70

4.3 DESIGN & SAFETY CONSIDERATIONS..... 73

PART 5: ENGINEERING & COMMUNICATION..... 75

5.1 COMPANY SPEC SHEET 75

5.2 TECHNICAL DOCUMENTATION 76

5.3 ENGINEERING PRESENTATION 77

5.4 MARKETING DISPLAY 78

5.5 CORPORATE RESPONSIBILITY 80

TIPS FOR EFFECTIVE WRITTEN AND ORAL COMMUNICATION 81

PART 6: SUBMISSION GUIDELINES AND KEY DEADLINES 82

6.1 Documentation 82

6.2 KEY DEADLINES 84



This work is licensed under a [Creative Commons Attribution-NonCommercial-NoDerivatives 4.0 International License](https://creativecommons.org/licenses/by-nc-nd/4.0/). Under this license you may download this document. Please give credit to the MATE Center and MATE II. You may not use these materials for commercial purposes without written permission from the MATE Center and MATE II. Please click on the Creative Commons link above for license details.

www.marinetech.org

www.mateii.org

OVERVIEW

THINK OF YOURSELVES AS ENTREPRENEURS

From the removal of plastic pollution in our oceans to the assessment of the health of coral reefs and maintenance of healthy waterways, individuals who possess entrepreneurial skills are in high demand and stand out in the crowd of potential job candidates. What are entrepreneurial skills? They include the ability to understand the breadth of business operations (e.g., finances, research and development, media outreach), work as an integral part of a team, think critically, and apply technical knowledge and skills in new and innovative ways. Individuals who develop a mindset for innovation and collaboration will be well prepared for the global workplace and ready to tackle today – and tomorrow’s – societal and environmental challenges.

To help you to better understand and develop these skills, the MATE ROV competition challenges you to think of yourself as an entrepreneur. Your first task is to create a company or organization that specializes in solutions to real-world marine technology problems. Use the following questions as a guide.

- What is your company name?
- Who are its leaders – the CEO (chief executive officer – the leader) and CFO (chief financial officer who oversees the budget and spending)?
- Who manages Government and Regulatory Affairs (i.e. who’s in charge of reviewing the competition rules and making sure that they are understood and followed by everyone)?
- Who is responsible for research and development (R&D)?
- Who is responsible for system(s) engineering? Design integration? Testing? Operations?
- Who is responsible for fund-raising, marketing, and media outreach?
- What other positions might you need? (Depending on your personnel resources, more than one person may fill more than one role.)
- What products and services do you provide?
- Who are your potential clients?

In this case, the MATE ROV Competition and the global community are your “clients” who recently released a request for proposals. A request for proposals (RFP) is a document that an organization posts to solicit bids from potential companies for a product or service. The specifics of your product design and rules of operation as well as the specifics of your product demonstration are included below.

EXPLORER CLASS DEMONSTRATION

All EXPLORER class companies are required to submit a video that:

- Demonstrates the ability of their vehicle to perform specific tasks;
- Shows compliance with MATE’s design, build, and safety specifications.

Video specifications:

Video specifications: The video **MUST** show the following ROV features for the specified amount of time. Companies can choose to narrate the video to help explain how their vehicle meets these

required specifications. Alternatively, a MATE official may schedule a Skype, Google Hangout, GoToMeeting, Zoom, Webex or other type of video conferencing session with the company. During the session, companies must visually show, and answer questions about, the following ROV features.

The video MUST show in this order:

1. 15 seconds (or more) of the 48-volt power supply **(ELEC-002E)**.
2. 15 seconds (or more) showing a properly sized Littlefuse. The company MUST use a ruler to show that this fuse is within 30 cm of Anderson Powerpole connectors. **(ELEC-008E, ELEC-010E)**.
3. 30 seconds (or more) of the inside of the control box showing the wiring and components. MATE will be looking for:
 - No exposed wiring **(ELEC-017E)**.
 - That the control box is neatly laid out with attention to workmanship. **(ELEC-022E)**.
 - Separation and identification of 120VAC wiring from DC and control voltages. **(ELEC-023E)**. If 120VAC is not used in the control box, you should video a slide stating that AC power is not used in the control box.
4. 15 seconds (or more) in the control system showing that there is no conversion of the 48V until it reaches the ROV. Power supplies, ESCs, H-Bridges or other voltage conversion devices are not allowed on the surface. **(ELEC-003E & ELEC 004E)**
5. 30 seconds (or more) showing any hydraulic / pneumatic systems including a pressure release valve and regulator in the system **(FLUID-007, FLUID-011)**, and that any pressurized cylinder, pressure storage device meets the MATE specifications of **(FLUID-012, FLUID-013)**. In addition, the type of fluid should be clearly stated in the video **(FLUID-002, FLUID-003, FLUID-004)** If the vehicle does not use fluid power, **you should video a slide stating that Fluid Power is not used on this ROV for 10 seconds.**
6. 15 seconds (or more) showing the tether entering the ROV and strain relief for the tether **(ELEC-024E)**
7. 60 seconds (or more) total, 10 seconds (or more) per side of the ROV (4 sides plus top and bottom) showing that all motors are waterproofed and propellers are shrouded and protected with guards. There are no sharp edges or elements of the ROV that could cause damage **(MECH-006, ELEC-017E)**.

Video demonstrating specific tasks: Following those requirements, the video must demonstrate that the ROV can complete the following product demonstration tasks. The ROV must complete all the tasks within 15 minutes.

The UNCUT video must show the vehicle:

1. Launching safely from the side of the pool and maneuvering to tasks.
 - a. See specifications **(MECH-004 & MECH-005)**.
2. Completing the required tasks. This includes:
 - a. **Task 1:** The Ubiquitous Problem of Plastic Pollution

- i. Removing a ghost net from midwater
 - 1. Pulling a pin to simulate cutting the ghost net free
 - 2. Removing the ghost net from the water
- b. **Task 2:** The Catastrophic Impact of Climate Change on Coral Reefs
 - i. Propagating corals onto the reef
 - 1. Removing one coral fragment from the nursery structure
 - 2. Outplanting one coral fragment to the designated location on the reef
- c. **Task 3:** Maintaining Healthy Waterways II: Delaware River and Bay.
 - i. Creating a photomosaic of a subway car submerged to create an artificial reef
 - 1. Position your ROV at five locations around the subway car

Task 1: The pin on the ghost net must be positioned in the midwater, at least 50 cm above the bottom of the pool.

Task 2: Companies only need to remove and outplant one coral fragment. Companies may choose to use either design (branched or unbranched) of coral fragment.

Task 3: Companies do not need to create a photomosaic for the video demonstration. To complete this demonstration, the ROV must position itself with the front of the ROV facing each side of the subway car and also position itself directly above the subway car.

The camera angle must demonstrate that the ROV is under its own power and not assisted by humans when in the water. The MATE ROV Competition requires that the camera show the complete ROV in the field of view at all times. A video that cuts between camera angles will not pass the demonstration requirement of “uncut” footage. The video is permitted to show a split screen or may incorporate a separate window showing the ROV camera or other footage. However, the video **MUST** show an uncut view of the vehicle from launch to completion of the tasks. The tasks must be completed within 15 minutes.

Companies may complete the tasks in any order they wish.

* Companies that advance from an EXPLORER class regional with 5 teams or more are not required to submit a video showing completion of the required tasks. **However, these companies must still submit the required specifications video.**

See [6.1.1 Video Demonstration Documentation](#) for submission information.

Companies are allowed to make minor changes to their ROV after their video demonstration, but the overall systems should be the same. Minor changes include adding/removing buoyancy, adding tools/sensors that were not used for the demonstration, etc.

NOTE for 2021!!!

Due to the continued impact of the pandemic, EXPLORER class teams are NOT encouraged to attend RANGER/NAVIGATOR/SCOUT regional events this competition season to showcase their vehicle. While

both EXPLORER class teams and regional events benefit from this experience, in the interest of the health and safety of all participants, we are discouraging participation this year. We are hopeful to resume the opportunity (and encouragement!) for EXPLORER teams to attend, showcase their ROVs, and support regional events in 2022.

PART 1: PRODUCT DEMONSTRATION

OVERVIEW

EXPLORER class companies will take part in ONE product demonstration that consists of three distinct tasks. Companies will get two attempts at the one product demonstration:

TASK #1: THE UBIQUITOUS PROBLEM OF PLASTIC POLLUTION

TASK #2: THE CATASTROPHIC IMPACT OF CLIMATE CHANGE ON CORAL REEFS

TASK #3: MAINTAINING HEALTHY WATERWAYS PART II: DELAWARE RIVER AND BAY

The product demonstration score will be added to your [ENGINEERING & COMMUNICATION](#) and [SAFETY](#) scores to determine your total, overall score for the competition.

SCORING OVERVIEW

The competition consists of product demonstrations, engineering and communication, and safety with the following scoring breakdown:

- **Product demonstrations)**
 - 270 points (max), plus a time bonus
 - Size and weight restrictions
 - 20 points (max)
 - Product demonstration organizational effectiveness
 - 10 points (max)
- **Engineering & Communication**
 - Technical documentation
 - 100 points (max)
 - Engineering presentations
 - 100 points (max)
 - Marketing displays
 - 50 points (max)
 - Company Spec Sheet
 - 20 points (max)
 - Corporate Responsibility
 - 20 points (max)
 - Virtual Reality assets
 - 25 points (max)
- **Safety**

- Initial Safety and Documentation Review
 - 20 points (max)
- Safety Inspection
 - 30 points (max)
- Job Safety Analysis (JSAs)
 - 10 points (max)

TOTAL POINTS = 675

TIME

Each product demonstration includes:

- 5 minutes to set up at the product demonstration station
- 15 minutes to attempt the tasks
- 5 minutes to break down and exit the product demonstration station

Your company will have 5 minutes to set up your system, 15 minutes to complete the tasks, and 5 minutes to demobilize your equipment and exit the product demonstration station. During the 5-minute set-up, you may reassemble your vehicle after the size determination and weigh-in and place it in the water for testing and/or trimming purposes. The 15-minute demonstration period will begin after the full 5 minutes of set up time expires, regardless of whether the company is ready to start the product demonstration. It may begin sooner if your CEO notifies the product demonstration station judges that your company is ready to begin.

At any time during the demonstration, you may pilot your ROV to the surface and remove the vehicle from the water for such things as buoyancy adjustments, payload changes, and troubleshooting, but the 15-minute product demonstration clock will only stop if a judge determines it is necessary for reasons beyond your control. Otherwise, the clock will only stop after all of the tasks are successfully completed, the ROV has returned to the surface under its own power so that it touches the side of the pool, and a company member at the product demonstration station has physically touched the vehicle. Your ROV is not required to return to the surface between tasks.

Your 5-minute demobilization will begin as soon as the 15-minute demonstration time ends, regardless of where your ROV is located (i.e., still at depth, on the surface, etc.).

TIME BONUS

Companies will receive a time bonus for each product demonstration if you:

- 1) successfully complete all the tasks,
- 2) return your ROV to the surface under its own power so that it touches the side of the pool, and
- 3) physically touch your vehicle before the demonstration time ends.

Companies will receive 1 point for every minute and 0.01 point for every second under 15 minutes remaining.

CONTEXT

“What we have out there is all we have; there is no more.”

- Dame Ellen MacArthur, *Founder and Chair of Trustees, Ellen MacArthur Foundation*

Each year, the MATE ROV Competition brings together a global community of learners to tackle real-world problems from around the world. This year, the competition is challenging this community to tackle problems that impact the entire world. Plastics clogging our rivers, lakes, waterways, and ocean, from the surface to the bottom of the Mariana Trench. Climate change raising ocean temperatures, affecting the health of coral reefs. Contaminants in our waterways. You can find these scenarios from Pennsylvania to Portugal, Florida to Australia, the Western Pacific to the Mid-Atlantic, and Indianapolis to Indonesia.

NEED

This year the “client” is us – our global community – and the request for proposals (RFP) is simple: design and build a remotely operated vehicle and the necessary sensors and tooling to tackle the real-world problems of plastics in our ocean, climate change’s impact on coral reefs, and the consequences of poor environmental practices on our inland waterways.

In all of three of these cases, your solutions will focus on remediation, meaning, cleaning up rather than fixing the root of these problems. Addressing the actual cause will take involvement from more than just the MATE ROV Competition community; it will take government agencies, non-governmental organizations (NGOs), corporations, small businesses, research institutions, professional societies, and the general public all working together.

Fortunately, momentum is building.

More and more companies are starting to take environmental, social, and governance (ESG) factors into consideration when making business decisions. ESG factors cover a wide range of topics that are not traditionally part of financial analysis, yet may be important financially when it comes to attracting employees, business partners, and, perhaps most importantly, customers. ESG factors include how corporations respond to climate change, how good they are with water management, how effective their health and safety policies are in the protection against accidents, how they manage their product supply chains, how they treat their employees, and whether they have a corporate culture that builds trust and encourages innovation.

The term ESG was first used in 2005 in a study entitled “Who Cares Wins.” The study was lead by the United Nations and involved 20 financial institutions from around the world. Its goal was to develop guidelines and recommendations on how to better integrate ESG factors into financial markets and researching and managing investments. At the end of the study, all of the institutions committed to start talking with their stakeholders – investors and corporations – about how to implement the study’s recommendations. They were convinced that the only way to make changes and improvements is to get everyone on board.

Fifteen years later, there has been progress, but there is still a long way to go. The biggest challenge for most corporations is adapting to a new environment that favors smarter, cleaner, and healthier

products and services and moving away from the mindset of the industrial era when pollution was tolerated, labor was just another cost (and not real people), and bigger was better (and meant more money). Getting everyone thinking the same way and viewing the world as Dame Ellen MacArthur does is going to take a lot more work. However, what we do here is a start.

Before launch and operations, the ROV must complete a series of “product demonstrations” staged at a swimming pool at various regional locations. (Depth requirements vary depending on competition class; see **SPECIFICATIONS** below.) Companies that successfully complete the product demonstrations and deliver exceptional engineering and communication components (e.g. technical documentation, engineering presentations, and marketing displays) will be awarded the contract.

(Visit www.youtube.com/watch?v=Tn-jUbpFV4A for sound advice from MATE judge Marty Klein. He references 2015, but his words still hold true for each and every competition season!)

REQUEST FOR PROPOSALS (RFP)

1. General

a. The Ubiquitous Problem of Plastic Pollution



Photo source: stock.adobe.com

While the above image is colorful and artistic, it is also bleak and disturbing – especially when you consider that plastics outnumber larval fish in some coastal nurseries. Off the Big Island of Hawaii scientists studying features called “ocean slicks” – ribbons of calm water that form naturally on the ocean’s surface and where larval fish come to feast on an abundance of prey – found that prey-sized plastics also accumulate in these fish nurseries, outnumbering the fish 7-to-1 and ending up in the

stomachs of many. Admittedly, little is known about the consequences of larval fish ingesting plastics, but it can't be good for them. Plastic ingestion by adult fish has been linked to liver toxicity, tumors, malnutrition, behavioral problems, and death. Without a fully developed liver that can filter toxins, these effects could be even worse in larval fish.

So, add the following image to those of sea turtles with plastics straws stuck in their nostrils or caught in plastic nets. Along with the image, you can add the potentially far-reaching ecological and socioeconomic impacts of plastic accumulation in larval fish nurseries to the list of consequences of the ubiquitous problem of plastic pollution in our oceans.



Photo source: https://i.kinja-img.com/gawker-media/image/upload/s--Vg9gBDua--/c_scale,fl_progressive,q_80,w_800/fb9osojkxv5r9qb5l8kv.jpg

Will Who Cares Really Win?

There is a growing awareness of the detrimental impact of plastic pollution, and many parts of the world are taking substantive action to curb it. Realistically, however, it is unlikely that the entire world population will discontinue the use of plastic in everyday life; in many instances plastic products have made life easier, more comfortable, and safer. In some parts of the world, access to plastic products is a symbol of economic prosperity.

But there are steps we can and are taking to curb its use (i.e., reusable plastic bags) and find alternatives (i.e., metal straws). In addition, research into “smarter” plastics that breakdown more rapidly into less harmful molecules, or can more easily recycle into other products to eliminate single-use plastics – coupled with the development of technologies that clean-up existing plastics – can allow us to continue to use this material while applying the values of ESG. In the words of David Golden, former Senior Vice President and Chief Legal Officer at Eastman Company, “a sustainable company creates significantly more value in the world than the resources it consumes.”

Yes, who cares really will win.

Take, for example, Pete Ceglinski, CEO of the Seabin Project. An Australian surfer and water enthusiast, Pete was concerned about plastics and other pollutants in the ocean. So he and a fellow surfer decided to quit their jobs and do something about it. They became entrepreneurs, researched potential

solutions to clearing trash from the water, designed and developed the Seabin, and marketed it to the world.

Pictured below, the Seabin is essentially a floating garbage bin. Water is sucked in from the surface by a submersible water pump then passes through a catch bag inside the bin. The catch bag is comparable to a garbage bag liner; it can capture and retain microplastics down to 2 millimeters in size, while a pad at the bottom of the bin filters out oil and other contaminants. Once full, the catch bag can be emptied then replaced within the unit.

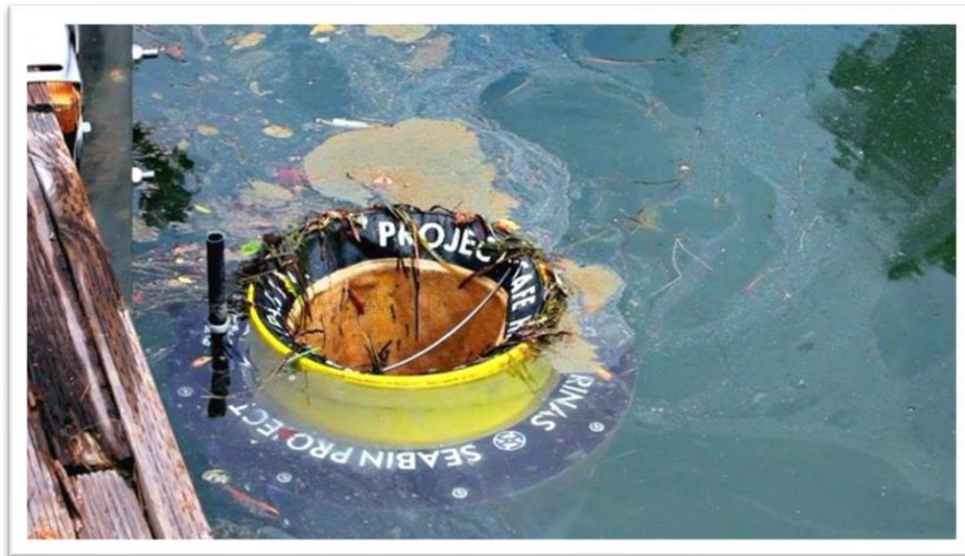

Photo source: <https://www.sail-world.com/news/219741/Fight-against-pollution-with-Ocean-Vacuums>

Since Ceglinski and his partner first started their “socially-driven business model” in 2014, nearly 900 Seabins have been installed in harbors, marinas, and commercial ports around the world. (The first Seabin on the east coast of the United States was installed in a marina in Norfolk, Virginia near Nauticus, the National Maritime Center – the organization that coordinates the MATE Mid-Atlantic Regional ROV Competition!) These are ideal locations because they tend to be in calmer waters, are areas where trash accumulates, and provide easily accessible and unlimited power, which allows the Seabin to work 24 hours a day, seven days a week. Case in point; to date Seabins have captured a total of 360,000 kilograms of trash.

Ceglinski and his partner are now working on a Seabin for the open water, which would allow them to tackle the immense “garbage patches” of plastics that collect in ocean gyres, including the infamous Great Pacific Garbage Patch. How to power those Seabins far from shore is one of the technological and logistics challenges they face, but they are exploring the use of renewable sources – wind, solar, and wave.

Another example is businessman and explorer Victor Vescovo, shown in the picture below. In May 2019, Vescovo became only the fourth person in history to travel to the bottom of the deepest part of

the world ocean, the Mariana Trench. Working with The [Five Deeps Expedition](#) and its submersible *Limiting Factor*, Vescovo actually set a new record by traveling deeper than the previous three; he “bottomed out” at 10,928 meters. Like oceanographer and inventor Jacques Piccard and U.S Navy Lieutenant Don Walsh in 1960 and movie producer/director James Cameron in 2012, Vescovo excitedly peered out his portal when his submersible hit bottom and sent sediment swirling. When the dust settled, he found a “sublime and serene” landscape dotted with translucent fish, a new species of amphipod, and...candy wrappers. As the Washington Post reported, we are going places no one has gone before, but our trash is already there. And in the words of Vescovo, “I was disappointed to see human contamination in the deepest point in the ocean. With over 7 billion people on the Earth, the oceans are going to be impacted negatively by mankind, but I hope we can at least minimize it in the future.”



Photo source: <https://www.lonelyplanet.com/articles/plastic-waste-mariana-trench>

b. Catastrophic Impact of Climate Change on Coral Reefs



Photo source: <https://www.hawaiipublicradio.org/post/corals-are-adapting-higher-temperatures-likely-not-fast-enough#stream/0>

While not nearly as colorful or artistic as the “plastic world” image above, this photo is equally as bleak and disturbing. It shows bleached and partially dead coral in Kaneohe Bay on the windward side of the Hawaiian island of Oahu. Scientists conducting transects of the reef documented the decimation, which results when environmental stressors like rising water temperatures cause the coral to expel the symbiotic algae that live within their tissues, which in turn causes them to turn completely white. Without their major food source and if the stress continues, the corals will die.

However, in addition to scenes like this, scientists also collected evidence that some species of coral have been adapting to warmer conditions. There are certain species in Kaneohe Bay today that are more resilient to high water temperatures than colonies from the 1970s, all through natural adaptation. While this may be reason to celebrate, adaptation may still not be enough; temperatures are increasing faster than the corals can adapt. Scientists caution that no other changes can substitute for reducing the atmospheric carbon emissions that are driving ocean temperatures higher each year.

In addition to the anthropogenic stressor of climate change, corals face natural threats, including predators like the Crown of Thorns sea star. The Crown of Thorns sea star is found throughout the Pacific as well as the Indian Ocean and the Red Sea. Its population is usually kept in check by the Triton’s trumpet, a large species of gastropod, the harlequin shrimp, and several species of reef fish apparently undeterred by its poisonous spines. However, outbreaks do occur, fueled by run-off and exacerbated by warmer waters – conditions that also directly stress corals. Corals get a one-two punch and, too often, it is too much for them to survive.

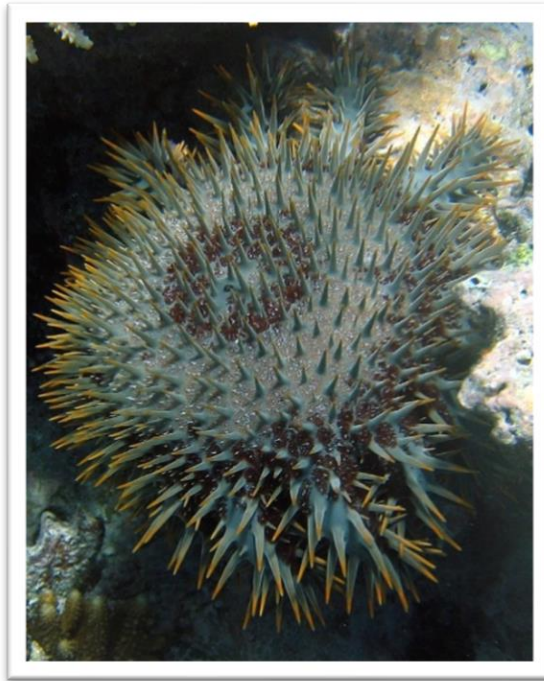

Photo source: https://en.wikipedia.org/wiki/Crown-of-thorns_starfish

Will Who Cares Really Win?

The catastrophic impact of climate change on coral reefs isn't unique to corals in Hawaii and the western Pacific. There are scenes of bleached and dying corals throughout the Caribbean and the south Pacific. However, the way that researchers are raising and transplanting coral species to replenish and repopulate the reef is. Scientists on Oahu have transplanted corals from the reef to tanks to further study how the different coral species respond to environmental stressors, including increased temperature. The hope is that those that demonstrate temperature resiliency and the ability to adapt to higher temperatures are propagated in those tanks then returned to the reef.

In Florida, scientists are using a process called microfragmentation to repopulate reefs. Temperature-resilient corals are sliced into numerous small fragments. These fragments grow extremely quickly, over 10 times faster than normal, and, once they reach a certain size, are then transplanted back onto the reef. When transplanted adjacent to each other, these coral fragments will fuse together into one large colony. Researchers are targeting key reefs for repopulation, including reefs that have special ecological value, are commercially important (i.e., from a fisheries perspective), or are source reefs of larvae that can naturally repopulate other reefs down current.

And in Australia scientists are using "coral nurseries," both land-based and field-based, like the photo below, to grow coral fragments collected from wild populations. The nurseries are often started with "corals of opportunity;" fragments that have been broken off of the main coral colony by natural

disturbances, such as storms, and have little chance of surviving unless stabilized on a nursery structure. Small fragments can also be taken from intact wild “donor” colonies. When the corals have grown to a size large enough to have a good chance of survival, they are then “outplanted” – moved and secured – to the reef.



Photo source: <http://reefresilience.org/restoration/coral-populations/coral-gardening/field-based-nurseries/>

So, yes, who cares really will win.

How scientists in the Western and South Pacific are managing outbreaks of Crown of Thorn sea stars is another example. Both research divers and an ROV called [RangerBOT](#) have been used to cull Crown of Thorn sea stars when an outbreak occurs. RangerBOT has become particularly effective; it uses image recognition to identify the sea stars with a 99.4% accuracy then injects them with ox bile – poisonous to them but not to the other reef organisms.

Another example is Dr. Shirley Pomponi, a researcher at Florida Atlantic University’s Harbor Branch Oceanographic Institute, who has spent her career hunting sponges – or, rather, collecting small samples of sponges to search for chemical compounds that could be important in fighting cancers and infections.

In all her years of studying sponges, Dr. Pomponi has never found a tumor in one of them. However, she has found several chemicals that fight infections in humans; a potential cure for cancer may not be far behind. Over the last 40 years, more than 30,000 new chemicals with unique properties that could have pharmaceutical importance have been discovered in microbes, algae, sponges, bryozoans, and other marine species. The organisms evolved these chemicals naturally and use them to defend against predators, communicate with their neighbors, or prevent algae and other encrusting species from growing on top of them.

So add the medical uses of sponges and other reef organisms to the list of reasons to curb the catastrophic climb of climate change. In the words of Dr. Pomponi, “We want to avoid a situation where the environment is damaged and some unique animal that produces a chemical that could cure cancer or other dreaded diseases is destroyed. If these remarkable sea creatures aren’t protected, who knows what we’ll lose.”

c. Maintaining Healthy Waterways Part II: Delaware River and Bay

When we left the South Fork of the Holston River in Kingsport, Tennessee in June 2019, we didn’t leave the notion that maintaining healthy waterways is key to the survival of benthic organisms and other species, including our own. Coincidentally, one of the research teams that conducted the water quality analysis and habitat surveys of the Holston River hails from the Academy of Natural Sciences at Drexel University, which is located in downtown Philadelphia, about 20 miles from Villanova University.

Drexel scientists also monitor waterways closer to home, including the Delaware River. One organism that has gotten their attention is the American eel, pictured below, a migratory species that spawns in the Atlantic, but spends most of its life in streams, rivers, estuaries, and lakes. This commercially and ecologically significant species was facing a population decline, mainly from the construction of dams – the operative word being *was*. Dams drastically limited their migration routes from the ocean to upstream freshwater areas, until scientists – from Drexel University and beyond – stepped in to help the eels on their journey. They built “eel ways,” which are similar to fish ladders but designed to help the eels maneuver over the dams. They also built traps to collect the eels downstream then transport them upstream, above the dam, where the eels were released to continue on their way.

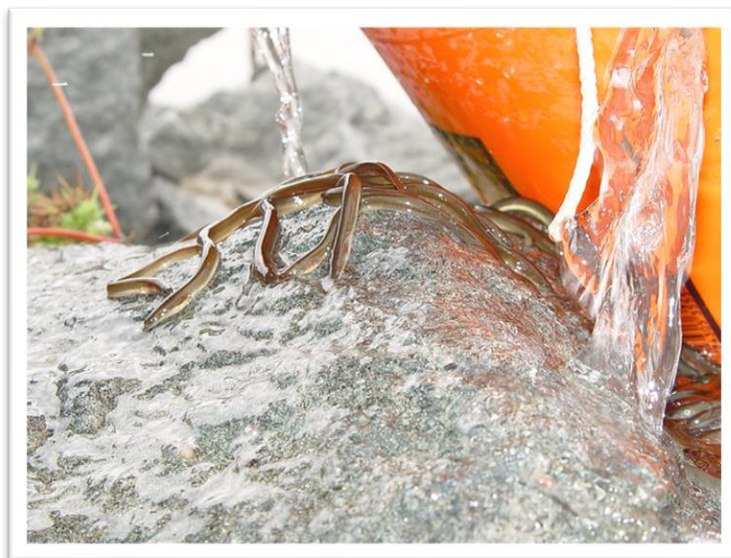

Photo source: <https://usfwsnortheast.files.wordpress.com/2014/06/american-eel.jpg>

Will Who Cares Really Win?

This assistance benefitted more than just the eels – and illustrates the interconnectedness of an ecosystem. Larval mussels need to attach to the gills of a fish or other organisms in order to complete their life cycle. Some mussel species specifically need American eels to survive. With fewer eels headed upstream, mussel larvae had fewer hosts to help them survive. And, in turn, fewer mussels meant poorer water quality because mussels have the ability to filter liters of water a day. So, saving one species helped to save the entire river ecosystem.

Yes, who cares really will win.

Another example are the scientists and researchers from the Delaware River Basin Commission (DRBC) who monitor the Delaware River, and its tributaries, as well as Delaware Bay – all pictured below. Their biological monitoring program looks at the diversity of macroinvertebrates throughout the watershed. They also monitor levels of toxic chemicals and heavy metals. In 2010, the Delaware River ranked fifth in the nation for highest amount of total toxic discharges. Today, because of the efforts of organizations like the DRBC, the clean-up of the Delaware is hailed as one of the world's top water quality success stories. The river now supports year-round fish populations, as well as those returning to their “birthplace” to spawn.



Photo source: <https://www.state.nj.us/drbc/basin/>

Another example is the Delaware Reef Program, which is part of a comprehensive fisheries management effort and designed to enhance fisheries habitat, benefit structure-oriented fish, and provide fishing opportunities for anglers. Over the long haul, artificial reefs are seen as a salvation for depleted or endangered fisheries.

The program began in 1995 and, to date, has 14 artificial reef sites in Delaware Bay and along the Atlantic Coast, including the Redbird Reef site, which takes its name from the "Redbird" paint-schemed subway cars donated in 2001 by New York City's Metropolitan Transportation Authority. To build the Redbird Reef, 619 of the obsolete subway cars were sunk, each of them 51 feet long by nine wide, making a substantial bottom structure for an artificial reef.

They went to the bottom just in time, too – Delaware got that bounty of subway cars after other states rejected their use as artificial reef material. Now, with Delaware's success in establishing "luxury condominiums for fish," like the one pictured below, other states are tenaciously competing for the old cars. For example, New Jersey, which was among the opponents of placing using them as artificial reefs, now has requested 600 subway cars from New York City.

As the old saying goes, “one person’s trash becomes another’s treasure.” Reduce, reuse, REPURPOSE.

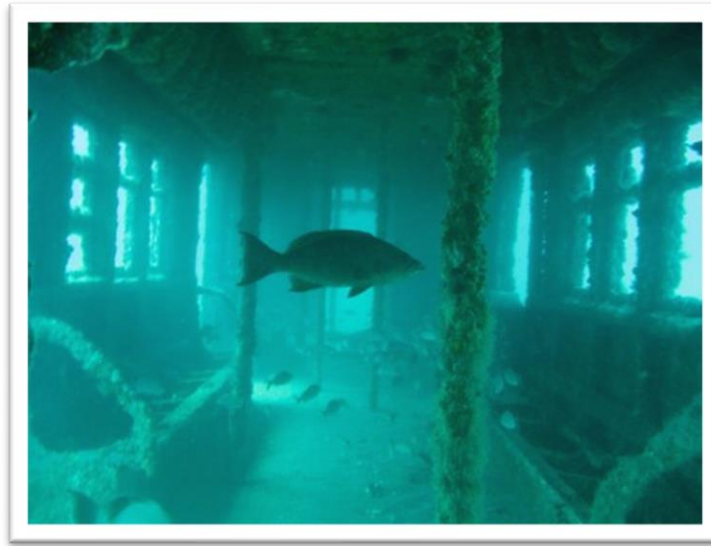

Photo source:

https://68.media.tumblr.com/bf053d69113a2d11d62532af312ef53d/tumblr_nxdh1sRpP01u2hca8o1_500.jpg

THIS IS WHERE YOUR MISSION BEGINS.

d. Mission Scope and Purpose

This and the following sections contain the technical specifications and requirements for ROV services needed to support Eastman. In 2021, ROV services include:

1) THE UBIQUITOUS PROBLEM OF PLASTIC POLLUTION

- Disconnect the power to a Seabin
- Replace an old mesh catch bag on the Seabin with a new one
- Reconnect the power to a Seabin
- Remove floating plastic debris from the surface
- Remove a ghost net from midwater
- Remove plastic debris from the bottom

2) THE CATASTROPHIC IMPACT OF CLIMATE CHANGE ON CORAL REEFS

- Fly a transect line over a coral reef
- Map points of interest on the reef
- Determine the health of a coral colony by comparing its current condition to past data
- Remove coral fragments from the nursery structure
- Outplant coral fragments into the reef
- Cull an outbreak of Crown of Thorn sea stars

- Collect samples of sponge species for pharmaceutical research

3) MAINTAINING HEALTHY WATERWAYS PART II: DELAWARE RIVER AND BAY

- Deploy a device into the pipe to collect a sediment sample
- Determine the type of contaminants present in the sediment sample
- Deploy a quadrat to estimate the number of mussels in a mussel bed
- Estimate the total amount of water filtered by the mussel bed
- Remove a trap full of eels
- Place an empty eel trap in the designated area
- Create a photomosaic of a subway car submerged to create an artificial reef

2. Specifications

See the specific tasks described below as well as the **PART 3: VEHICLE DESIGN & BUILDING SPECIFICATIONS** and **PART 4: COMPETITION RULES** sections.

3. Maintenance and Technical Support

The company shall warrant the ROV and associated systems and equipment for at least the duration of the product demonstrations. Repair or replacement shall be at the company's expense, including the cost of shipping the ROV to and from the competition facility.

During regional events, the company shall provide at least one day of technical support to resolve hardware, software, and operational issues. They shall provide at least three days of the same for the world championship event.

4. Shipping and Storage

Refer to [Shipping Information](#) for specifics on shipping to the MATE World Championship site.

Delivery of the ROV and associated systems and equipment shall be no later than the date of the geographically closest regional contest or by the first day of the MATE World Championship (date coming soon).

5. Evaluation Criteria

- a. Technical documentation
- b. Engineering presentation
- c. Marketing display
- d. Company spec sheet
- e. Product demonstration
- f. Safety

6. References

a. GENERAL

- <https://www.forbes.com/sites/georgkell/2018/07/11/the-remarkable-rise-of-esg/#69fbf2881695>
- [https://www.unglobalcompact.org/docs/issues_doc/Financial markets/who cares who wins.pdf](https://www.unglobalcompact.org/docs/issues_doc/Financial%20markets/who%20cares%20who%20wins.pdf)
- <https://sustainabledevelopment.un.org/?menu=1300>
- <https://www.ellenmacarthurfoundation.org/>
- <http://www.stephense.com/research/papers/oceans08.pdf>

b. THE UBIQUITOUS PROBLEM OF PLASTIC POLLUTION

- <https://www.nationalgeographic.org/encyclopedia/great-pacific-garbage-patch/>
- <https://www.youtube.com/watch?v=3RLrTCVmlCc>
- <https://theoceancleanup.com/great-pacific-garbage-patch/>
- <https://www.sciencenews.org/article/plastics-outnumber-baby-fish-some-coastal-nurseries>
- <https://www.pnas.org/content/early/2019/11/05/1907496116>
- https://i.kinja-img.com/gawker-media/image/upload/s--Vg9gBDua--/c_scale,fl_progressive,q_80,w_800/fb9osojkxv5r9qb5l8kv.jpg
- <https://seabinproject.com/>
- <https://www.youtube.com/watch?v=ySp7HKD7jaw>
- <https://wtkr.com/2018/10/11/first-seabin-on-the-east-coast-placed-near-nautilus/>
- <https://www.weforum.org/agenda/2019/06/underwater-robots-have-found-microplastics-from-the-surface-to-the-seafloor/>
- <https://www.washingtonpost.com/science/2019/05/15/he-went-where-no-human-had-gone-before-our-trash-had-already-beat-him-there/>

c. THE CATASTROPHIC IMPACT OF CLIMATE CHANGE ON CORAL REEFS

- <https://allencoralatlas.org/>
- <https://www.aims.gov.au/documents/30301/e4a579c7-6cb9-4484-ac9d-bd4526dd191a>
- <https://www.nrdc.org/stories/scientists-are-battling-mysterious-pathogen-destroying-coral-reefs-floridas-coast>
- <https://www.wbur.org/hereandnow/2019/11/18/hawaii-coral-reef-bleaching-study>
- <https://www.hawaiipublicradio.org/post/corals-are-adapting-higher-temperatures-likely-not-fast-enough#stream/0>
- <https://www.hawaiipublicradio.org/post/marine-scientists-track-coral-bleaching-real-time#stream/0>
- https://oceanservice.noaa.gov/facts/coral_bleach.html
- <https://newatlas.com/rangerbot-reef-underwater-drone/56173/>
- <https://newatlas.com/larvalbot-larvae-robot-great-barrier-reef/56966>
- <https://newatlas.com/larvalbot-replenish-great-barrier-reef/57666/>

- <http://reefresilience.org/restoration/coral-populations/coral-gardening/field-based-nurseries/>
- <http://reefresilience.org/restoration/coral-populations/coral-gardening/collecting-fragments/>
- <http://reefresilience.org/restoration/coral-populations/coral-gardening/outplanting/>
- https://en.wikipedia.org/wiki/Crown-of-thorns_starfish
- <https://www.oma.noaa.gov/find/media/images/removal-crown-thorns-sea-stars-during-outbreak>
- [Personal communications, National Marine Sanctuary American Samoa scientists](#)
- <https://www.ncbi.nlm.nih.gov/pmc/articles/PMC4325318/>
- <https://ocean.si.edu/ocean-life/invertebrates/five-questions-shirley-pomponi-medical-sponge-hunter>
- <https://www.ecowatch.com/coral-sponge-cancer-health-2540016583.html>

d. MAINTAINING HEALTHY WATERWAYS PART II: DELAWARE RIVER AND BAY

- <https://ansp.org/research/environmental-research/projects/watershed-protection-program/>
- <https://www.state.nj.us/drbc/basin/>
- <https://www.state.nj.us/drbc/quality/>
- http://www.buckslocalnews.com/news/environmental-group-delaware-river-tops-list-of-most-polluted-waterways/article_b94c90d5-a5c1-5c8e-b39d-2319fa2a511a.html
- https://www.state.nj.us/drbc/library/documents/Yagecic_water-quality-monitoring_sept2017.pdf
- <http://www.inphotonics.com/raman.htm>
- <https://usfwsnortheast.wordpress.com/2017/08/21/mussels-making-moves-for-water-quality/>
- <https://usfwsnortheast.wordpress.com/2017/09/08/restoring-rivers-with-a-little-mussel-power/>
- <https://usfwsnortheast.wordpress.com/2014/06/20/bringing-back-american-eels-in-the-susquehanna-river/>
- <http://www.dnrec.delaware.gov/fw/Fisheries/Pages/ArtificialReefProgram.aspx>
- <https://archive.epa.gov/reg3esd1/archive/web/html/reefs.html>

IMPORTANT NOTE: Questions about production demonstrations and design and building specifications must be posted to the competition FAQs board located at <http://forums.marinetech2.org/index.php>. This allows all companies to see the questions and answers and helps to avoid duplicate questions. That said, please make sure that your question(s) has not already been asked – and answered – before posting. It is up to the companies to read, comprehend, and comply with ALL rulings posted on the FAQ board.

SIZE AND WEIGHT RESTRICTIONS

In light of some of the environments in which the ROVs will be operating, an ROV size and weight requirement has been included in the request for proposals (RFP). Smaller, lighter vehicles will be given special consideration and vehicles above a certain size and weight will not be considered.

All size and weight measurements will include the vehicle, all tools and components (including the device used to retrieve the sediment sample from inside the drain pipe, even if it is detachable from the ROV), and the tether. The following will NOT be included in the length or weight measurement:

- The topside control system and 1 meter of tether going into the control system
- Any independent sensors if removable from the ROV
- Non-ROV device to power the Seabin if removable from the ROV
- Quadrat for estimating the number of mussels

Vehicles will be measured and weighed in the EXPLORER on-deck circle 15 to 20 minutes prior to the company's product demonstration run. Note that the vehicle will be measured and weighed before each product demonstration run. The size and weight bonus, if any, will be added to each product demonstration score.

2021 size and weight parameters

Size measurements will be made using the two largest dimensions of the ROV. Three rings with diameters of 64 cm, 75 cm, and 92 cm will be located on a table in the on deck circle. Companies will place their vehicles on the table and, when ready, ask a MATE ROV Competition official to make the size measurement. The vehicle measurement must include the vehicle and all manipulators/tools that will be used in the product demonstration as well as the vehicle's tether. Any removable sensors, Seabin power devices, and quadrat constructed by the company will not be included in size and weight. The control system and 1 meter of tether may be outside of the measurement circle.

Hand powered lifts and levers and tether management systems may be used with the vehicle. Hand powered lifts and levers will not count towards the size or weight of the ROV. Tether management systems that can be separated from the vehicle will not count towards the size or weight of the ROV.

Companies may detach manipulator arms and other equipment and place that equipment, next to, on top of, or inside the vehicle frame, but all of the equipment that will be used must be present and fit within the measurement circle. For example, a company may remove a manipulator arm that extends 20 cm in front of the vehicle and place it on top of the vehicle. The measurement will be made with the arm on top of the vehicle provided that the length and width are still the largest diameters.

The size rings will be placed over the two largest dimensions of the ROV.

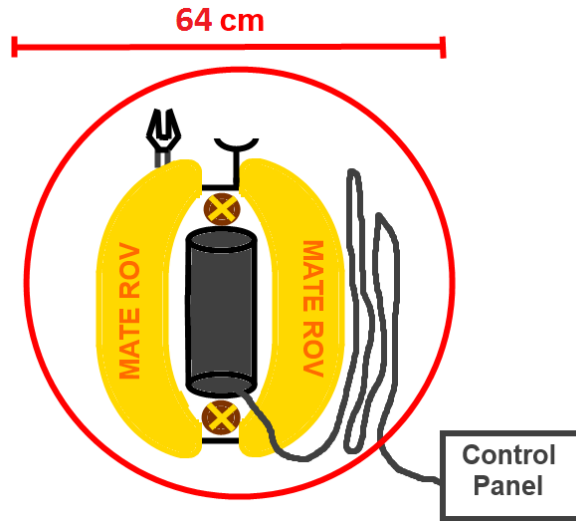

An EXPLORER vehicle, with tools attached and tether coiled beside the ROV, inside the 60 cm diameter ring. This vehicle would earn the company +10 bonus points on the product demonstration score.

Weight measurements will be conducted using a digital scale. In addition, companies must be able to personally transport the vehicle and associated equipment to the product demonstration station and to the engineering presentation room. ROV systems must be capable of being safely hand launched.

Competition officials will use the following chart to award points for size and weight:

Size		Weight (in air)	
< 64 cm diameter	+10 points	< 20 kg	+10 points
64.1 cm to 75 cm	+5 points	20.01 kg to 28 kg	+5 points
75.1 cm to 92 cm	+0 points	28.01 kg to 35 kg	+0 points

Vehicles above 92 cm in diameter, or greater than 35 kg in weight, will not be allowed to compete in the product demonstration.

Size and Weight Protocol

Only the six designated product demonstration company members will be allowed into the on-deck circle during and after the measurement and weigh in. Once a company's vehicle has been measured and weighed, it must remain there until the company moves to its product demonstration station. Companies that detach equipment from the vehicle may not re-install that equipment until the 5-minute set up period. At that time, companies may replace any items that were detached for the measurement, but no new equipment (i.e., equipment that was not included in the size and weight measurements) may be added to the vehicle. If it is discovered that a company added equipment that was not included in the measurements, the company will not be permitted to compete in that product demonstration run.

Videos showing simulated size and weight measurements are posted [here](#).

PRODUCT DEMONSTRATION

TASK 1: THE UBIQUITOUS PROBLEM OF PLASTIC POLLUTION

This task involves the following steps:

1.1 Seabin – “Cleaning up our ocean one marina at a time”

- Disconnecting the old power connector to the recently installed Seabin – 5 points
- Removing a previously installed Seabin’s mesh catch bag – 10 points
- Installing a new mesh catch bag into the Seabin – 10 points
- Reconnecting a new power connector to the recently installed Seabin – 20 points

1.2 Remediation: Removing plastic pollution from top to bottom

- Removing floating plastic debris from the surface
 - Removing all 6 pieces of debris – 15 points
 - Removing 3 to 5 pieces of debris – 10 points
 - Removing 1 to 2 pieces of debris – 5 points
 - Removing 0 pieces of debris – 0 points
- Removing a ghost net from midwater
 - Pulling a pin to simulate cutting the ghost net free – 10 points
 - Removing the ghost net from the water – 10 points
- Removing plastic debris from the bottom of the Mariana Trench – 5 points each, 10 points total

Total points = 90 points

Product Demonstration Notes:

Companies must do the steps of the Seabin – “Cleaning up our ocean one marina at a time” task in order. Companies may not skip any steps of the Seabin task. Companies may complete the steps of Remediation: Removing plastic pollution from top to bottom in any order.

Task 1.1 Seabin – “Cleaning up our ocean one marina at a time”

Companies must conduct maintenance on a Seabin recently deployed in open water. The body of the Seabin will be constructed from a 5-gallon bucket. A ½-inch PVC framework will be secured inside the bucket approximately 5 cm from the top. The mesh catch bag will be simulated by [mesh netting](#) attached to a framework of ½-inch PVC pipe. The framework of the catch bag will sit on the ½-inch PVC framework secured inside the open top of the bucket. The power port for powering the Seabin will be attached to a ½-inch PVC framework on the outside of the 5-gallon bucket. The Seabin will be attached to a weight on the bottom by a length of rope.

Companies must first disconnect the old power connector from the port on the Seabin. The connector will be constructed from 2-inch PVC pipe. A ½-inch PVC pipe handle will act as a grab point on the 2-inch connector. The transmitter side of a 12-volt [inductive coupling power connector](#) will be located at the other end of the 2-inch pipe, in a 2-inch knockout cap and covered with less than 2 mm of epoxy for

waterproofing. Wires will connect the inductive coupling transmitter side to a 12 volt supply on the surface.

The power port will be constructed from 3-inch pipe and will be attached to the ½-inch framework on the outside of the Seabin. The receiver side of the inductive coupling power connector will be placed in the bottom, center of the power port and covered with less than 2 mm of epoxy for waterproofing. Wires will connect the receiver to waterproofed LEDs attached to the outside of the power port.

Companies must first disconnect the old power connector from the port on the Seabin. At the start of the product demonstration, the old power connector will be in the power port and the LEDs will be illuminated. Companies must remove the power connector from the port. Companies that successfully disconnect the old power connector will receive 5 points. Successfully disconnecting the old power connector is defined as the power connector under control of the ROV, the LEDs on the port no longer illuminated, and the connector no long in contact with the power port or the Seabin. Once successfully disconnected, the old connector will be considered debris. To avoid penalty points for leaving debris in the water, companies must keep the connector secured in a gripper on their ROV or return it to the surface.

Once successfully disconnected, companies may pull the connector out of the water by hand. Note: The ROV must first remove the power connector from the power port. Companies cannot pull the power connector from the power port by hand. The connector must be released from the ROV before it is pulled up by hand; companies cannot bring the ROV to the surface by pulling on the connector. Companies that are unable to remove the power connector cannot continue with the Seabin task.

The old power connector will weigh less than 5 Newtons in water.

Once the power to the Seabin has been disconnected, companies must remove the old mesh catch bag and install a new one. Both the old and new mesh catch bag will be identical in construction, but the old mesh catch bag will contain plastic debris. The mesh catch bags will be constructed of mesh netting attached to a framework of ½-inch PVC pipe. The PVC pipe framework of the mesh catch bag will rest inside the top of and on the PVC framework inside the Seabin. A PVC handle will act as grab points for the mesh. The PVC handle will extend above the top opening of the 5-gallon bucket.

Companies must first remove the old mesh catch bag from the inside the Seabin. The Seabin will be attached to a line that will be anchored to the bottom of the pool by a weight. The Seabin will be buoyant, floating mid-water. The top of the 5-gallon bucket will be 30 cm to 50 cm below the surface of the water. Companies will receive 10 points when the old mesh catch bag is successfully removed. Successful removal of the old mesh catch bag is defined as the old bag removed from the water and placed on the pool deck.

Once the old mesh catch bag has been removed from the Seabin, companies must install the new mesh catch bag. The new mesh catch bag will be located at the surface, side of the pool during the product demonstration set up time. Companies will receive 10 points for successfully installing the new mesh catch bag. Successfully installing the new mesh catch bag is defined as the mesh catch bag no longer in

contact with the ROV, and the ½-inch PVC framework of the mesh catch bag completely inside and resting flat on the PVC framework secured inside the Seabin.

Note that companies must remove the old mesh catch bag from the Seabin before installing the new one, but companies do not have to return the old mesh catch bag to the surface before installing the new one. For example, companies could remove the old mesh catch bag and hold it in a gripper or set it on the bottom. Companies could then install the new mesh catch bag. Then companies could return the old mesh catch bag to the surface, side of the pool.

Mesh catch bags will weigh less than 5 Newtons in water.

Once the new mesh catch bag has been installed, power must be restored to the Seabin. If the new mesh catch bag has not been installed, companies may not attempt to reconnect the power connector. Companies are tasked with designing and creating their own functional power connector to insert into the 3-inch pipe of the power port. The company-built power connector must meet the following specifications:

- Body is 15 cm or more in length
- Body is 5 cm or greater in diameter or width
- Incorporates a waterproofed transmitter side of an inductive coupling power connector

Companies will be tasked with designing and building the transmitter side of the inductive coupling power connector that is capable of providing 12 volts to the receiver side. The powered connector will be considered a [3.3.1 Non-ROV Device Power Specifications](#); companies must follow the Non-ROV device power specifications to provide power to their connector. Companies powering their non-ROV device from the surface may plug their connector directly into a 12V power supply provided by the MATE ROV Competition or provide their own power source. Connection to the 12V MATE supply will be via red/black [Anderson powerpole connectors](#).

See [3.2.3 Tether length, MECH-003E](#) for the length of cable needed to reach the Seabin.

Companies will receive 20 points for successfully reconnecting the power to the Seabin. Successfully reconnecting the power is defined as illuminating the LEDs on the power port. The station judge must be able to see the illuminated LEDs. The connector must remain inside the port, with the LEDs illuminated for the entire mission run. If the connector falls or is knocked out of the port, or the LEDs are no longer illuminated, the company will lose points for the task, but may try to re-install the connector to re-illuminate the LEDs.

Additional information on the Seabin and the inductive coupling power connector will be provided in the [Prop Building Instructions](#).

Task 1.2 Remediation: Removing plastic pollution from top to bottom

Companies must remove floating plastic debris from the surface of the pool. Six ping-pong balls will be floating on the surface, contained within a 1 meter square ½-inch PVC framework. The framework will

be attached to the side of the pool by a length of ½-inch PVC pipe to keep it from drifting. Companies must remove the ping-pong balls (plastic debris) from the surface and return them to the side of the pool. Companies that successfully remove all six ping-pong balls will receive 15 points. Companies that successfully remove only 3 to 5 ping-pong balls will receive 10 points. Companies that successfully remove only 1 or 2 ping-pong balls will receive 5 points. Successfully removing the plastics debris from the water is defined as the ping-pong balls being removed from the framework under control of the ROV and placed on the pool deck.

Each ping-pong ball will have less than 5 Newtons of buoyant force in water.

Companies must remove a ghost net from midwater. The net will be constructed from ½-inch PVC pipe and [decorative cloth netting](#) will be attached to the framework with cable ties. The net will be located midwater in the pool. The net will be positively buoyant, and secured to a weight on the bottom by a rope. Companies must pull a pin to simulate cutting the rope and releasing the net from the weight on the bottom. Companies will receive 10 points when they successfully pull the pin. Successfully pulling the pin is defined as the pin no longer in contact with the PVC pipe or netting of the ghost net. After pulling the pin, companies must return it to the surface.

Once companies have pulled the pin, they must return the ghost net to the surface, side of the pool. Companies will receive 10 points when they successfully remove the ghost net from the water. Successfully removing the ghost net is defined as the PVC pipe and netting as well as the pin completely out of the water and placed on the pool deck. The weight and rope holding the net do not need to be removed from the pool.

The ghost net will have less than 5 Newtons of buoyant force in water.

Companies must remove plastic debris from the bottom. The plastic debris on the bottom will consist of two 1-gallon plastic Ziploc bags. ½-inch PVC pipe inside the bag will provide weight to keep the bag from drifting. The PVC pipe will be secured to the inside of the Ziploc bag with industrial strength Velcro. The Ziploc bag will be open at the top, allowing it to fill with water; it will not contain air bubbles. Companies must remove this plastic debris from the bottom and return it to the side of the pool. Companies will receive 5 points for each bag successfully removed from the water, 10 points total. Successfully removing the debris from the water is defined as placing it on the pool deck.

The Ziploc bag and PVC will weigh less than 5 Newtons in water.

TASK 2: THE CATASTROPHIC IMPACT OF CLIMATE CHANGE ON CORAL REEFS

This task involves the following steps:

- 2.1 Flying a transect line over a coral reef and mapping points of interest**
 - **Flying a transect line over a coral reef**
 - **Flying the transect autonomously – 15 points**
 - **Flying the transect manually – 5 points**

- **Mapping points of interest on the reef**
 - **Autonomous mapping on a video display – 10 points**
 - **Manual mapping on a video display – 5 points**

2.2 Using image recognition to determine the health of a coral colony by comparing its current condition to past data

- **Using image recognition to determine the health of the coral colony**
 - **All areas of change successfully identified – 20 points**
 - **At least one, but not all, areas of change successfully identified – 10 points**
 - **No areas of change successfully identified – 0 points**
- **Using a handbook to determine the health of the coral colony – 5 points**

2.3 Propagating corals onto the reef

- **Removing coral fragments from the nursery structure – 5 points each, 10 points total**
- **Outplanting coral fragments to designated locations on the reef – 5 points each, 10 points total**

2.4 Culling an outbreak of Crown of Thorn sea stars – 5 points each, 10 points total

2.5 Collecting samples of sponge species for pharmaceutical research

- **Collecting a sample of the sponge – 10 points**
- **Returning the sample to the surface – 5 points**

Total points = 90 points

Product Demonstration Notes:

Companies may complete the steps of Task 2: The Catastrophic Impact of Climate Change on Coral Reefs in any order.

Task 2.1 Flying a transect line over a coral reef and mapping points of interest

Companies must fly a transect line over a coral reef. The coral reef will be simulated by a ½-inch PVC pipe rectangle 3 meters long by 1 meter wide. A grid of 27 squares, 33 cm per side, will be created within this rectangle using [Pink Braided Nylon Mason’s Line](#). The 3-meter lengths of PVC pipe that make up the “top” and “bottom” of the reef will be painted blue.

The 1-meter “ends” of the coral reef will be divided into three 33 cm sections. The middle 33 cm section will be painted black, while the two outer sections will be painted yellow.

An additional 3-meter length of PVC pipe will be located 50 cm from the top and bottom of the reef. These additional lengths of pipe will be painted red. The coral reef area will be located on the bottom of the pool.

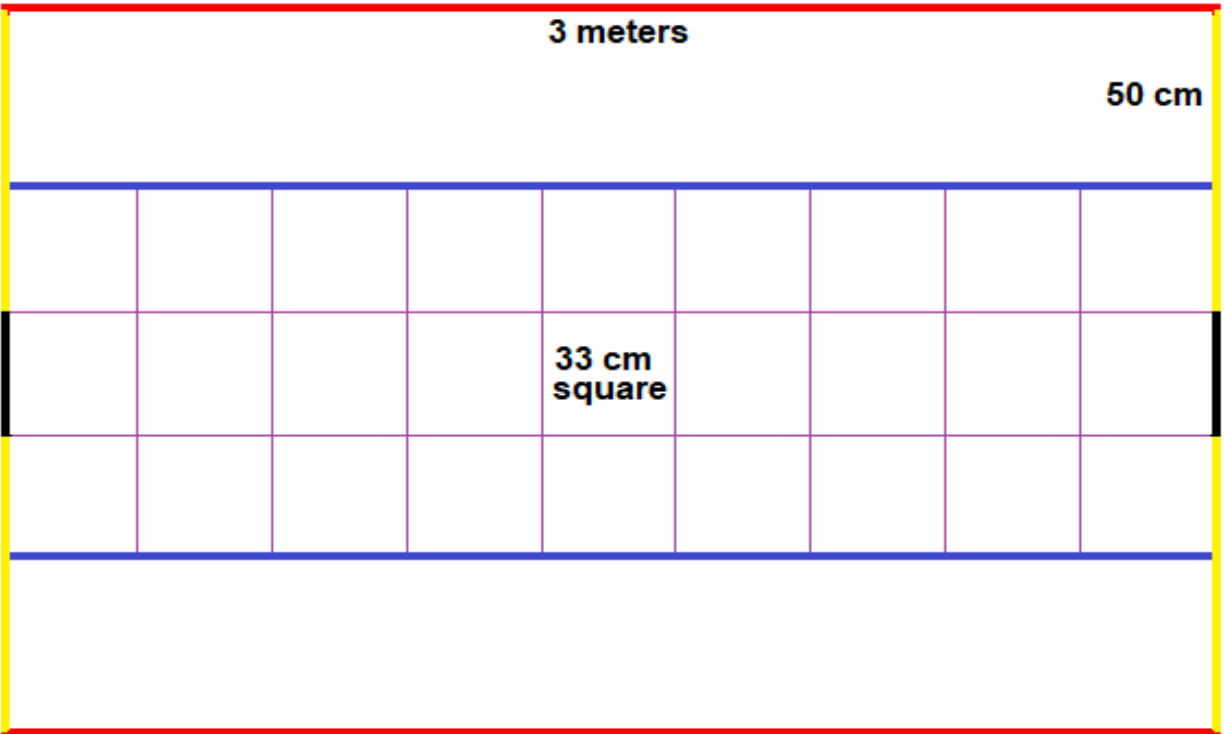

A diagram of the coral reef. The blue, red, yellow, and black lines are painted ½-inch PVC pipes. The purple lines are braided Mason’s Line.

Companies must fly a transect line over the coral reef, displaying the video image of the transect on a display screen for the station judge. Successfully flying a transect over the coral reef is defined as starting at one end of the transect and moving to the other end of the transect. Starting at one end of the transect is defined as the ROV directly above the black length of PVC pipe on either end of the coral reef.

The ROV must also remain at a certain height over the reef during the transect. While flying the transect over the coral reef, both blue painted PVC pipes must be in the video display at all times and neither red line may be visible in the video display. If any section of red pipe is seen in the video display, or both blue pipes are not seen in the video display at all times, the ROV has failed to successfully fly the transect.

A video showing successful and unsuccessful flying of the transect line can be seen [here](#).

Companies are tasked with creating software that will allow their vehicle to autonomously fly a transect line over the coral reef. Companies that successfully fly a transect over the coral reef using an autonomous control program will receive 15 points. Successfully flying the transect line autonomously is defined as the control program moving the vehicle from one end of the transect to the other without any input from the company members. No company member should be touching the controls or other systems for the entire flight of the transect. A tether manager may hold the tether, but cannot guide the vehicle in any way. The station judge must be able to see the vehicle moving through the water and must be able to see both blue PVC pipes but neither of the red pipes in the video display at all times. If

the vehicle fails to autonomously fly the transect, companies may reposition their vehicle at one end of the coral reef, above a black painted length of PVC, and try again. Either end of the coral reef may be used as the starting point for the transect. There is no limit to how many times the company may try to autonomously fly the transect. Companies that cannot successfully autonomously fly the transect line may attempt to fly the transect manually. Companies should inform the station judge if they decide to do so.

Alternatively, companies may attempt to fly the transect manually. Companies may pilot their vehicle to move over the coral reef from one end to the other. Companies that successfully fly the transect line manually will receive 5 points. Successfully flying the transect line manually is defined as the vehicle, under control of the pilot, moving from one end of the transect to the other. The station judge must be able to see the vehicle moving through the water and must be able to see both blue PVC pipes but neither of the red pipes in the video display at all times during the flight of the transect. If the vehicle fails to fly the transect, companies may reposition their vehicle at one end of the coral reef, above a black painted length of PVC, and try again. Either end of the coral reef may be the starting point for the transect. There is no limit to how many times the company may try to manually fly the transect.

Companies must also map points of interest on the coral reef. There will be six points of interest located within the coral reef. These points of interest are related to the other steps of Task 2. Descriptions of the items will be detailed with those tasks. The six points of interest are:

- One larger coral colony (occupying two adjacent squares)
- Two designated areas for outplanting coral fragments
- Two crown of thorn sea stars
- One sponge

Companies are tasked with creating software to autonomously map the locations of the points of interest on the grid system. Companies should design a display with 27 squares. The squares should be arranged in a nine x three grid copying the orientation of the coral reef grid in the pool. The software must autonomously overlay a colored circle in the proper square for each point of interest (the larger coral will encompass two squares and each square should be marked). The two adjacent squares containing the larger coral colony should each be overlaid with a red circle. The two squares containing designated areas for outplanting coral fragments should each be overlaid with a yellow circle. The two squares containing the Crown of Thorn sea stars should each be overlaid with a blue circle. The square containing the sponge should be overlaid with a green circle. Companies will receive 10 points for successfully mapping the location of the points of interest autonomously on their video display map. Successfully mapping the locations is defined as all circles appearing in the proper grid squares with no input from the company. Companies may use two circles or one oval (elongated circle) to overlay the coral colony that occupies two squares. The station judge must see the circle overlays. Companies may inform the judge that the overlays have appeared, but should not touch the control station while doing so. Companies not able to autonomously map the points of interest may not retry this task, but may still map the points of interest manually. Companies should inform the station judge if they decide to map manually.

The intent for autonomous mapping is to develop a software program that uses a photo / video screenshot image of the actual points of interests on the reef then creates a map of grid squares and places those points of interest in the appropriate grid squares autonomously. The map of grid squares presented to the judges for scoring cannot be a screenshot of the coral reef on the bottom of the pool. Companies may take a screenshot of the bottom of the pool and transfer that image to another device, but the map of grid squares must be an independent image, not a copy of the screenshot. Companies may not manipulate the screenshot before transferring it to another device to autonomously create the map. Companies may not manually designate a portion of their video display for their screenshot (i.e., cannot manually circle the upper right portion of the screen for their program to focus on) before transferring the image to another device. Companies may pilot their vehicle to any location to take the image, and may manually transfer that image to another device, but companies may not make any changes to the image manually. Any manual manipulation of the image before transferring it to another device would be considered manual mapping the points of interest.

Alternatively, companies may choose to manually map the locations of the points of interest on the grid system. Manually marking the locations on the map must still be done on a video display screen, but company members may use a program to physically draw colored circles on the grid. Companies should design a display with 27 squares. The squares should be arranged in a nine x three grid copying the orientation of the coral reef grid in the pool. Circles can be manually overlaid into the proper squares for each point of interest (the larger coral will encompass two squares and each square should be marked). The two adjacent squares containing the larger coral colony should each be overlaid with a red circle. The two squares containing designated areas for outplanting coral fragments should each be overlaid with a yellow circle. The two squares containing the Crown of Thorn sea stars should each be overlaid with a blue circle. The square containing the sponge should be overlaid with a green circle. Companies will receive 5 points for successfully mapping the location of the points of interest on their video display map. Successfully mapping the locations is defined as all circles appearing in the proper grid squares. Companies may use two circles or one oval (elongated circle) to overlay the coral colony that occupies two squares. Companies only get one opportunity to manually map the six points of interest. Companies that cannot successfully create the map manually will not receive points for mapping.

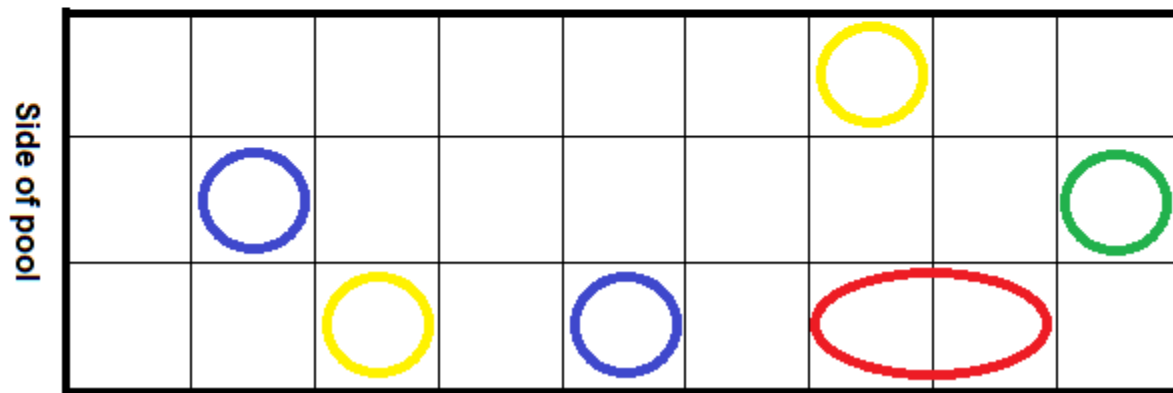
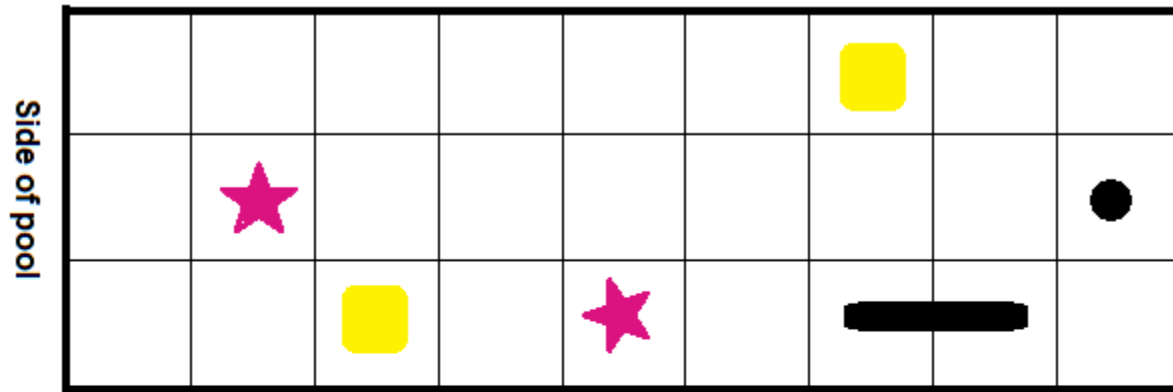

Top: Reef with coral colony, two locations for outplanting coral fragments, two sea stars, and a sponge.
 Bottom: Colored circle overlays in the proper squares to match the organisms on the reef.

For both autonomous and manual mapping of the points of interest, the grid map should identify the orientation of the map, i.e., which edge is closest to the side of the pool.

Mapping the points of interest is separate from flying the transect line. Companies may choose to do the two tasks simultaneously or may choose to do the two tasks individually.

Task 2.2 Using image recognition to determine the health of a coral colony by comparing its current condition to past data

A large coral colony will be located in the reef. The coral colony will be constructed from ½-inch PVC pipe. The base of the coral will be located in two squares in the coral reef grid. Companies must determine the health of the coral colony by comparing the current image to an image taken one year ago. Companies must compare images to assess whether the coral has grown, is damaged/has died, is bleached/blotched, or has recovered from bleaching/blotching. Growth is defined as the coral colony having new [pink](#) branches not seen in the previous image. Damage or death is defined as the coral colony missing branches that were seen in the previous image. Coral bleaching or blotching is defined as pink colored branches from the previous photo having turned white. Recovery from bleaching or blotching is defined as white branches from the previous photo now being colored pink.

Companies must compare the current coral colony to the previous image and show any changes on a video display. The base of the coral will be painted black, will not change shape or color, and should not be used in the image comparisons.

Companies may develop image recognition software to identify and display the areas of change on the coral colony to the station judge. On a video screen, the company's program should outline areas where the coral has changed. The following parameters must be used:

- Areas of growth should be outlined with a green overlay or a marked with a green rectangle/circle around the affected area.
- Areas of damage or death should be outlined with a yellow overlay or marked with a yellow rectangle/circle around the affected area.
- Areas of bleaching/blotching should be outlined with a red overlay or marked with a red rectangle/circle around the affected area.
- Areas that have recovered from bleaching/blotching should be outlined with a blue overlay or marked with a blue rectangle/circle around the affected area.

Every coral colony will have two to four areas of change, but only one or two categories of change. For example, a coral colony may have two areas of growth, and one area of recovery from bleaching and blotching (three areas of change, but only two categories of change). Or a coral colony may have four instances of bleaching/blotching (4 areas of change, but only one category of change).

Once the image recognition program has identified the areas of change, companies must show their display, outlining the areas of change, to the station judge. Companies that successfully outline all areas of change using image recognition will receive 20 points. Companies that successfully outline at least one area of change, but do not outline all the areas of change, will receive 10 points. Successfully outlining an area is defined as the area of change overlaid with the proper color for the type of change.

Companies may drive their vehicle to any position to get the coral colony correctly positioned on their video screen. Depending on which side of the coral your ROV is positioned, the image may be a mirror image of the coral colony from 1 year prior. Companies may choose to work with the mirror image or reposition their vehicle.

Companies using image recognition may not define the image area on their screen for their program to examine. Nor may companies take a screenshot of the coral colony, transfer it to another screen/device to have that device implement the image recognition. Companies should position their vehicle where they can see the coral and have their image recognition program identify areas of change. Companies may not move, or remove, items from the product demonstration area to get a clearer image of the coral colony.

A "before" [photo of the coral colony](#) will be provided to all companies. This photo will represent the image of the coral colony from one year ago. Companies using image recognition may use this photo to construct their own "before" coral colony to compare the current coral colony.

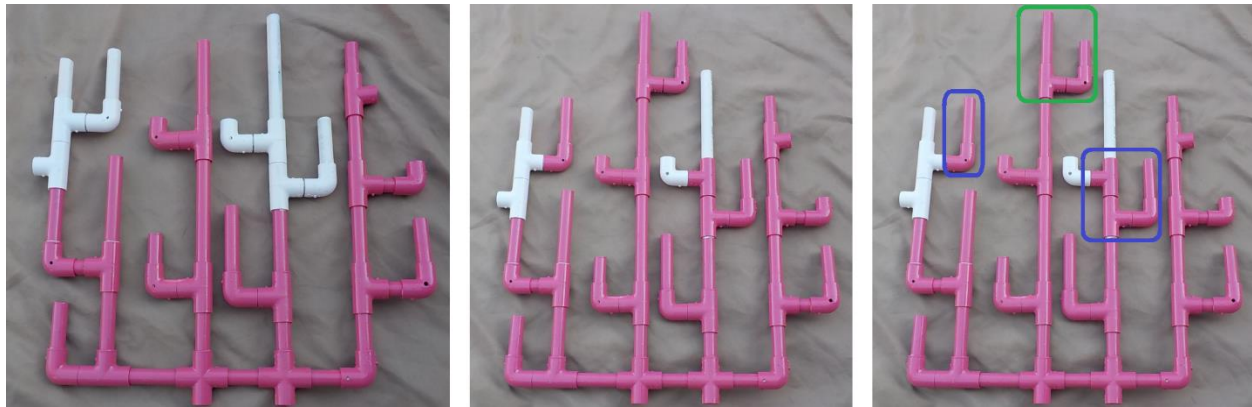

Left: The coral colony photo from 1 year prior.

Center: The coral colony as it is today.

Right: The coral colony with all areas of change identified. There is one area of growth, and two areas of recovery from bleaching/blotching.

Alternatively, companies may determine the health of the coral colony by manually comparing the current image to an image taken of the coral colony one year ago using the photo of the coral colony from one year prior. An image of the coral colony taken one year ago will be available at the product demonstration station. Companies will receive 5 points when they successfully determine the health of the coral colony by manually comparing the current image to the image from one year ago. Successfully determining the health of the coral colony manually is defined as outlining all areas of change on the coral colony photo from one year prior to the station judge and informing the judge what type of change has taken place. The company member informing the judge of the type of change should use the terms growth, death or damage, bleaching/blotching, or recovery from bleaching/blotching.

Task 2.3 Propagating corals onto the reef

Companies must propagate corals onto the reef. Coral fragments will be constructed from ½-inch PVC pipe. A 3/8-inch-16, 3-inch bolt will be attached inside the ½-inch pipe of the coral fragment. Four coral fragments will be located on a nursery structure. The nursery structure will be constructed from ½-inch PVC pipe. The coral fragments will sit upright on the nursery structure, with the 3/8-inch bolt sitting loosely in an upright section of ½-inch pipe on the nursery structure. Companies must remove two coral fragments from the ½-inch pipe of the nursery structure. Companies will receive 5 points for each coral fragment successfully removed from the structure, 10 points maximum. Successfully removing a coral fragment from the nursery structure is defined as the ½-inch pipe and 3/8-inch bolt under control of the ROV and no longer in contact with the ½-inch pipe of the nursery structure. Companies will not get additional points for removing more than two coral fragments from the nursery structure.

Coral fragments will weigh less than 5 Newtons in water.

Once the coral fragments have been removed from the nursery structure, they must be outplanted onto the coral reef. Two designated areas will be located within the coral reef area. Designated areas will be constructed from a ½-inch PVC pipe framework covered with a yellow-colored corrugated plastic sheet. A section of 1-inch PVC pipe will rise vertically from the designated area. Companies must insert the

coral fragment into the 1-inch PVC pipe. Companies will receive 5 points for successfully outplanting each coral fragment, 10 points total. Successfully outplanting a coral is defined as the 3/8-inch bolt of the coral fragment positioned inside the vertical 1-inch pipe and the PVC pipe of the coral fragment in contact with the vertical 1-inch pipe of the designated area. The coral fragment(s) must remain successfully outplanted into the designated area for the entire product demonstration run. If the coral fragment is displaced from the designated area at any time during the product demonstration run, the company will not receive points for successfully outplanting the coral fragment. If a coral fragment is displaced from the designated area, companies may attempt to outplant the coral fragment again. Companies may try outplanting the same coral fragment, or may retrieve a different coral fragment from the nursery structure and outplant that fragment.

Task 2.4 Culling an outbreak of Crown of Thorn sea stars

Companies must also cull an outbreak of Crown of Thorn sea stars. Two Crown of Thorn sea stars will be located in the coral reef area. Sea stars will be constructed from ½-inch PVC pipe. Sea stars are culled by injecting them with ox bile. For the purposes of the product demonstration, the ox bile injection will be simulated by a Velcro to Velcro stick. A 5 cm x 5 cm square of Velcro loops will be attached to the center of each sea star. Companies must attach an injection device of Velcro hooks to the Velcro loops on the Crown of Thorn sea stars.

The MATE ROV Competition will provide two injection devices of Velcro hooks at each product demonstration station. These devices provided by the competition will be a 4 cm x 4 cm square of Velcro hooks attached to a ½-inch end cap. The end cap will have a length of rope attached to it as a grab point. However, companies may construct and use their own sea star injection devices of Velcro hooks. Company created Velcro hook must not exceed 6 cm x 6 cm square, should be large enough for the judge to determine that it has been attached to the sea star, and should be black in color. The station judge must be able to see the Velcro hooks attached to the Velcro loops on the sea star. Any additional objects attached to the Velcro hooks should not obscure the judge's view of the Velcro connection.

Companies will receive 5 points when they successfully inject each Crown of Thorn sea star, 10 points total. Successfully injecting the Crown of Thorns sea star is defined as the Velcro hooks on the injection device attached to the Velcro loops on the sea star. The Velcro hooks must remain attached to the sea star for 10 seconds after being released by the ROV. If the hooks fall off the sea star, companies may try again.

Each MATE Competition injection device will weigh less than 5 Newtons in water.

Task 2.5 Collecting samples of sponge species for pharmaceutical research

Companies must also collect samples of sponge species for pharmaceutical research. The sponge will be constructed from three 2-inch couplings, with weight inside, stacked on top of each other. A length of green tape around the middle of each coupling will help it to stand out from the pool bottom. Companies are required to collect only the top most coupling. The remainder of the sponge, i.e., the bottom two couplings, must remain on the pool bottom and cannot be knocked over.

Companies will receive 10 points when the top coupling of the sponge is successfully removed from the stack. Successfully removing the top coupling is defined as the uppermost 2-inch coupling under control of the ROV and no longer in contact with the two couplings on the pool bottom. The two couplings on the pool bottom must remain stacked on top of each other for the entire product demonstration run. If at any time the remaining stack is knocked over, companies will not receive the points for collecting the sample of the sponge.

Once the sponge sample is collected, companies may return the sponge sample to the surface. Companies will receive 5 points when they successfully return the sponge sample to the surface, side of the pool. Companies that do not receive points for collecting the sponge due to knocking over the stack, may still receive points for returning the sample to the surface, side of the pool.

With weight, the sponge sample will weigh less than 5 Newtons in water.

Companies may not destroy or knock over any portion of the coral reef area. Companies that knock over the remaining portion of the sponge sample will not get points for collecting the sponge. Companies that displace coral fragments from the designated locations will not receive points unless those coral fragments are replaced before the product demonstration time expires. Companies that knock over the large coral colony, or drag it from its location on the reef, will be penalized 5 points. At the end of the product demonstration period, the station judge will examine the coral reef area to determine if any items have been disturbed or displaced. The station judge will confirm with the company whether points are removed or penalized due to disturbing or displacing objects in the coral reef area.

TASK 3: MAINTAINING HEALTHY WATERWAYS II: DELAWARE RIVER AND BAY

This task involves the following steps:

- 3.1 Retrieving a sediment sample from inside a drain pipe to analyze for contaminants**
 - Deploying a device into the pipe to collect a sediment sample – 25 points
 - Returning the sample to the surface – 10 points
 - Determining the type of contaminant(s) present in the sediment sample – 5 points
- 3.2 Estimating the number of mussels in a mussel bed**
 - Deploying a quadrat and counting the number of mussels in the quadrat – 5 points
 - Estimating the number of mussels and the total amount of water filtered by the mussel bed – 5 points
- 3.3 Eel restoration**
 - Removing a trap full of eels from a designated area – 10 points
 - Placing an empty eel trap in a designated area – 10 points
- 3.4 Creating a photomosaic of a subway car submerged to create an artificial reef**
 - Autonomously– 20 points
 - Manually– 10 points

Total points = 90 points

Product Demonstration Notes:

Companies may complete the steps of Task 3: Maintaining Healthy Waterways II: Delaware River and Bay in any order.

Task 3.1 Retrieving a sediment sample from inside a drain pipe to analyze for contaminants

Companies will be required to retrieve a sediment sample from the end of a drain pipe and determine the type of contaminant(s) present in the sample. The drain pipe will be no longer than 3.2 meters and constructed from [6-inch Corex drain pipe](#). The Corex drain pipe will rest on the bottom of the pool and will not curve. The far end of the pipe will be covered. The drain pipe will be weighted down.

The sediment sample will be constructed from 1-inch PVC pipe with two 1-inch end caps attached to each end. Holes will be drilled in the pipe and the end caps to allow water into the pipe. A 32-cm length of rope will act as a grab point for the sediment sample. The 1-inch pipe will be covered with [white industrial strength Velcro loops](#). The sediment sample will be located at the far end of the drain pipe.

The sediment sample will weigh less than 5 Newtons in water.

Companies may build and deploy a secondary (micro-ROV) from their primary ROV or develop and build another device to retrieve the sample from the end of the drain pipe. A micro-ROV will be considered a non-ROV device. See [3.3.1 Non-ROV Device Power Specifications](#) for additional information.

Companies will receive 25 points when the sediment sample is successfully removed from the 6-inch pipe. Successfully removing the sediment sample from the pipe is defined as the 1-inch pipe of the sediment sample completely outside of the 6-inch Corex drain pipe. The micro-ROV or other device must move into the drain pipe and remove the sample. The Corex drain pipe cannot be lifted, shaken, or otherwise moved or manipulated to cause the sediment sample to fall or roll out of the open end.

Companies should be prepared for low light levels inside the Corex drain pipe.

Once the sediment sample has been removed from the drain pipe, it must be returned to the surface. Companies will receive 10 points when they successfully remove the sediment sample from the pool. Successfully removing the sediment sample is defined as returning the sample to the surface, side of the pool and placing it on the pool deck.

Once the sediment sample is at the surface, companies can retrieve the sediment's Raman spectrum.* In this case, the spectrum will be printed on a laminated sheet and rolled up inside the 1-inch pipe of the sediment sample. Companies must compare the sample's spectrum to a chart of peaks and sub peaks of known chemical contaminants. A copy of the chart will be available at the product demonstration station. Companies must evaluate the spectrum and the chart to determine what type of contaminant(s) are present in the sediment. Companies will receive 5 points when they successfully determine the contaminant(s) present in the sediment. Successfully determining the contaminant(s) is defined as showing the station judge which chemical contaminant(s) from the chart match the peaks

and sub peaks of the spectrum retrieved in the sediment sample. The spectrum will contain peaks and sub peaks for one or two chemical contaminants.

*Note: Raman spectroscopy is commonly used in chemistry to determine the chemical composition of an object or substance. It can identify and quantify molecules and produce a chemical “fingerprint” of that object or substance. The chemical fingerprint, also known as the spectrum, is generated when the scattered Raman photons pass into a detector where they are broken into their respective wavelengths and plotted. For more information about Raman spectroscopy, see the REFERENCE section of the competition manual.

In Raman spectroscopy, diamonds are used as reference peaks in spectra from unknown sources. The spectrum will have a diamond spike for reference purposes.

<u>Chemical contaminant</u>	<u>Main Peak (cm⁻¹)</u>	<u>Sub Peak(s) (cm⁻¹)</u>
Arsenic Sulfide	385	420
Cadmium Sulfide	520 – 540	
Copper Oxide	297	
Diamond	1332	
Lead	1054	
Mercury	547	435
Polyflouroalkyl	1560 to 1580	1325
PCBs	1590	1575

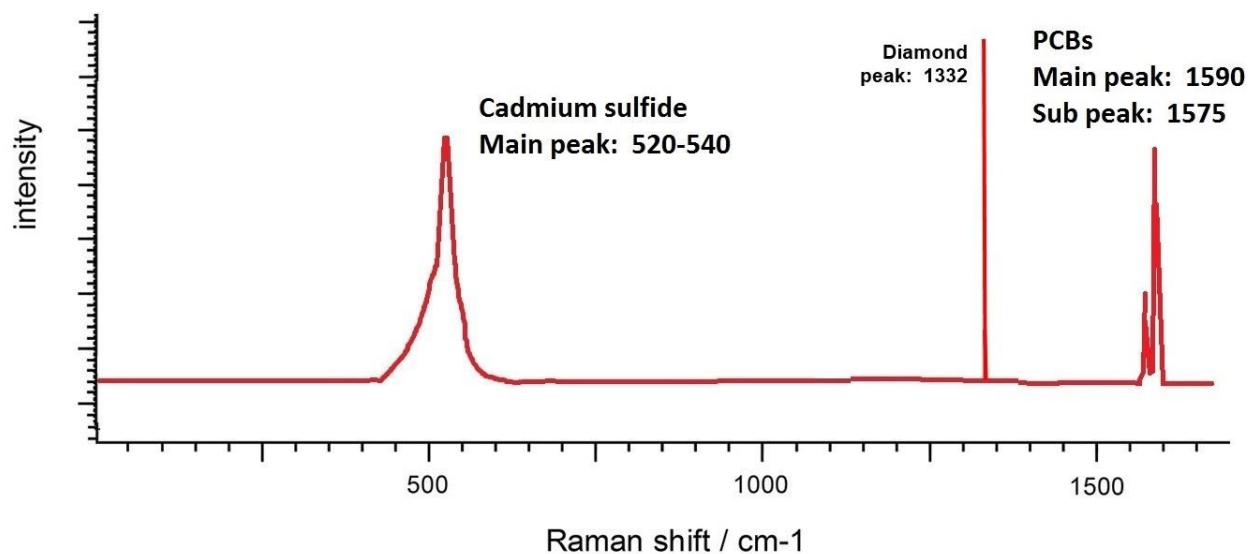

Raman spectrum of sediment contaminated with CdS (520-540 cm⁻¹) and PCBs (1590 and 1575). Note the diamond peak (1332 cm⁻¹).

Task 3.2 Estimating the number of mussels in a mussel bed

Companies must estimate the number of mussels in a mussel bed. The area of the mussel bed will be constructed from a square of corrugated plastic approximately 1.2 m x 1.2 m attached to a PVC

framework. The mussel bed will lay flat against the bottom of the pool. Small, painted plastic disks will simulate the mussels. Companies are required to create their own 0.5 meter x 0.5 meter quadrat and place it on mussel bed. The inner dimensions of the quadrat **MUST** be 50 cm x 50 cm square. Companies that do not have a quadrat within 1 cm of those dimensions will not be able to complete the task. All edges of the quadrat must be completely on the corrugated plastic of the mussel bed. No portion of the quadrat may rest over the side of the corrugated plastic sheet. Companies that do not successfully deploy their quadrat may try again, but once the quadrat is successfully placed, it should not be moved (i.e. repositioned to get a different mussel count). The quadrat, if separate from the ROV, must be carried down by the ROV. The company built quadrat is not considered debris. Companies will not be penalized for leaving their quadrat in the pool at the end of mission time and, if asked, divers can retrieve the quadrat and return it to the company without penalty after the mission time ends.

Once the quadrat has been deployed, companies must count the number of mussels inside the quadrat. Companies must show the product demonstration station judge the quadrat and report the mussels within that quadrat. Companies should count every mussel that has any part of its "shell" inside the dimensions of the quadrat. For example, if only a small section of the plastic disk (mussel shell) shows inside the quadrat, it still should be counted. Companies will receive 5 points when they successfully count the number of mussels inside the quadrat and inform the station judge of that number. Successfully counting the number of mussels in the quadrat is defined as counting the same number of mussels in the quadrat as the station judge.

Companies receive one chance to count the mussels; if the company count is incorrect (i.e., not the same as the judge's count), companies will receive 0 points for counting the mussels. If the count is incorrect, the mission station judge will inform the team they are incorrect and share the actual count of mussels in the quadrat.

When the company has counted the number of mussels within the quadrat, the station judge will provide the company with the dimensions of the mussel bed and the average filtration rate of the mussels. Companies should assume the mussel bed is rectangular. The dimensions given will be length and width (in meters) of the bed. Filtration rate of the mussels will be given in liters per hour. Companies must first use their mussel count and the area of the mussel bed to estimate the total number of mussels in the bed. Companies will receive 5 points for successfully estimating the number of mussels in the bed and the total amount of water filtered by the mussel bed every hour. A successful estimation of the number of mussels in the bed is defined as the total number of mussels being within 1 mussel of the actual count. A successful calculation of the total amount of water filtered by the mussel bed is defined as the total amount within 1 liter of the actual amount. Companies must report their total number to the station judge.

For example, if the overall size of the mussel bed is 43 meters by 8 meters, and the company counted 7 mussels in their 50 cm x 50 cm quadrat, the total number of mussels in the bed is 9,632. If the filtration rate of a single mussel is 0.97 liters per hour, the total amount of water filtered by the mussel bed in one hour is 9,343.04 liters.

Task 3.3 Eel restoration

Companies must remove a trap full of eels and replace it with an empty trap to aid in eel restoration. Both eel traps will be identical. The framework for the eel trap will be constructed from ½-inch PVC pipe. Plastic mesh will surround the framework. A #310 U-bolt will act as a grab point for the eel trap. At the start of the product demonstration run, a trap with eels in it will be located in a designated area on the pool bottom. Another, empty trap will be located on the surface, side of the pool.

Eels will be simulated by 1-inch PVC pipe. The designated area will be constructed from ½-inch PVC pipe.

Companies must remove the trap full of eels from the bottom and return it to the surface, side of the pool. Companies will receive 10 points for successfully removing the trap. Successfully removing the trap full of eels is defined as removing the trap from the water and placing it on the pool deck.

Companies must place the empty eel trap in the designated area on the bottom. Companies will receive 10 points for successfully placing the trap in the designated area. Successfully placing the trap is defined as the trap no longer in contact with the ROV, upright, and completely within the designated area. No portion of the trap may be sitting on top of any part of the designated area.

Both the full and the empty eel trap will weigh less than 5 Newtons in water.

Task 3.4 Creating a photomosaic of a subway car submerged to create an artificial reef

Companies must create a photomosaic of the four sides and top of the subway car submerged to create the artificial reef. The framework for the subway car will be constructed from ½-inch PVC pipe. Corrugated plastic sheets will be attached to the four sides and to the top of the PVC framework. The simulated subway car will be approximately 120 cm long, 60 cm wide, and 60 cm tall. A length of colored tape will run along each edge, a different color for every edge. Companies may use this colored tape to assist in matching up the sides for the photomosaic.

Companies must take an image of each side of the subway car and an image of its top. These images must be “stitched” together showing all four sides in a row with the colored tape matching on each edge. The image of the top of the subway car must be “stitched” to the long edge (120 cm edge) of one side of the subway car.

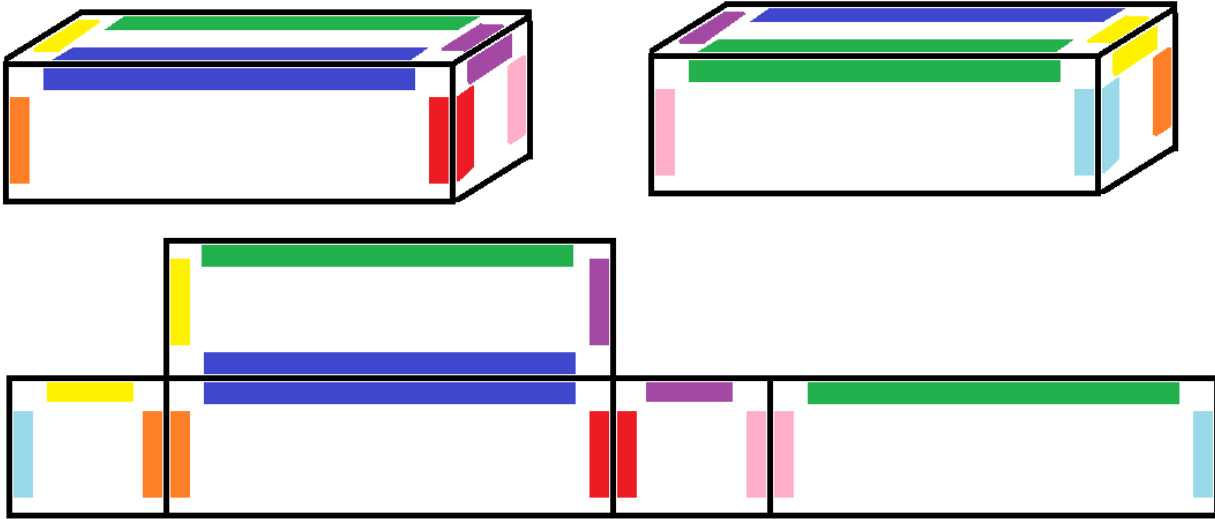

Top: Diagram of color matching on subway car.

Bottom: Photomosaic of the subway car to be displayed on video screen. Note: Colors may vary, but each subway car will have eight distinct colors on the eight edges.

Companies are tasked with creating software to autonomously “stitch” the images together into a photomosaic. Companies may manually pilot their vehicle to any location to take images of the four sides and top of the subway car, but the program must “stitch” the images into a photomosaic. Companies that successfully “stitch” the images together autonomously will receive 20 points. Successfully “stitching” the images together autonomously is defined as no input from company members other than taking the images. The photomosaic must be compiled and shown to the station judge within the 15-minute product demonstration period. Pilots may drive their vehicle to any location to position the sides and top of the subway car for their camera. Companies may transfer the five images to another device (e.g., a laptop computer or tablet) at the product demonstration to have that device “stitch” the images together. Companies may not transfer the images to anyone not at the product demonstration station; doing so will result in disqualification. **All work must be done by company members or devices at the product demonstration station.** Companies transferring images to another device should inform the station judge of their intended actions.

Alternatively, companies may create the photomosaic of the subway car manually. Companies that successfully “stitch” the images together manually will receive 10 points. Successfully “stitching” the images together manually is defined as a company member at the product demonstration station using a program to physically cut and paste the images into a photomosaic. Art programs such as Photoshop, MSPaint, or others can be used. This photomosaic must be compiled and shown to the station judge within the 15-minute product demonstration period. Pilots may drive their vehicle to any position to get the sides and top of the subway car positioned for their camera.

Companies attempting to create the photomosaic of the submerged subway car autonomously are permitted to take screenshots of the sides of the subway car and manually transfer them to another device. How a company takes their image, what images are taken, and how the images are transferred to the device is up to the company. The images cannot be manipulated prior to being transferred to the

device that is stitching them together autonomously. Companies may pilot their vehicle to any location to take a photo, but once taken that photo must be transferred unaltered. Any manipulation of a photo would be considered manual creation of the photomosaic. Minor obstructions (ROV tool, frame) in the photos are allowed, provided the station judge can identify the subway car and color combinations in the final photomosaic.

Once transferred to a device, a software program should then autonomously join the photos into a photomosaic matching the colored edges of each side of the subway car. The program should match the colors on the side of the subway cars; using the order the photos are taken / delivered to the program is not considered autonomous.

An image of the subway car photomosaic will be available in the product demonstration prop building instructions & photos document. The color combinations will be different at each mission station, but the colors on one side (top) will always match the color on the adjoining side. Colored, not white, tape will always be used.

Time bonus:

If a company has successfully completed all product demonstration tasks and is returning to the surface with the Seabin mesh catch bag, plastic debris, the ghost net, the sponge, or the full eel trap, the product demonstration time will stop when a member of the company touches the vehicle. The mesh catch bag, plastic debris, the ghost net, the sponge, or the full eel trap onboard may be detached and set on the pool deck after the clock has stopped. If any of these items is subsequently dropped from the vehicle and sink to the bottom, the company will not receive points for returning the item to the surface, time will not restart, and the company will not receive a time bonus.

PRODUCT DEMONSTRATION RESOURCES

The [EXPLORER Coral Colony photo](#) will show an image of the coral colony taken one year prior.

The [EXPLORER Raman spectrum chart](#) notes the peaks and sub-peaks of various chemical contaminants.

NOTE for 2021!!!

PRODUCT DEMONSTRATION RESPONSIBILITIES

Companies must provide their own new power connector for the recently installed Seabin. Companies are responsible for providing their own device to retrieve the sediment sample from inside the drain pipe. Companies must also provide their own quadrat for counting mussels. The MATE ROV Competition will provide sea star injection devices, but companies may design and bring their own versions. Companies must also design and bring any tools or devices to complete the required MATE product demonstration tasks.

Companies are permitted to create a basket to collect multiple product demonstration items. Any collection basket MUST be included in size and weight measurements. A collection basket is considered

debris if still in the pool and not under control of the ROV when product demonstration time ends. Any collection basket must be deployed and returned by the ROV; it may not be pulled to the surface by hand or a surface device.

The MATE ROV Competition will provide all of the remaining product demonstration items.

PART 2: PRODUCT DEMONSTRATION PROP BUILDING INSTRUCTIONS & PHOTOS

The [Product Demonstration Prop Building Instructions & Photos](#) and photos have been made their own, separate document. This document will be released with, but separate from, this competition manual.

PART 3: VEHICLE DESIGN & BUILDING SPECIFICATIONS

1.0 GENERAL

Questions about vehicle design and building specifications, as well as competition rules, should be posted to Competition Help within the MATE Forum Hub (<http://forums.marinetech2.org/>). This ensures that all companies can view the questions and answers and helps to avoid duplicate questions. That said, companies should make sure that their questions have not already been asked – and answered – before posting. When posting their question, companies should reference the specific specification (e.g. ELEC-002E).

Conventions: All values contained in this document are threshold values unless specifically stated otherwise. All water depths are given in meters (m). All dimensions and measurements utilize SI units.

EXPLORER class companies participating in a regional competition should contact [your regional coordinator or visit your regional contest's website](#) to find out any specific requirements for your regional.

2.0 SAFETY

Safety is the competition's primary concern and guiding principle. Any system that is deemed unsafe by competition officials will not be allowed to compete. If a safety concern is identified during the initial inspection, companies are permitted to modify their system and have it re-inspected. Companies are permitted to have their vehicle re-inspected twice. If a company fails to pass its third and final safety inspection, it is disqualified from the underwater competition portion of the event. There are NO APPEALS once an ROV has been disqualified.

Examples of safety violations from previous ROV competitions include:

- Companies used equipment that did not participate in and/or pass safety inspection
- The electrical SID included in the technical documentation did not show a main fuse.

- The ROV used pneumatics, but the technical documentation did not include a pneumatics diagram.
- The ROV used pneumatics, but the company had not passed the fluid power quiz.

2.1 Job Site Safety Analysis

Each member of the company is encouraged to read [Oceaneering Americas Region HSE Employee Handbook](#), with emphasis placed on the following chapters.

Chapter 1 - Housekeeping

Chapter 9 - Hand Safety

Chapter 11 - Lifting and back safety

Chapter 12 - PPE

Chapter 17 - Tool Safety

Chapter 24 Electrical Safety

Chapter 29 - Employee Observation Program

Chapter 33 - JSEA

Chapter 37 - Working at Other sights

Job Site Safety Analysis (JSAs)

For companies advancing to the world championship, up to 10 additional points can be earned by creating a JSA and submitting it along with (but as a separate document from) the [Technical Documentation](#).

A **JSA** describes job tasks in step-by-step fashion, identifies associated hazards at each step, and outlines proper hazard controls that minimize the risk of injury or illness to the individual(s) performing that task. JSAs are used extensively by the offshore industry.

For more information and examples, companies can visit the following web sites:

- <http://ehs.berkeley.edu/how-do-i-write-and-update-job-safety-analysis-ja>
- www.safetyworksmaine.com/safe_workplace/safety_management/hazard_analysis.html

POTENTIAL HAZARDS

DESCRIBE JOB STEP <small>(List the natural steps of the job. Do not make the steps too broad or too fine)</small>	POTENTIAL HAZARDS <small>(What are the potential hazards identified at this part of the job steps)</small>	RECOMMEND RISK CONTROL MEASURES <small>(describe how the identified hazards can be eliminated or reduced)</small>	RESPONSIBLE PERSON (S) <small>(implementing control)</small>	INITIAL <small>(Of the responsible person/s)</small>
Toolbox Talk	Miscommunication	<p>ANYONE can call ALL STOP at any point if an unsafe condition /act is perceived/observed.</p> <p>Cell phone use is PROHIBITED in test area while testing!</p> <p>Ensure all participants are aware of procedures and roles within the procedure and sign JSEA acknowledging thusly.</p> <p>Ensure that all participants are wearing correct PPE (safety glasses, safety shoes, gloves, and hard hats if crane ops are being performed)</p> <p>Ensure participants/witnesses are wearing adequate clothing for weather conditions and to take breaks whenever necessary.</p>		
Hydraulic Function Testing	<p>Stored/Trapped Energy: Up to 12,000 PSI</p> <p>Environmental Discharge</p> <p>Tubing/Hose Failure</p> <p>Line of Fire</p>	<p>Ensure all functions have pressure/flow reduced to 0 PSI when not being actively function tested.</p> <p>Ensure each circuit is setup correctly before increasing pressure.</p> <p>Ensure Vent hoses are properly connected to fluid containment reservoir.</p> <p>Ensure all hoses are whip checked before coming up on pressure.</p> <p>Ensure valves and actuators are in proper configuration before testing.</p> <p>Ensure relief valves are set to relieve at the proper setting.</p>		

Example JSA task items courtesy of Oceaneering International

NOTE for 2021!!!

Companies should focus their JSA on their deck/dive operations only. Shop safety and tool safety for building the ROV is important, but does not belong in this JSA. The submitted JSA should focus information on potential hazards and recommended risk control measures of a company’s pool side operations. This JSA should cover topics such as:

Deck Ops/Launch and Recovery:

- Entering/exiting the pool deck area
- System set up
- Power up checks
- Pool side operations
- System break down

2.2 Safety Pre-Inspection

A safety pre-inspection will be completed before competition day. Companies will submit the following documentation to the MATE ROV Competition. EXPLORER teams attending regionals should submit their required documentation to their regional coordinator. Regionals may not require all of these documents. Contact [your regional coordinator or visit your regional contest’s website](#) to determine the

required documents as well as the date and proper format for submission. Safety pre-inspection document submissions will include the following:

- Technical documentation
- Company spec sheet
- SID [Electrical, Pneumatic & Hydraulic as utilized]
- Non-ROV device design document
- Non-ROV device SIDs
- Company safety review

See 2.2.1 Safety documentation requirements below for more information.

Once received, safety inspectors will conduct an **initial safety and documentation review** to identify potential safety violations. This review will be worth 20 points. Companies with violations will be notified via e-mail. Once notified, companies must:

- a. Respond acknowledging receipt.
- b. Layout a plan to address the violation.
- c. Submit new documentation if required.

Safety inspectors will also compile a list of the safety violations and publish them to the competition web site. This is not done to “call out” or embarrass companies in any way. It is to emphasize the fact that EVERYONE is responsible and accountable for ensuring a safe, successful event. It also allows the company to correct the safety violations before arriving at the world championship.

2.2.1 Safety documentation requirements

Unless stated otherwise, each document MUST be submitted separately. In addition to the SID included in the technical documentation, an individual SID must be submitted for the initial safety inspection. The company safety review should not refer to systems shown in a submission video or detailed in the technical documentation.

DOC-001: SID Electrical: This must be an electrical diagram for all ROV systems. One section should focus on the systems above the waterline, and one section should focus on systems on the ROV (below the waterline). The SID:

- Should not exceed one 8.5” x 11” page in length (both above and below water sections, as well as any other information, should be on one page). Printed documents must be sized to fit on one side of the printed paper.

- Must be drawn with a CAD (computer assisted drawing) program. Hand drawn figures are not permitted.
- All symbols used should be standard symbols as specified by ANSI, NEMA or IEC.
- The SID must include a FUSE SYMBOL using an ANSI, NEMA or IEC symbol.
- The SID must not be component level schematics, but a higher level interconnection block type diagram. Do not include individual pins on a board; the SID is a higher level diagram.
- Fuse calculations must be included on the SID.

The following ANSI and IEC fuse symbols are all acceptable for MATE documentation.

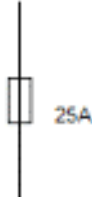
Item	ANSI	IEC
FUSE		

An example of an acceptable SID can be found here:

- EXPLORER example: [2018 Eastern Edge SID](#)

DOC-002: SID Fluid Power: Companies using fluid power **MUST** include a fluid power diagram using industry standard symbols, showing all items, regulators, and control valves. The diagram must document the components on the surface and the components located onboard the ROV. Fluid power diagrams must use ANSI, NEMA or IEC symbols. The fluid power diagram must also be drawn with a CAD program and should be a one 8.5" x 11" page diagram. The fluid power diagram may be included on the main electrical SID or as a separate one page document.

DOC-003: SID Non-ROV Device: Companies utilizing an independent sensor or other electrically powered, non-ROV device to complete a product demonstration task must submit a SID for this device. The power connector for the Seabin, if used, is a non-ROV device. A micro-ROV, if used, is a non-ROV device. Companies must include an SID for their power connector and their micro-ROV. This diagram must be completed to the specifications listed in DOC-001. The non-ROV device SID may be included on the main electrical SID or as a separate one 8.5" x 11" page document. Companies must include fuse calculations for the power connector and micro-ROV on their non-ROV device SID.

DOC-004: Non-ROV device Design: Companies will be required to submit a one page written and photographic description of their non-ROV device for retrieving the sediment sample from the drain pipe. This document must specify whether your device uses on board power or is powered from the primary ROV. If the device uses onboard batteries, you **MUST** include the type of battery used.

NOTE for 2021!!! Any electrical or fluid powered device on the ROV MUST be documented on a SID. Depending on the type of device, it may be on the main ROV SID, an independent sensor SID, a Non-ROV device SID, or a Fluid SID. Any such device not represented on a SID cannot be used in the competition.

DOC-005: Company safety review: EXPLORER companies submitting a company safety review MUST show compliance with the following specifications:

- SBS50 Anderson Powerpole connectors are the main point of connection to the MATE supply (ELEC-010E).
- A properly sized Littlefuse is within 30 cm of the main point of connection. The company must use a ruler to show this distance (ELEC-001E).
- Fuse calculations (ELEC-008E).
- The inside of the control box is does not have exposed wiring (ELEC-017E), the control box is neatly laid out with attention to workmanship (ELEC-022E), a separation and identification of 120VAC wiring from DC and control voltages (ELEC-023E). If AC wiring is not used in the control box, include a statement saying no AC is used.
- The tether leading to the ROV has proper strain relief (ELEC-024E).
- If hydraulics / pneumatics are used that the company has passed the Fluid Power Quiz (FLUID-014). If fluid power is not used on the vehicle, include a statement saying no fluid power is used.
- If used, hydraulic / pneumatic systems include a pressure release valve and regulator in the system (FLUID-007, FLUID-011), and that any pressurized cylinder, pressure storage device meets the MATE specifications (FLUID-012, FLUID-013).
- Any watertight housing on the vehicle can withstand pressure at 5 meters (MECH-001).
- All propellers are shrouded (MECH-006).
- The ROV has no sharp edges or elements of the ROV that could cause damage (MECH-006, ELEC-017R).

The following photographs **MUST** be included within the company safety review:

- Anderson Powerpole connector within 30 cm of Littlefuse (show fuse, ruler and connectors)
- Inside of the control box with wires labeled
- Strain relief where tether goes into ROV
- Compressor or pump (if pneumatics/hydraulics are used) including release valve and regulator
- Propeller shrouds (front and back of one propeller)

The company safety review should include an explanation of how each system meets the safety specifications and include photographs of the relevant systems for review by the MATE ROV Competition officials.

Initial Safety and Documentation Review points

Penalty points will be deducted from the initial safety and documentation review if:

- Companies do NOT submit ALL the required documentation by the given [date](#). See [6.2 KEY DEADLINES](#).

- The SID does not show a fuse, or the fuse does not use an ANSI, NEMA or IEC symbol.
- Fuse calculations are not show on the SID.
- The vehicle uses fluid power, but a fluid power diagram is not included.
- A non-ROV device is used but is not shown on any SID.
- The technical documentation is over 8MB in size.
- Other documents are over 2MB in size.
- The company safety review does not show compliance with all of the specifications.

The initial safety and documentation review rubric can be found [here](#).

2.3 Onsite Safety Inspection

Companies must complete their onsite safety inspection before their vehicles enter the water.

Companies advancing to the World Championship must complete their first on-site safety inspection prior to the opening ceremonies. Companies that cannot meet this deadline will undergo their first safety inspection check whether or not company members or the vehicle is present. Without a vehicle, the company will fail their safety inspection.

At the World Championship, companies MUST pass their safety inspection by the end of the first day of the competition. Companies that do not pass their safety inspection by the end of the first day will be disqualified from the underwater product demonstration component.

Companies must transport their vehicles to a designated room(s) where they will undergo their safety inspection. **NEW for 2021!!!** A power supply will be available; companies will power up their control system and vehicle during the safety inspection. The inspector(s) will reference the list of violations as he/she conducts the safety inspection of the vehicle using the safety inspection rubric.

What follows is the safety inspection protocol used at the world championship. Consult [your regional coordinator or visit your regional contest's website](#) for more information about the safety inspection process used at your regional.

2.4 Safety inspection protocol

1. Before entering the water for practice or a product demonstration run, the ROV system must go through a safety inspection. Once a company successfully passes inspection, they will turn in their safety inspection sheet to the safety inspector and receive a Blue PASSED Card with their company number on it. Companies must present the Blue PASSED Card to the pool practice/product demonstration coordinator before their vehicles are permitted to enter the water.
2. Competition staff will conduct a safety inspection of the vehicle using the [safety inspection rubric](#).

3. If the safety inspector(s) identify a safety violation, companies will have the opportunity to address it. The pool practice or product demonstration run schedule will NOT change to allow companies more time.
4. If during the second safety review the
 - a. violation has not been properly addressed or
 - b. another violation is revealedcompanies will have ONE additional opportunity to address the issue.
5. If during the third safety review a violation still exists, companies will not be permitted to participate in the underwater product demonstration component of the competition. However, companies can still participate in the engineering and communication (technical documentation, product presentation, and marketing display) component.
6. Reminder: All companies must present the Blue PASSED Card to the pool practice or product demonstration judge before placing their vehicles in the water. In addition, product demonstration station judges and competition officials can pause or stop a product demonstration run at any time if they feel that there is a potential safety concern.

REMINDER!!! Companies do not need to present their Blue PASSED Card to the judges during their engineering presentation. Companies that have their product presentations scheduled for the first day do not require an early safety inspection in order to participate in their presentation.

NOTE for 2021!!!

All items used on the ROV MUST participate in and pass safety inspection. Companies that use a device that did not participate in and pass the safety inspection will be disqualified.

2.5 Safety Inspection Points

The safety inspection is worth 30 points. Each time a company fails its safety inspection it loses 10 points. After a company fails its second inspection, it must meet with the chief safety inspector to discuss a plan of action prior to returning to its workstation. THREE STRIKES and a company

- a. Receives 0 points for the safety inspections and
- b. Is disqualified from the underwater product demonstration component

3.0 SPECIFICATIONS

The ROV system (or “system”) must meet the following requirements:

3.1 Operational

3.1.1 Multiple Vehicles

OPER-001: EXPLORER class companies are required to design and build ONE ROV that can complete the necessary product demonstration tasks. If companies choose to tackle the retrieving of the sediment sample from the drain pipe, a second, micro-ROV can be constructed. When not retrieving the sediment sample from the drain pipe, the micro-ROV must be attached to or docked with the main ROV or removed from the water. "Floating eyeballs" or other vehicles that are not hard connected to the frame of the main vehicle are NOT permitted. Cameras designed to provide a "birds-eye view" are permitted provided that these cameras are hard connected to the frame of the main vehicle. "Hard connection" does not include the wiring between the camera and the ROV. Other than the drain pipe task, the micro-ROV may not move away from the main ROV to provide an additional camera view.

3.1.2 Environmental

OPER-002: The ROV system must be able to function in fresh, chlorinated water with temperatures between 15°C and 30°C. The water should be considered conductive of electrical currents.

OPER-003: The pool will not be covered or purposefully darkened in any way, although the specific product demonstration tasks may require that your ROV operates in low-light.

OPER-004: No water currents will be intentionally created. Also, depending on the venue, pressurized pool filtration system outlets may cause unexpected currents.

OPER-005: The pool venue at the world championship has a smooth bottom.

Note: EXPLORER companies attending regional competitions should note that regionals may be held in pool venues with different environmental conditions than those listed here. If you are unfamiliar with the regional pool, contact [the regional coordinator or visit your regional contest's website](#) for additional information.

3.1.3 Service Requirement

OPER-006: Companies shall provide a crew of at least 3 but not more than 6 people on the pool deck to operate the ROV System. Companies can send a larger crew complement, but no more than six can be on the deck at any time. More information about this "product demonstration team" is provided in the [COMPETITION RULES](#).

3.1.4 Maintenance and Calibration Requirement

OPER-007: All measurement devices shall be calibrated according to manufacturer recommended calibration procedure and performed by company members only. Company mentors or advisors are not permitted to perform calibration procedures. More information about mentor restrictions is provided in the [COMPETITION RULES](#).

OPER-008: System maintenance during field operations shall be conducted by ROV personnel at their workstations. Work of any kind must not be done by company mentors or advisors. All

maintenance parts and equipment necessary to meet the operation requirements shall be provided by the company. More information about these regulations is provided in the [COMPETITION RULES](#).

3.2 Mechanical/Physical

This section of the document provides specifications for the mechanical properties of the ROV system.

3.2.1 Materials

MECH-001: At the world championship, any electronics housings on the ROV shall be capable of operating to depths of 7 meters.

3.2.2 Size and weight

MECH-002: ROVs are limited to a maximum diameter of 92 cm. Vehicles above this size will not be allowed to compete. ROVs are limited to a maximum weight, in air, of 35 kg. Vehicles over this weight will not be allowed to compete. Companies must be able to personally transport the vehicle and associated equipment to the product demonstration station and to the product presentation room. ROV systems must be capable of being safely hand launched. Additional points will be given to smaller, lighter vehicles (see [Size and Weight Restrictions](#)).

3.2.3 Tether Length

NOTE for 2021!!!

MECH-003E: At the world championship, ROVs must be capable of operating in a maximum pool depth of 5.5 meters (18 feet). All underwater product demonstrations will take place within 10 meters from the side of the pool. The product demonstration station will be no more than 3 meters from the side of the pool. Tether length should be calculated accordingly. EXPLORER companies attending regional competitions should note that regionals may be held in pool venues with different maximum depths than those listed here. If you are unfamiliar with the regional pool, contact [your regional coordinator or visit your regional contest's website](#).

3.2.4 Vehicle Deployment and Recovery

MECH-004: The ROV system must be launched and recovered manually; no powered winches or portable cranes can be used. Hand-powered lifts and levers may be used to launch and recover the vehicle. The vehicle and any associated equipment must not damage any part of the pool or pool deck.

MECH-005: Any hand-powered lift or levers that are used as a LARS must be detailed in the technical documentation and must be part of the safety inspection procedure. Any LARS equipment that is deemed as unsafe at the safety inspection will not be allowed. Ladders, tripods, or other bracing equipment are not permitted as part of a LARS.

3.2.5 Propellers

MECH-006: Propellers must be shrouded and have thruster guards. ROVs that have propellers exposed without thruster guards will not pass the safety inspection and will not be allowed to compete. A shroud must completely encircle the propeller and extend at least 2 mm in front of and behind the propeller. Thruster guards must completely cover any openings on the thruster and should have a mesh size that meets [IP-20 standards](#) (solid particulate protection level 2). This IP code equates to a mesh size >12.5 mm. To pass safety inspection, the shroud and propeller guard should meet this standard. If your finger can touch the propeller, then it is not properly guarded.

Teams may construct thruster guards, 3D print thruster guards, or may purchase commercially available thruster guards. All motors on the ROV must be protected with shrouds and thruster guards on all sides.

See <https://www.thingiverse.com/thing:1498338> for an example of an acceptable thruster guard.

3.3 Electrical

ELEC-001: All power provided to the ROV system through an external connection for any purpose during the competition must be obtained from the MATE competition power supply. This includes dedicated lines for cameras, manipulators, and any other devices. This is a singular point of connection; all power to the ROV must pass through the MATE-provided fuse AND the single in-line fuse as specified in this section.

NOTE for 2021!!!

Companies **MUST** use one of the following inline fuse(s) that are rated for the voltages used on EXPLORER class ROVs. Circuit breakers will not be allowed on the ROV system.

[30 amp fuse](#)

[25 amp fuse](#)

[20 amp fuse](#)

[Fuse holder](#)

Companies may also purchase fuses and fuse holders from the [SeaMATE store](#).

ELEC-002E: The ROV system must be capable of operating off the power provided by a MATE supply with a nominal voltage of 48 VDC. This voltage may be as high as 56 volts. Power supplies will be a fixed output voltage and will not be “turned down” to accommodate other than the specified voltage for the class. All references to 48 VDC in this document are the nominal voltage of 48 VDC, which must be within the ranges specified in this paragraph.

ELEC-003E: The ROV system must deliver the supply voltage to the ROV as provided and without modification. No conversion of this voltage is allowed prior to it arriving at the ROV system bus. Methods on the surface such as DC/DC converters, voltage drop resistors, and Pulse Width Modulation (PWM) are not allowed to be used between the ROV and the power source. ESCs and H-bridges are not

allowed on the surface. Power supplies and conversion devices are not allowed on the surface if they operate the ROV.

MATE strongly urges companies to refrain from sending reduced voltage signals from the ROV back up the tether to power devices on the surface. This is not done by ROVs in industry and therefore discouraged by the MATE ROV Competition.

ELEC-004E: ROV systems may use any voltage desired up to 48 Volts, but any conversion to a lower voltage must be made on board the ROV. Companies will not be permitted to operate an ROV that reduces the voltage on the shore-side/top-side end of the ROV tether.

ELEC-005E: Voltage may not be increased above the nominal 48 volts anywhere in the ROV system.

ELEC-006E: Sonar or other systems that may have DC/DC conversion resulting in voltages above 48V nominal are not permitted.

ELEC-007E: Voltages in excess of the class parameters set forth in this specification are not allowed on the ROV system at any time other than any inductive spikes that are caused by the switching on/off of motors, solenoids and other inductive devices. Companies should design their systems to handle these voltage spikes but will not be penalized for the presence of these in a system. For additional information on this, companies can research back electromotive forces (back EMF), collapsing magnetic motor fields, and transient suppression.

3.3.1 Non-ROV Device Power Specifications

NOTE for 2021!!!

Systems that qualify as a non-ROV device in 2021:

- new power connector for the Seabin
- device deployed into the drain pipe

No other devices qualify as non-ROV devices.

ELEC-NRD-001: Non-ROV devices can be powered from the surface or from batteries onboard the device. Power is limited to 12 VDC maximum and 6 amps maximum.

At the World Championship, MATE will provide a 12-volt [Powerwerx power supply](#) at each station. The company built non-ROV device may be plugged into this power supply. No other devices may be plugged into this supply. The connection to the MATE provided supply will be red/black [Anderson powerpole connectors](#). <https://www.andersonpower.com/shop/powerpoler-15-45-one-row-1x2-assembly-bonded-kr.html>

Note: The Powerwerx power supply typically operates at 14.1 volts.

Micro-ROV / device deployed into the pipe: If powered from a 12 volt surface supply, the tether for the device deployed into the pipe (micro-ROV) must be incorporated completely into the primary ROV tether. While power for the micro-ROV does not need to pass through the single point of connection to

the 48-volt power supply, the micro-ROV tether must run alongside and be securely attached to the primary ROVs tether at the surface and where it enters the ROV. For example, the micro-ROV tether may be incorporated inside the primary ROV's tether sheath, taped or zip-tied to the primary ROV's tether, etc.

The new power connector for the Seabin using a 12 volt surface supply does not need to be incorporated into the primary ROV's tether.

ELEC-NRD-002: The device deployed into the drain pipe may contain thrusters and cameras. Thrusters for a Micro-ROV are not required to be shrouded. However, if a powerful motor might cause injury or damage the pool or mission props, companies should consider protecting or shrouding the motor.

ELEC-NRD-003: If powered from the surface and through the ROV, any non-ROV device must have a 7.5 amp (or smaller) fuse within 30 cm of the point of connection.

ELEC-NRD-004: Onboard power is allowed for non-ROV devices. If onboard batteries are being used, the following specifications must be met:

- Batteries must be primary (non-rechargeable).
- AAA, AA, A, A23, C, D or 9V alkaline batteries are allowed. No other size or chemical composition is allowed. 12 volt, outdoor, rechargeable batteries are **NOT** allowed. High discharge LiPo batteries are **NOT** allowed.
- Batteries are mounted in a manner that they are not loose inside the container.
- A fuse (7.5 amps max) must be installed within 5 cm of the battery positive terminal.
- The enclosure housing must be designed so that it will open if the pressure inside the housing is greater than the outside pressure.
- Any pressure relief plug **MUST** be at least 2.5 cm in diameter. Smaller plugs will not pass safety inspection.
- The enclosure housing must be designed so that it will release pressure if pressure inside the housing is greater than the outside pressure. Under no condition should the housing be built with fasteners to hold the device together if there is no pressure release valve. At least one opening must serve as a pressure release. This can be achieved by:
 - The battery holder must be mounted in a manner that will allow the end cap to freely open if pressure develops inside the housing.
 - Battery containers utilize a pressure release valve **AND** a Schrader valve. The pressure release valve must be rated no more than 3 psi.

Companies using a pressure release valve for their onboard battery container provide specifications and factory cut sheets of the valve used to the [Competition Technical Manager](#) no later than May 15th, 2021 for review by the MATE safety committee.

Examples of acceptable methods for housing batteries include:

- A PVC pipe with wires penetrating one end and the opposite end plugged with a pressure release plug (rubber stopper, etc.). Note: Any pressure release plug MUST be at least 2.5 cm in diameter. Smaller plugs will not pass safety inspection.
- Cylinder with batteries mounted inside. One end of the cylinder sealed with caps and O-rings, but no fastening devices holding the end cap on.
- Cylinder with both a properly rated pressure release valve and a Schrader valve.

ELEC-NRD-005: An SID must be submitted for any non-ROV device that uses electrical power.

3.3.2 Independent Sensors

Certain product demonstration tasks may require a sensor that is independent of the vehicle. These electrically powered sensors will operate under the following independent sensor rules.

ELEC-IS-001: Independent sensors must be powered from the surface; no onboard batteries are allowed.

ELEC-IS-002: Companies may use USB to connect their sensor to a computer. Companies may also use surface battery packs (limited to 12 volts maximum) or the MATE supply to provide power for their independent sensor.

ELEC-IS-003: The independent sensor may only contain the intended sensor; thrusters, cameras, or other systems MAY NOT be attached.

ELEC-IS-004: Companies that use an independent sensor must provide a 3 amp (or less) fast blow fuse on the positive side of their connection. If companies are using the 12 volt MATE supply to power their sensor, both the ROV and the sensor must run through the single fuse before splitting off to the 3 amp sensor fuse. Companies using USB only to power an independent sensor may utilize the built-in current limiting of USB and do not need to add an additional fuse.

ELEC-IS-005: An SID must be submitted for an independent sensor that uses electrical power.

3.3.3 Current

ELEC-008E: ROVs will be limited to 30 amps.

The ROV system must have a fuse that is calculated based upon the maximum current draw of the ROV. This overcurrent protection must be calculated as follows: $\text{ROV Overcurrent Protection} = \text{ROV Full Load Current} * 150\%$. The overcurrent protection value may be rounded up to the next standard fuse. The ROV Overcurrent Protection value may exceed 30 amps, but companies are limited to a 30 amp fuse. Companies must use a fuse that is rated for overcurrent protection. Companies that use a fuse larger than their calculated value will not pass safety inspection. Companies may use a fuse smaller than their calculated value without penalty. The fuse must be installed in the positive power supply line within 30

cm of the power supply attachment point. The fuse may be a slow blow type. The SID and other electrical diagrams must show the fuse and include the amperage of the overcurrent protection. In addition, the SID must show the calculations used in determining the overcurrent protection value. SIDs without these calculations shown will have points deducted from the initial safety inspection sheet. Also, SIDS without fuse calculations will not pass safety inspection.

ROV overcurrent protection example:

- Eight motors, 2.7 amps each = 21.6 amps
- Two cameras = 0.25 amps
- Two servo motors = 0.8 amps
- One laser = 0.002 amps
- Total Amps: **22.87 amps** X 150% = **33.98 amps**
- ROV uses a **30 amp** fuse

All information on overcurrent protection should be included on the SID. Show your work.

The MATE power supply will be protected by a 30 amp fuse; however, the ROV system must also have its own calculated fuse.

ELEC-009E: ROV systems are allowed one replacement fuse during the product demonstration. In the event that the ROV system blows the second fuse during the demonstration, the demonstration will be over and no additional points will be earned. Companies should have adequate replacement fuses on hand, MATE will not provide replacements. Standard sizes for fuses are 15, 20, 25 and 30 amps. Additional standard fuse sizes are 1, 3, 7.5, and 10 amps.

3.3.4 Power Connections

ELEC-010E: Power supply connections will be Anderson Power Connectors. Companies' ROV system power wires must have proper connectors to obtain power. The Anderson Power Connectors must be connected to the ROV power wires securely; use of proper (hydraulic) tooling is required. Hand crimp tools do not have the force necessary to ensure proper and safe connections. MATE will not provide companies with connectors or adapters at the 2021 World Championship.

<https://www.andersonpower.com/shop/blue-sbsr50-standard-housings-up-to-110-amps.html>

Housing: Anderson SBS50BLU-BK

Pins: The proper pin for your tether conductors

12 or 10 AWG: [Anderson 1339G3-BK](#)

8 AWG: [Anderson 1339G5-BK](#)

6 AWG: [Anderson 1339G2-BK](#)



<http://leeselectronic.com>

MATE strongly discourages the use of Anderson Powerpole “knock-offs.” These connectors do not meet electrical specifications and have the potential to melt under load. Companies unable to locate a source of genuine Anderson Powerpole connectors can purchase Anderson Powerpoles from the SeaMATE Store or should contact their regional coordinator.

NOTE for 2021!!!

Companies not able to purchase Anderson Powerpole SBS50 connectors in their area can purchase connectors from the [SeaMATE store](#).

ELEC-011E: The power supply may be located up to 1 meter from the station table and may be located on either side of the table. MATE recommends a power cable long enough to reach the power supply up to 3 meters from your control system.

3.3.5 Tether Voltages

The signals in the tether must meet the following specifications:

ELEC-012E: Low voltage, low current AC or DC control or sensor signals. Low voltage is defined as a voltage equal to or less than the maximum supply voltage per class specification. Low current is defined as being less than 500mA. Examples include video signals, control signals for electrically powered manipulators, sensor signals, etc.

ELEC-013E: DC main-supply at a nominal voltage of 48VDC as provided by the MATE power supply.

ELEC-014E: Ethernet, USB, or other ANSI or IEC accepted serial protocol signals.

NOTE for 2021!!!

All cameras, including USB cameras, must be powered by the MATE supply. Powering a USB camera from the MATE supply can be accomplished by using a USB repeater / extender that has a separate power input at the far (ROV) end. The ROV must convert the 48V to 12V or 5V as needed to power the device

from the MATE 48 volt supply. This conversion must be done on the ROV. USB cameras plugged directly into laptops are not allowed. Be sure to denote camera power on your SID.

If a company is using and onboard power for their non-ROV device retrieving the sediment sample from the drain pipe, cameras on board the device may be powered from the onboard batteries. Cameras may not be used on any other non-ROV device.

ELEC-015E: NTSC or PAL Video signals

ELEC-016E: Fiber optic cabling of any type may be used.

3.3.6 Exposed connections and disposable motors

ELEC-017E: ROVs with electrical connections that are exposed to water and not sealed are not permitted to enter the water. Taping a connection with electrical tape only does not constitute a sealed connection. The process of sealing electrical connections must include methodologies such as, but not limited to, Silicone RTV, hot melt glue, epoxy, self-vulcanizing tape, and enclosure of the connections in a housing.

ELEC-018E: “Disposable motors” are not permitted; these are exposed motors with no waterproofing.

Brushless motors must be properly waterproofed. Companies must show manufacturer documentation showing their brushless motors are waterproof, or companies must properly waterproof their motor and provide documentation showing their methodology. Non-sealed brushless motors will not pass safety inspection.

See the [MATE Technical Bulletin](#) for proper methods to waterproof a brushless motor.

3.4 Onboard Electrical Power

ELEC-019E: Onboard electrical power (i.e., power not provided by the tether): Onboard battery power is not allowed on the primary ROV. See the [Non-ROV device power specifications](#) regarding onboard power.

NOTE: Water leaking into a closed battery container can result in the generation of hydrogen gas. This gas can build up inside a pressure housing and create an unsafe situation. Any battery housing must be designed to open if the pressure inside the housing is greater than the outside pressure to meet the MATE safety standards. See the non-ROV device onboard battery rules (ELEC- NRD-004) for more information.

3.5 Power Shutdown

ELEC-020E: For safety purposes, any ROV system that is disconnected from the surface supply must stop functioning in less than 5 seconds. This applies to electrical, pneumatic, and hydraulic power sources. Any filters, capacitors or accumulators must be sized accordingly to meet this specification.

3.6 Fluid Power

Any vehicle using fluid power must provide a fluid power diagram. Fluid power is defined as hydraulic pumps (water) or pneumatic pumps (air) on the vehicle or on the surface.

3.6.1 Hydraulic Power

FLUID-002: Hydraulic fluid: Water or biodegradable food-grade fluid, only.

FLUID-003: If a biodegradable food-grade fluid is used, a Material Safety Data Sheet (MSDS) must be provided at the safety inspection. The MSDS must show the type of fluid used and its compatibility with the Biodegradable Food-Grade specification. Companies using water do not need to provide an MSDS.

FLUID-003: If a biodegradable food-grade fluid is used, a Material Safety Data Sheet (MSDS) must be provided at the safety inspection. The MSDS must show the type of fluid used and its compatibility with the Biodegradable Food-Grade specification. Companies using water do not need to provide an MSDS.

FLUID-004: The following fluids are approved for use in hydraulic systems:

- a. Water
- b. Biodegradable Food-Grade Hydraulic Oil ISO Grade 32/46, SAE Grade 20, McMaster-Carr part# 3499K22

All other bio-degradable food-grade fluids must be approved by the [Competition Technical Manager](#) by May 15, 2021.

FLUID-005: Maximum Hydraulic pressure allowed: 10.33 bars (150 psig).

NOTE for 2021!!!

FLUID-006: Hydraulic system: All lines, fittings, and hydraulic devices must be rated for a minimum pressure of two (2) times the maximum supply pressure.

FLUID-007: Hydraulic pumps must be part of the safety inspection.

1. They must have a pressure relief valve with a maximum setting of 300 psig or less installed before the pressure regulator.
2. The pump must have a regulator in place and set to 150 psig or less.
3. Pumps with any sign of external rust or deterioration will not be accepted.
5. All wiring must be secure.
6. All guards must be in place.

7. Hydraulic pumps may run off of the 15A 115VAC outlet provided for command and control as long as the hydraulic fluid is not used to propel the ROV. The hydraulic fluid is to be used for grippers and actuators only.

3.6.2 Pneumatic Power

FLUID-008: Pneumatic fluid: Compressed air or inert gas only

FLUID-009: Maximum pressure allowed: 2.75 bars (40 psig)

NOTE for 2021!!!

FLUID-010: Pneumatic system: All lines, fittings, and pneumatic devices must be rated for a minimum pressure of two and a half (2.5) times the maximum supply pressure. For example, if an 83 bar (1200 psig) tank is regulated to 2 bars (30 psig), then all system components must have a minimum rating of 5.17 bars (75 psig). **Note: Aquarium tubing is not generally rated for the pressures associated with compressed gas systems and should not be used in a pressurized pneumatic system.**

FLUID-011: Air compressors must be part of the safety inspection. .

1. They must have a pressure relief valve installed before the pressure regulator.
2. The compressor must have a regulator in place and set to 40 psig or less.
3. Compressors with any sign of external rust will not be accepted.
4. The tank drain valve must open.
5. If more than 5 ml of water exits upon opening the drain valve, the compressor will not be accepted.
6. All wiring must be secure.
7. All guards must be in place.
8. Air compressors may run off of the 15A 115VAC outlet provided for command and control as long as the air is not used for motor thrust. The air is to be used for buoyancy/ballast, grippers and actuators only.

At the World Championship, the MATE ROV Competition will provide compressed air at each station. Companies using compressed air MUST attach to the provided compressed air; companies may not use their own compressor. See **Error! Reference source not found.** for more information.

3.6.3 Pressurized Cylinders

FLUID-012: Pressurized cylinders may be used, but must remain above the water surface and meet the following specifications:

- a. Approved by US DOT (Department of Transportation) or TC (Transport Canada). For regional competitions taking place outside of the US, check with [your regional coordinator](#) for approval.
- b. Have a current official inspection/test sticker and/or stamp.

- c. Stamped with the maximum allowable pressure.
- d. Contain a pressure relief safety device.
- e. May be filled up to the maximum allowable pressure of the cylinder.
- f. Must be regulated at its output to a maximum of 2.75 bar (40 psig).
- g. Must have an easily accessible shut-off valve that is clearly marked with instructions.
- h. May only be stationed on the surface, not on the ROV.
- i. Must be secured in a safe manner such that they will not fall or roll around. If the judges feel that a cylinder is unsafe, they have the discretion to prevent its use.
- j. SCUBA tanks are permitted. They must meet all the above specifications and have a current visual inspection sticker, or “fill permit” visible.

NOTE for 2021!!!

Electronic housings and other enclosures on the ROV must operate at surface pressure. Companies may not pressurize their electronics housing.

3.6.4 Pressure operated devices (PSO)

MATE will allow the use of soft-walled pressure operated devices in the competition provided they meet the following specifications:

- Device uses a pressure release valve of 7 psi maximum.
- Company provides specifications and factory cut sheets of the valve used and a description of the device to the [Competition Technical Manager](#) no later than May 15th, 2021 for review by MATE safety committee.

The intent of the exception to the pressure specifications is to allow the use of bladder type devices and flexible grippers that operate a few psi above ambient and would be destroyed if tested at full MATE pressure specifications. This exception does not apply to cylinders, pressure vessels or other pressure containment devices. If the device is tested to the 40 psi (pneumatic) or 150 psi (hydraulic) MATE specifications, a pressure release valve is not required.

3.6.5 Unpressurized cylinders

FLUID-013: Companies may fill containers on the ROV with air provided those containers never exceed ambient pressure. Any such container should have at least one ¼-inch (6.35 mm) hole drilled into the bottom of the container to allow excess air to spill out.

3.6.6 Pressure Storage Devices (Pressure Accumulators)

FLUID-014: Pressure storage devices are allowed on the ROV if they do not exceed 1.25L in total storage and do not store pressure higher than the allowed pressure for air or hydraulics. It is recognized that a company may not be able to purchase a pressure accumulator that has the proper rating and fits in the space needed. In that case, the company must show that their designed accumulator is capable of withstanding the specified pressures without rupture.

3.6.7 Chemical Creation of Gases

The chemical creation of gases is not allowed.

3.6.8 Fluid Power Quiz

FLUID-015: RANGER class companies planning to use hydraulics and/or pneumatics (i.e., fluid power) are required to take and pass an online quiz with a score of 100%. Companies ONLY using manual pumps and unpressurized containers are not required to take the Fluid Power Quiz, but must still submit documentation regarding their fluid power system.

NOTE: The quiz was developed by MATE ROV Competition technical support staff and competition judges and is designed to ensure that companies understand basic information on these topics and can apply that knowledge to safe practices. The intention is not to add yet another “requirement,” but rather to provide a safe and successful learning experience and competition environment.

The quiz should be completed by the STUDENT company members. Each member of the company does NOT have to take the quiz; students can work together and make it a group effort. **ONLY ONE TEST PER COMPANY.** The company’s instructor or mentor can provide guidance and advice, but the questions should be answered by the students participating on the company. The quiz will be scored and the results provided instantaneously. A score of 100% is considered a passing grade. Companies can take the quiz as many as 5 times to achieve this score.

The quiz must be completed with a passing grade by April 26th, 2021. NO EXCEPTIONS OR EXTENSIONS! Companies will be able to purchase and take the fluid power quiz beginning December 1st. The [fluid power quiz may be purchased here](#). Note that if registration for your regional competition opens after the fluid power closing date, you must still take the quiz before April 26th. Companies failing to complete this quiz within the given time frame will NOT be permitted to use fluid power during their competition event. **NO EXCEPTIONS OR EXTENSIONS! See [6.2 KEY DEADLINES](#).**

FEE TO TAKE THE FLUID POWER QUIZ! The fee to take the fluid power quiz is \$25 for five attempts (no discounts for fewer attempts). Companies will receive immediate access to the fluid power quiz once it is purchased. The link will be included in their receipt.

The following are sources of information on hydraulics and pneumatics. This is not intended to be an exhaustive list, but rather a starting point to encourage companies to seek out additional information and resources.

- Underwater Robotics: Science, Design & Fabrication, published by the MATE Center and MATE Inspiration for Innovation – (see www.marinetech.org/underwater_robotics)
- <https://www.nfpa.com/home/About-NFPA/What-is-Fluid-Power.htm>
- <https://www.quincycompressor.com/tips-for-working-safely-with-compressed-air/>
- Parker Hannifin Corporation – <http://www.parker.com/> (look for technical literature links)

3.7 Control Systems

ELEC-021E: EXPLORER class ROVs are expected to utilize computer (or electronic) based control methodologies and H-Bridge or BLDC controllers for the thrusters. Systems using surface switch box controllers will not be permitted.

ELEC-022E: Surface control stations must be built in a neat and workmanship like manner. Loose components and unsecured wires will not pass safety inspection.

ELEC-023E: Surface control stations by nature combine 120VAC and 48VDC wiring. The surface control stations must be wired in a manner such that the 120VAC wiring is physically separated from the DC wiring, the 120VAC wiring is clearly identified from the DC and control voltages, and every conductor is insulated in a manner that no conductor is exposed. Identification can be through signage and/or wire color schemes. All 120VAC wiring colors must use ANSI, NEMA or IEC standard wiring colors appropriate to each voltage. There must be a sign inside the surface control station indicating which wiring standard is being utilized. Companies that do not have adequate separation of AC wires and components and DC wires and components will NOT pass safety inspection. It is recommended that separation be designed into the control system to keep power systems separate. Wiring should be clear, neat and easy to follow by inspectors. Wiring “Rat’s nests” or “spaghetti wiring” will not pass safety inspection.

ELEC-024E: Companies must use proper strain relief and abrasion protection where wires and the tether enter the vehicle. The ROV should be capable of being lifted by the tether without damaging the tether connection to the ROV. Tape, glue, zip ties, and other quick methods of strain relief are not acceptable. The intent is to see the wires pass through a connector specifically designed to provide strain relief.

Examples of some acceptable strain reliefs for the ROV side include:

[Hubbell Strain Relief 1](#)

[Hubbell Strain Relief 2](#)

[Strain relief grip](#)

[Kellums strain relief cord grip](#)

ELEC-025E: Any connectors utilized in the surface control station and elsewhere in the ROV system must be properly type rated for their application. AC rated connectors must not be used for DC. The connectors must also be rated at or above the voltage and current used in their application.

3.8 Command, Control, & Communications (C3)

3.8.1 Power Provided

CCC-001: Surface power: MATE will provide one GFI-protected outlet with a nominal 115 Volts AC (60 Hertz) and 15 amps maximum. This outlet is intended to provide power for pumps and other surface

support equipment (e.g. video monitors & control boxes). This AC power source CANNOT be used to directly or indirectly power the vehicle.

CCC-002: If hydraulic or pneumatic power is used for vehicle thrust, the power for the pump must come from the MATE supplied DC power supply.

CCC-003: In addition to electric pumps, hydraulic, and pneumatic systems can be powered by manual pumps (e.g. bicycle tire pump) or supplied from a pre-pressurized cylinder. Companies that are only using manual pumps must still comply with all hydraulic and pneumatic specifications, including the creation of a fluid power SID.

3.8.2 Displays

CCC-004E: Companies are not limited to the number of display screens used for video feeds or ROV status information. Display devices may be made up of any combination of TVs, monitors, laptops, and/or computer displays.

CCC-005E: These display devices may be powered by the MATE provided GFI-protected 115-Volt AC (60-cycle) and 15-amp AC power source described in CCC-001, Surface power.

CCC-006E: A company's C3 station may include devices like video recorders. All C3 devices must be able to run on the single AC power outlet provided or on its own internal battery power. Any device plugged into this AC power outlet can only provide C3 functions and cannot provide power to the ROV.

3.9 MATE Provided Equipment

MATE will **NOT** provide video monitors at the product demonstration stations.

In 2021, the MATE ROV Competition will supply compressed air at each station during the World Championship. Companies may connect to this compressed air via a standard ¼-inch NPT male fitting. Contact your [regional coordinator or visit your regional contest's website](#) as to whether compressed air will be provided at your regional competition.

3.9.1 Companies Sharing Equipment

Companies may share the following equipment during the competition event: monitors, joysticks, and compressors.

Companies may NOT share the following equipment during the competition event: control systems and payload tools (e.g. grippers, manipulators).

For companies attending an EXPLORER regional, contact [your regional coordinator or visit your regional contest's website](#) to determine if equipment can be shared at your regional event.

Companies that plan to share equipment during the world championship event must notify the [Competition Technical Manager](#) at least 4 weeks prior to the event so that this can be considered when creating the schedule. MATE will do its best to accommodate companies sharing equipment.

3.10 Laser Safety Rules

LASR-001: **Companies must forward the specifications of their laser to the [Competition Technical Manager](#) by May 15th, 2021. Specifications MUST include a link to the laser being used. The link should include a photo of the laser and the laser specifications.** A notification will be sent to the company when the laser is approved. Companies must also bring a copy of their laser specifications to their safety checks. If the laser is being used at a regional event or pool practice, notification will also be sent to the regional competition coordinator.

LASR-002: All lasers must operate in the visible range at either the 630-680 nm (red) or near the 532 nm (green) wavelength. All lasers must fall into the Class I, Class II, or Class IIIa category. Red lasers must operate at 5mW or less. Green lasers must operate at 1 mW or less.

LASR-003: Companies should include detailed specifications of their laser in their technical documentation as well as have that information ready and available during their safety inspection and product presentations.

LASR-004: Lasers must have an on/off switch. This switch must be on the surface controller.

LASR-005: All lasers must be powered by the MATE surface power supply. Batteries, including batteries for powering lasers, are not permitted on the vehicle.

LASR-006: Companies using lasers cannot increase the voltage or the current to increase the power of their lasers. Lasers must use the voltage and current set in their specifications.

LASR-007: When out of the water, the laser should have a shield or enclosed beam stop attachment within 30 cm of the laser. This means that the laser beam should not travel more than 30 cm before reaching the shield. This is a requirement at all times when the laser is out of the water. The shield does not need to be attached to the ROV while it is in the water. The shield must be painted with FLAT BLACK paint.

LASR-008: At no time should the laser be focused or deviate from a collimated beam.

LASR-009: When testing the laser at a workstation, companies must display a sign telling others that a laser is being operated.

LASR-010: Operators working with the laser while the ROV is out of the water should wear appropriate laser safety glasses at all times. This requirement is for all laser types. Search online to find laser safety glasses appropriate for the wavelength being used.

Companies must forward the specifications of their laser safety glasses to the [Competition Technical Manager](#) by May 15th, 2021. Specifications MUST include a link to the laser safety glasses being used. The link should include a photo of the laser glasses and the laser specifications. A notification will be sent to the company when the laser safety glasses are approved. Companies must also bring a copy of their laser safety glasses specifications to their safety checks. If more than one brand of glasses are used, a copy of each specification sheet should be provided.

The following lasers are acceptable to use in the MATE ROV Competition, although companies may choose to use alternate lasers. NOTE: **ALL COMPANIES MUST STILL FORWARD SPECIFICATIONS TO THE COMPETITION TECHNICAL MANAGER, EVEN IF ONE OF THE FOLLOWING LASERS IS USED.**

- https://www.amazon.com/HiLetgo-10pcs-650nm-Diode-Laser/dp/B071FT9HSV/ref=sr_1_1?keywords=5+volt+laser&qid=1569876182&sr=8-1
- https://www.amazon.com/HiLetgo-Adjustable-Positioning-Telescope-Horizontal/dp/B072XF49LK/ref=sr_1_4?keywords=5+volt+laser&qid=1569876537&sr=8-4

PART 4: COMPETITION RULES

4.1 GENERAL

- All members of the company and their supporters must follow the safety regulations of the ROV competition, pool facility, and event venue.
- All company members and their supporters are expected to conduct themselves in a professional and responsible manner during the competition. Disrespectful behavior towards the judges, officials, pool staff, audience, or other companies will lead to penalty points or disqualification.
- Sabotaging, stealing, or pilfering equipment of other companies will lead to disqualification. Companies found cheating will also be disqualified.
- The MATE ROV competition is, at its core, designed to be an educational and inspirational event for **STUDENTS**. It is designed to challenge them to apply the physics, math, electronics, and engineering skills they are learning in the classroom to solving practical problems from the marine workplace. (See the [MATE Competition Philosophy](#).)

It is expected that all “adults” (non-students; e.g. teachers, mentors, parents) involved in the competition limit their input to educational and inspirational roles. Actual construction of the ROV (particularly in the complex electrical and software areas) must be completed by the students. Adults should teach and advise students about design, electronics, software, and construction, but not complete the work for the students. Throughout the process adults are encouraged to focus on benefits to the students from the process and not simply winning. If it

becomes apparent that adults exercised more than an advisory role, judges reserve the right to deduct points or, in extreme cases, disqualify companies from the competition.

ALL work done on the vehicle must be conducted by company members. This includes any work done at home, at school, or during the MATE ROV competition (world championship and regional). Teachers, mentors, parents, and non-competing students are not permitted to work on the ROVs. They may provide advisory input, but they may not work on the ROV directly. This includes writing or editing software code. All mechanical, electrical, and software modifications and/or repairs to the ROV must be completed by students.

With learning at its core, the MATE competition encourages students to utilize and build upon their skill sets to find creative solutions to designing and building their ROV. Students gain valuable skills and knowledge when creating a component from “scratch,” which is apparent to judges as they review the technical documentation and engineering presentation. However, as they move through the process of analyzing their designs and identifying building materials, students may decide to either build a component from “scratch” or purchase it from a commercial vendor.*** So, while original solutions are encouraged, the use of commercial components is acceptable, provided 1) that the components adhere to the design and building as well as safety specifications for the particular competition class and 2) more importantly, that the students can provide a reasonable, logical explanation for buying versus building.

The competition scoring rubrics are designed to reflect this; points are awarded based on students’ abilities to explain and justify how all of the components and systems work together as an integrated ROV, regardless if they purchased them, pulled them from public libraries, or made them themselves.

***Note “commercial vendor” includes the SeaMATE store and other competition programs that sell educational robotics kits. SeaMATE kits were created to remove barriers to participation for teachers and schools unable to easily 1) find parts and materials and 2) set up accounts with multiple vendors. The kits are part of a larger educational package offered by the MATE Center that includes curriculum materials, videos, and other resources to support and enhance learning. And learning is what students who use SeaMATE (or other) kits will be expected to demonstrate during and through the [ENGINEERING & COMMUNICATION](#) components.

It should be noted that purchasing and competing with complete, assembled, commercial ROVs is not permitted.

4.2 PROCEDURAL

- Companies must compete during their assigned time slots. Your company is **NOT** permitted to switch time slots with another company. Failure to show for your scheduled product demonstration or for your company’s product presentation will result in “no score” for that particular competition

category. **No exceptions.** Assigned time slots will be sent out in advance so that any scheduling concerns can be addressed prior to the event.

- Companies must complete their size and weight measurements before each product demonstration run. The size and weight measurements are included as part of the product demonstration score. Companies should be at the size and weigh in area at least 20 minutes before their scheduled product demonstration run.
- While there is no limit to the number of students who can compete as part of a company, **the product demonstration team (aka demo team) is limited to six students.** The demo team is defined as the team of students who operate the vehicle and its associated equipment during the product demonstration. Only six students will be allowed to enter the product demonstration station, launch, pilot, and perform the tasks. Instructors, mentors, and/or non-student members cannot participate as part of the demo team. **Companies may alternate students on the demo team for the two product demonstration attempts.** (All members of the company should participate in the engineering and communication components; see [ENGINEERING & COMMUNICATION](#) for more information.)
- Only the demo team members and judges are allowed at the product demonstration station during the product demonstration, which includes the set-up and demobilization periods. Other members of the company, instructors, mentors, audience members, and observers (press or special invited guests) must remain outside the product demonstration station or in designated viewing areas.
- Instructors, mentors, parents, and “fans” are **NOT** permitted at the safety inspection stations or repair tables. Two warnings will be issued before individuals not heeding this rule will be asked to leave the venue.
- In addition, instructors, mentors, parents, and fans are **NOT** permitted to work on the ROV. Individuals who are seen working on the ROV who are not student company members will be issued a warning. Two warnings will be issued before individuals not heeding this rule will be asked to leave the venue. If companies choose to take their ROVs off the competition grounds for maintenance and repair, they are expected to observe this rule in the interests of the spirit of the competition.
- To help enforce this, teachers, mentors, parents, and non-competing students **MAY** have limited access to the work station areas.
- Video devices may be used to record the underwater activities for entertainment and learning purposes **only.** Video will not be used as an instant replay to review judges’ decisions or to challenge product demonstration timing.

- Product demonstration stations will be roped off and marked. Product demonstration stations will contain 2-3 chairs and one 6-foot table long table for companies to use. This table will be within 3 meters of the pool edge. Product demonstration stations will be set up to prevent the pilot(s) from looking at the ROV in or under the water except through the ROV cameras.
- Companies will compete in one product demonstration that will consist of three tasks. Companies will get TWO attempts at the one product demonstration. The higher of the two scores will be added to the engineering and communication score to determine the total, overall score for the competition.
- The product demonstration time consists of a 5-minute set-up period, a 15-minute performance period, and a 5-minute demobilization period. If the demo team and all of their equipment are not out of the product demonstration station at the end of the 5-minute demobilization period, the company will be **penalized 1 point for each additional minute.**

Note: For companies attending an EXPLORER regional, those competitions may allow more or less time to complete the product demonstration. Contact [your regional coordinator or visit your regional contest's website](#) for more information.

- Manipulating the tether to free it from underwater obstacles is permitted. Pulling on the tether to speed up the recovery of items or to return your vehicle more quickly to the surface is not permitted and will result in penalty points. Judges will issue one warning if tether pulling occurs. Each future infraction will result in 5 points deducted from the final product demonstration score.
- SCUBA diver assistance will be available at the world championship. If help is required, the company CEO or pilot must ask a station judge and divers for assistance. Each diver assist will incur a 5 point penalty. The product demonstration clock will not stop if a company is receiving diver assistance.

Diver assistance may not be available at regional competitions. Contact [your regional coordinator or visit your regional contest's website](#) to determine if diver assistance will be available at your regional competition.

- Pilots can only leave the product demonstration station and move poolside to repair, adjust, or alter a vehicle if the ROV is surfaced and at the side of the pool.
- Companies are not permitted to leave debris in the pool. Any debris must be recovered by the ROV before time has expired or the company will be penalized. Debris is defined as pieces of the ROVs, weights, floats, or other items created by the company. Any lift bag release mechanism intentionally left on the anchor are not considered debris. Task props are also not considered debris. The product demonstration notes section may cover special items that can be left in the

pool after time has expired.

- No demo team member shall enter the water to complete an object recovery. Only arms and hands are allowed into the pool to retrieve an object or to retrieve the vehicle. Companies will be disqualified or penalized depending on the severity of the infraction.
- Communication between demo team members at the pool edge and demo team members piloting the vehicle will be limited. Only tether management issues (e.g. how much tether is out, how much is remaining on the pool deck) can be discussed. Those team members at the pool edge cannot give any directional or product demonstration task information to the pilot. Judges will issue one warning regarding illegal communication. Each future infraction will result in **5** points deducted from the final product demonstration score.
- Communication using cell phones, text messaging, and online social media tools such as Skype, Facebook, Twitter, instant messaging, etc. is NOT permitted during the product demonstration, either between the demo team members at poolside or between any demo team member and anyone outside of the product demonstration station. The ROV and/or the ROV control system is not allowed to broadcast video or other information to anyone outside of the product demonstration area. No exceptions. Companies found broadcasting any data to those outside of the product demonstration area will be disqualified.
- **Product demonstration judges and other competition officials will only communicate with students.** Judges and officials will NOT communicate with mentors, parents, or other non-student members regarding product demonstration information, challenges, or other issues except during pre- and post-competition briefing sessions.

Companies that wish to issue a challenge during the product demonstration run should immediately communicate this challenge to the product demonstration judges. The judges will discuss and attempt to resolve the issue. If a decision cannot be made, the product demonstration judges will consult with the head judges and competition technical manager to resolve the issue.

- ***NEW for 2021!!!*** Once a chief judge rules on a challenge, that ruling is final. NO EXCEPTIONS, including appeals to other competition officials. Penalty points may be given if companies continue to pursue the challenge beyond the chief judge's final ruling.

4.3 DESIGN & SAFETY CONSIDERATIONS

- The competition coordinators and host venues stress the importance of safety practices and procedures to all companies. The score sheets and rubrics will reflect the MATE ROV Competition's efforts to encourage and reward companies that demonstrate exceptional safety practices and procedures.

- **ALL ROVS MUST PASS A SAFETY INSPECTION CONDUCTED BY COMPETITION OFFICIALS PRIOR TO ENTERING THE POOL.** These inspections will be conducted topside to ensure that ROV systems meet the design and building specifications and do not pose a risk to the integrity of the event venue. See [VEHICLE DESIGN & BUILDING SPECIFICATIONS](#) for additional information.
- Radio transmitters that operate on a separate battery are permitted. No batteries are permitted to be in or on the water. No exceptions.

Companies should be aware of all the implications of these wireless devices. There is no assurance that an adjacent company's wireless controller will not interfere with your control systems. Adjacent wireless controllers with a battery that has a higher charge than the nearby controller have demonstrated the ability to "hijack" the nearby control signals. In addition, all wireless controllers are susceptible to external sources of electronic interference. Your system may work fine in your home environment, but not in the industrial environment of the competition. MATE will not stop the clock to resolve wireless control issues. Companies deciding to utilize wireless controllers do so at their own risk.

- Keep an eye out for tripping hazards in the product demonstration station and at your company's work station. Make sure power cords are not laying in pools of water on the deck.
- During your product demonstration, be sure to secure any equipment so that it does not fall off the product demonstration station table, damage the deck, or cause injury.
- Loose fitting clothing, jewelry, and long hair could all become safety issues. Consider securing long shirts or baggy pants, removing jewelry, and tying back long hair when working on or operating your ROV.
- ROVs may be constructed out of materials of your company's choice, provided they meet the design and building specifications and safety regulations. Warning labels should be posted on potentially hazardous components of your ROV system.
- Close toed shoes are required on the pool deck. Safety glasses are required when working on the vehicle.
- Personal flotation devices (PFDs) will not be required at the world championship. No personal flotation devices will be provided by MATE or the host venue. Regional events may require PFDs. For companies attending an EXPLORER regional, contact [your regional coordinator or visit your regional contest's website](#) to determine if PFDs will be necessary.

PART 5: ENGINEERING & COMMUNICATION

NOTE for 2021!!!

MATE has created an ROV Competition [Marketing Kit](#) that includes logos and guidelines for their use.

The ability to communicate information about your vehicle and the design and building process is equally as important as how well your vehicle performs. Strong communication skills are an essential part of good business practices and one of the most in-demand skills in the constantly evolving, ever-changing workplace.

To emphasize this point, the competition requires the following four engineering and communication components:

- Company spec sheet
- Technical (written) documentation (Examples of spec sheets and technical documentation from previous competitions can be found at <http://www.materovcompetition.org/archiveshome.>)
- Engineering (oral) presentation (Examples of engineering presentations can be found on [MATE's Vimeo channel.](#))
- Marketing display

NOTE: Regional contests may not require all of the Engineering & Communication components. Contact [your regional coordinator or visit your regional contest's website](#) for more information.

See the [TIPS FOR EFFECTIVE WRITTEN AND ORAL COMMUNICATION](#) for additional information.

NOTE for 2021!!!

Your company should refer directly to the scoring rubrics posted under [Scoring](#) for details on what is required for your technical documentation, engineering presentation, and marketing display. The judges will use the rubrics to evaluate and score these engineering and communication components.

5.1 COMPANY SPEC SHEET

The purpose of the company spec sheet is to provide the judges with a “snapshot” of your company. It includes basic information about your company and vehicle.

Company spec sheets will be reviewed by MATE competition coordinators. Companies will receive up to 20 points for submitting a spec sheet that is **one page** in length, follows the file size and naming specifications, and contains **all** of the following information:

COMPANY SPECS

- **Company and school, club, or community organization name**

- **Home state and/or country**
- **Distance required to travel to the world championship**
- **History of MATE ROV competition participation.** Be sure to specify if your company and/or the members of your company are “new” or “returning.”
- **Company photo and caption indicating members’ names and roles (e.g. CEO, CFO, Design Engineer, Pilot, etc.).** This photo should include all of the members of your company.
- **Range of grade/college levels represented by the members of your company**

ROV SPECS

- **ROV name** if applicable
- **Total cost.** You must include the approximate cost of any donated items.
- **Size and weight measurements**
- **Total student-hours to design and build.** This should include the number of hours that each and every member of the company worked on the vehicle.
- **Safety features**
- **Special features**
- **Photo of the vehicle**

REMINDER!!! If all of the above information is included, the specifications for length, size, and naming conventions are followed carefully, and the document is submitted on time, this is an “easy” 20 points! You can find the company spec sheet scoring rubric posted [here](#).

5.2 TECHNICAL DOCUMENTATION

The purpose of the technical documentation is to challenge you to effectively and efficiently communicate information using clear and concise text along with graphics, illustrations, and data that add to and complement (and not distract from) the information. Your company must organize and present the information in a way that is logical and complete. The document should focus on the technical and safety aspects of your ROV/ROV systems, innovations (“hacks, tips, and tricks”), and include a profile of your company and staff. You should consider this document a reference for both judges and future team members (part of the company’s institutional knowledge).

Your company’s technical documentation will be reviewed and evaluated by a panel of working professionals – individuals who represent science, exploration, government, and industry. (Don’t assume that these same individuals will evaluate your company’s engineering presentation!)

Each judge on the panel will award a score (100 points max). Judges’ scores and comments will be returned to you shortly after the event.

NOTE: The judges will not review and rescore revised versions of your technical documentation during the competition.

Use the technical documentation scoring rubric posted [here](#) as the guideline for the required components for the technical documentation. This rubric will be posted by April 1, 2021. In the meantime, companies may refer to the previous year's rubrics posted [here](#) for a general idea of the categories and points

5.3 ENGINEERING PRESENTATION

The purpose of the engineering presentation is to challenge you to effectively and efficiently communicate information with words and “props” (i.e., the ROV). Your company must organize and present the information in a way that is logical and covers the development and testing of your ROVs and the formation and development of their team. The presentation should be delivered as a “technical brief,” with references to the technical documentation for additional details (companies should present judges with ONE copy of their document at the start of the presentation). The presentation is THE opportunity your company has to 1) communicate directly and in person your critical thinking, creativity, and engineering reasoning (including build vs. buy) and 2) demonstrate your individual and collaborative contributions to the creation of the vehicle.

During the competition, your company will have 15 minutes deliver your presentation to a panel of working professionals – individuals who represent science, exploration, government, and industry. (Don't assume that these same individuals will evaluate your company's technical documentation!) After the presentation, the judges will take 10-15 minutes to ask the members of your company questions about your ROV. The judges will evaluate both your presentation and responses to their questions. Each judge on the panel will award a score (100 points max). Judges' scores and comments will be returned to you shortly after the event.

All student members of your company must be prepared to participate in the presentation and question and answer (Q&A) period. You are required to have your ROV with you. For larger companies, the main presentation may be done by a subset of the overall company. During the Q&A, all members of the company should be prepared to answer. However, if one student is better suited to answer a specific question, the others may defer the question to that student to answer. For example, if a judge calls on the pilot to answer a question about the tether, the pilot can respond by informing the judge that the tether manager was the lead on that system and allow the tether manager to answer without penalty or loss of points.

NOTE: The engineering presentation is designed to be a face-to-face interaction where students and representatives from industry become engaged in conversation. MATE will not provide audio visual aids, such as slide projectors, computer projection screens, white boards, etc.; however, you are welcome to distribute handouts to help judges better understand the information that you are presenting. Electronic forms of presentation (e.g. PowerPoint or Keynote slides) **are NOT permitted.**

Instructors, mentors, family members, friends, and members of other companies are permitted to attend. However, we ask that those in attendance be respectful and courteous throughout the

presentation and follow-up question and answer period. Be mindful that this presentation may be a stressful time for the students. If the room becomes crowded or the spectators become distracting, it is up to the judges' discretion to request that some or all spectators leave the presentation. **While they are permitted to attend, instructors and mentors are not allowed to participate.**

Use the engineering presentation scoring rubric posted [here](#) as the guideline for the required components for the engineering presentation. This rubric will be posted by April 1, 2021. In the meantime, companies may refer to the previous year's rubrics posted [here](#) for a general idea of the categories and points. Judges may ask questions regarding any of these topics not covered in the presentation as well as other questions about the vehicle, the mission theme, or the company.

Preparing for your engineering presentation and Q&A

- Make sure that every member of your company has a good, general working knowledge of your vehicle, even though they may have specialized in one specific aspect of its design and construction.
- Make sure that all the members of your company are familiar with your technical documentation. Ask every member to read it over to catch any errors or omissions. This exercise will help to familiarize everyone with all aspects of the project.
- Generally, you will have more to say about your ROV than can be presented in 15 minutes. That is why it is critical to organize your material and practice communicating it. However, avoid coming across as having memorized your presentation verbatim. Judges want to see that you are prepared and understand the information, not that you can simply regurgitate a rehearsed speech from memory. Ask your instructors or mentors to give you feedback.

Other important items

- If during the engineering presentation it becomes apparent that instructors, mentors, and other adults associated with your company exercised more than an advisory role, judges reserve the right to deduct points or, in extreme cases, disqualify companies.

5.4 MARKETING DISPLAY

The purpose of the marketing display is to challenge you to present technical information in a way that appeals to and is understood by a non-technical audience. It is the promotional piece – you must not only present information about your ROV and your company, but you must also use graphics and design to publicize and “sell” (convince viewers of their value and excellence) your products and people.

During the competition, your company's display will be evaluated and scored by a completely different group of working professionals – individuals who will represent science, business, government, industry, and education/outreach.

While some judges will have a technical background, others will have a communications, marketing, or public relations background. In addition, there will be visitors to the competition who may not completely understand what an ROV is or how it is used. Think of these visitors as potential future clients who may authorize funding for your work, but have a limited understanding of the technology (i.e., you need to explain your technology, the tasks at hand, and “sell” them on YOUR products and services). Design your display to communicate to this type of audience.

Each judge will award a score (50 points max). Judges’ scores and comments will be returned to you shortly after the event.

WORLD CHAMPIONSHIP COMPETITION ONLY!

NOTE: The MATE ROV Competition will NOT supply display boards.

You must provide your own display board. The space that the text and photographs/graphics occupy CANNOT exceed 36” tall by 48” wide. For example, company names CANNOT be mounted above the display board. NO EXCEPTIONS!

At the world championship, easels will be provided for the displays. Companies attending regionals should contact [the regional coordinator](#) to see if tables (easels or other) will be provided at your regional event. Companies should create their marketing displays so that they can be exhibited on either a table or an easel.

MATE will continue to provide scissors, tape, glue sticks, adhesives, and other means of attaching display items to the presentation board, although you are also welcome to bring your own.

Use the marketing display scoring rubric posted [here](#) as the guideline for the required components for the marketing display. This rubric will be posted by April 1, 2021. In the meantime, companies may refer to the previous year’s rubrics posted [here](#) for a general idea of the categories and points.

Creating an effective marketing display:

- Address the theme and make real-world connections.
- Reflect your company’s personality and mindset.
- Make key points and be concise.
- Keep the general public in mind.
- Make sure to label any and all figures, graphs, diagrams, and photographs and credit the source.
- Maximize the use of the 36” by 48” display space.
- Make sure that it is both informational and aesthetically pleasing.

Note: “Accessories” such as video footage, PowerPoint slide presentations running on laptop computers, video projections, etc. are permitted but should be used with discretion. Remember that the judges will have a limited amount of time to evaluate your marketing display and may find excessive use of audio or video presentations distracting.

However, if you do make a video of your ROV building or competition experience, please submit information about it to the [MATE ROV Competition officials](#) so that it can be shared via MATE’s YouTube and Vimeo channels.

5.5 CORPORATE RESPONSIBILITY

The MATE ROV Competition uses underwater robotics to inspire and encourage students’ interest in STEM (science, technology, engineering, and math) education and careers. Recognizing that the students who participate in MATE competitions are powerful ambassadors for the program as well as effective leaders in raising awareness of important issues and bringing about positive change, companies have the opportunity to earn up to 20 points for “corporate responsibility.”

Corporate responsibility includes, but is not limited to, the following:

- **Mentoring** consists of, for example, providing guidance to other students in your area who are designing and building an ROV for the competition or a science or other project.
- **Engaging the community** includes demonstrating your ROV and sharing information about your company at festivities and other community-wide events. Presenting to a Rotary Club or your school districts board of directors are other examples.
- **Media outreach** consists of:
 - o Developing a list local media contacts
 - o Writing a press release about your participation in the MATE ROV competition
 - o Distributing it to your media contacts
 - o Following up with your media contacts to see if they’re interested in your company and its ROV
 - o Compiling a summary of results

Here are some [general guidelines](#) for working with the media. They are specific to the world championship, but can be easily modified for regional events.

- **Raising awareness of environmental, social, and governance (ESG) issues. Just look at this year’s theme and product demonstration tasks for ideas – from removing plastic pollution from our oceans to assessing the health of ecosystems impacted by climate change and creating habitats to promote species diversity.**
- Corporate responsibility efforts will be reviewed by competition coordinators and awarded 0 to 20 bonus points, depending on the number and scope of the outreach and awareness activity(s), i.e., the number of other students or members of the community engaged, the number of mentoring sessions, etc.

Make sure to include the following information in your write-up:

- Type of activity (e.g. mentoring, exhibiting at a community event, raising awareness)
- Locations, dates, and the amount of time spent on the activity
- Number of students or community members (if a large event, this can be an approximate) involved
- Description of your actions, outcomes, and other information that helps to demonstrate the quality of your time and efforts
- For media outreach, please submit a copy of your press release, a copy of your media contacts list, and a summary of news articles, TV or radio coverage, etc. that your company received. Include copies of articles and URLs, and list any television or radio coverage. Be sure to include name of outlet, date, and a summary of the coverage.

TIPS FOR EFFECTIVE WRITTEN AND ORAL COMMUNICATION

Communicating ideas about how to solve a problem and evaluating those ideas against competing alternatives is a critical skill for anyone entering the workplace. It is a skill that is directly linked to decision making about whether or not to hire (or fund) us and our ability to influence the work that we do.

The key to a successful technical documentation and engineering presentation is the way that critical thinking and engineering reasoning are communicated. You can think of the process as technical “storytelling.”

Technical storytelling includes the use of text, images, schematics, and data to effectively communicate the “story” of how your company brainstormed and evaluated ideas to come up with your solution (e.g. ROV, payload tools, and operational strategies) to the problem at hand (product demonstration tasks). It also involves organizing content to efficiently present your work and justify why you did what you did.

However, you should choose details with care. Each detail should help to answer the question “why is what you did the best solution for your company and for this competition?” Describe why a component in the system is critical and how you chose it. Include specifications or dimensions only if they help to explain the “why” and “how” you made choices. Keep in mind that a mechanical drawing with dimensions can replace a lot of text and in many cases do a better job telling details of the story than text.

That said, if something is hard to describe clearly and completely with two to three sentences, consider whether using an image may help. A good technical document balances text and images to provide lots of information concisely, which for a detailed understanding while being quick and easy to read. Remember that your reader is new to your design and needs to understand both what your design is and the process you used to get there. Present text and images in a logical order that helps readers follow your development process and results.

Maintaining a project notebook is a good business practice that will help to capture ideas and document your company's progress – including your research, designs, trade studies, experiments, data, vehicle specifications, testing, expenditures, and donations. The notebook is also a place to keep track of your company member's contributions (time, support, etc.).

Along with your notebook, here are some items to consider as you prepare to tell your story:

- What was your company's "work breakdown structure" (tasks, time, and people)?
- What were the greatest constraints (schedule, budget, equipment, labor, logistics, etc.) on your design process?
- How did the product demonstration tasks and rules influence your design and decisions?
- What systematic process, such as a tradeoff matrix, did you use to evaluate competing design solutions?
- What were the most important design decisions you made and why?
- How did you arrive at your final power budget? What concessions, if any, did you have to make and why?
- How do you calibrate your sensors?
- If your vehicle uses software, where does the code execute? Describe the flow and format of the data.
- Did you have a noteworthy troubleshooting experience? Any problem or procedure that takes more than 20 minutes to figure out is worth understanding and writing down.

PART 6: SUBMISSION GUIDELINES AND KEY DEADLINES

6.1 Documentation

Companies advancing to the world championship are required to submit technical documentation, a company spec sheet, a SID, a fluid power diagram (if fluid power is used), a non-ROV device design document, a non-ROV device SID, and a company safety review. In addition, companies may submit a JSA, documents supporting their corporate responsibility efforts, and assets for the MATE ROV Competition VR World workstations. Companies competing in the telepresence category must also submit their Marketing Display.

NOTE for 2021!!!

The links provided in this section are for companies advancing to and submitting documentation for the world championship. For companies attending EXPLORER class regionals, regional contests may not require all of the documentation. Contact [your regional coordinator or visit your regional contest's website](#) to determine what documentation must be submitted for your regional and the date it is due. Submit regional documentation directly to your regional coordinator.

DOC-006: All required documentation sent to the MATE ROV Competition MUST be in searchable PDF format (see <https://fd4686477cb19f983f54-68abf00cbc1a2cc111562c013cb867db.ssl.cf1.rackcdn.com/SearchablePDFs.pdf> for information about creating searchable PDFs. For companies attending a regional competition, coordinators will provide you with submission guidelines for documentation. See the **Assets for the MATE ROV Competition VR World** document (coming soon!) for the proper format to submissions.

DOC-007: The technical documentation may be up to 8 MB in size, the other documents are restricted to a maximum file size of 2MB.

DOC-008: All documents should use the following naming convention: School or organization name_company name_DOCUMENT TYPE_2021.pdf, where DOCUMENT TYPE is technical documentation, spec sheet, SID [type – electrical or fluid], non-ROV device design, company safety review, or JSA. For the world championship, due date for all documentation is 11:59 PM, Hawaii Time Zone, on July 1st, 2021.

Submission information and forms can be found [here](#).

Submit only your final documents and use only ONE form (multiple files can be attached to one form). Revised documents submitted at a later date and/or multiple forms will not be accepted. The MATE competition will use the date-stamp on your form to determine your initial submission.

NOTE for 2021!!!

Upon submitting your documentation, you will receive a confirmation email noting all of the documents that were successfully uploaded and submitted. **Check this notification carefully to verify that all of your documents were properly uploaded and submitted!** If there was an error while submitting your documents, contact the MATE ROV Competition and upload **ALL** documents again.

6.1.1 Video Demonstration Documentation

DOC-009: Videos must be submitted no later than 11:59 PM, Hawaii time, June 13th, 2021. [Video submission](#) information can be found [here](#). The following naming convention should be used for your video demonstration submissions: School or organization name_company name_video demonstration_2021.

DOC-010: Videos must be submitted as links to a YouTube or Vimeo post. Companies may submit the specification and product demonstration as two separate videos. Note that the product demonstration portion must be a complete, uncut video.

MATE competition organizers will review the videos and respond by June 18th. Video submissions will NOT be accepted after June 13th – NO EXCEPTIONS. Video conferences will not be scheduled after June 13th. If the video does not clearly demonstrate that the company’s vehicle meets the specifications and accomplishes the tasks, the company is not eligible to participate in the World Championship. No extensions past the due date will be given for any reason.

MATE strongly encourages companies to submit their videos or arrange for a video conference with a MATE official well before June 13th. That way, if an issue is found, companies will have the opportunity to address the issue and submit an updated video, or schedule another video conference, before the June 13th deadline. **Note that it may take MATE up to 5 working days to evaluate a video submission or respond to a request to schedule a video conference.**

6.1.2 Image Recognition Documentation

NOTE for 2021!!!

The MATE ROV Competition is not requiring documentation submission for autonomous control or image recognition in 2021.

6.1.3 Corporate Responsibility Documentation

DOC-015: Submission information for corporate responsibility efforts can be found [here](#):

DOC-016: The following naming convention should be used for corporate responsibility documentation: School or organization name_company name_Corporate Responsibility ##_2021, where ## is the number of the document uploaded. You can upload a variety of file types (pdfs, jpegs, etc.) and multiple files, but the size of each file should not exceed 2MB. Number each file to distinguish between them.

Submit only your final corporate responsibility documents and use only ONE form (multiple files can be attached to one form). Revised documents submitted at a later date and/or multiple forms will not be accepted. The MATE competition will use the date-stamp on your form to determine your initial submission.

DOC-017: For the world championship, due date for the corporate responsibility documentation is 11:59 PM, Hawaii Time Zone, on July 1st, 2021.

NOTE: By submitting your documentation, you are giving the MATE ROV Competition permission to publish these documents on its web site.

6.2 KEY DEADLINES

Below is a summary of key dates and deadlines for the 2021 MATE competition season. Note that regional competitions will have their own set of key dates and deadlines. For companies attending EXPLORER class regionals, contact [your regional coordinator or visit your regional contest's website](#) for more information.

- December 1, 2020: Registration opens (note that registration for the World Championship and individual regional competitions will open as locations and dates are secured).

- April 26, 2021: Last day to register for the fluid power quiz.
- May 15, 2021: Last day to submit laser specifications, hydraulic fluid information, and pressure release valve specifications. Companies with regional competitions earlier than May 15 should plan to submit specifications early to allow at least 1 week for approval.
- June 13, 2021: [EXPLORER](#) class video demonstration submission deadline.
- **New this year!!!** June 24, 2021: Deadline for companies that qualify to register for the World Championship in either the In-Person or Telepresence category.

Companies competing in both the In-Person and Telepresence categories of the World Championship have the additional deadlines of:

- July 1, 2021:
 - Technical documentation
 - Company spec sheet
 - SIDs (including electrical, fluid, Non-ROV Device)
 - Non-ROV device design document
 - Company safety review
 - Job site safety analysis (optional)
 - Corporate responsibility documentation (optional)
 - Assets for MATE ROV COMPETITION VR WORLD workstations:***
 - Company name, organization/school name, home state and/or country, and tagline
 - Company logo
 - 3 number of photos for the photo wall
 - Slideshow of images
 - 3D CAD or photo of ROV
 - Marketing display “commercial” submitted as a video, slideshow, or GIF
- NOTE: Details on the VR World workstations assets will be provided in a separate document and are coming soon!**

*****IMPORTANT!!!** Regional competition winners will have 10 days after their regional event to submit their VR WORLD assets; companies progressing through either the [EXPLORER](#) or [RANGER](#) class video demonstration submission pathway will have until July 1 to submit their assets for the VR space, but are highly encouraged to submit their assets early in order to best “promote” their company products and services to the VR World!

Companies competing in the Telepresence category of the World Championship have the additional deadlines of:

- July 1, 2021: Submission deadline for Marketing Display
- July 1, 2021: Deadline to register for a scheduled time slot for the company’s Engineering Presentation, which will take place between July 16-22, 2021
- July 15, 2021: Submission deadline for the company’s Product Demonstration and Safety Inspection videos (**additional details coming soon!**)