

**ROBOTICS**

*Stay Safe! Stay Blue!*

*Arab Academy for Science and Technology  
Alexandria, Egypt*

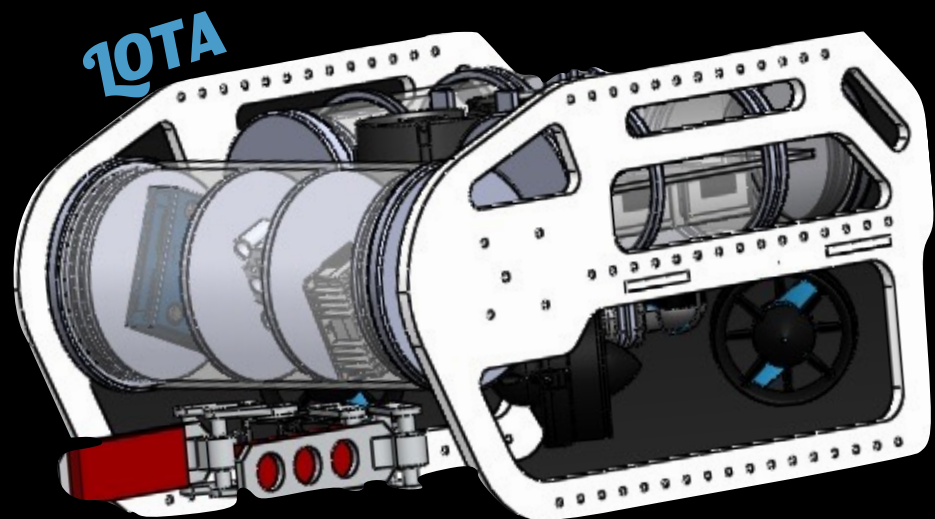

### *Company Staff*

- **Nouran Soliman:** CEO, Co-pilot, software developer/ year 2/ 4th year in underwater robotics, R&D Engineer.
- **Maha Moustafa:** Mechanical engineer, Tether-woman, Technical writing director/ year 2/ 2nd year in underwater robotics.
- **Sondos Omar:** Mechanical engineer, payloads-installer, Safety officer/ year 1/ 3rd year in underwater robotics.
- **Ahmed Ehab:** Electrical engineer, pilot, CFO/ year 1/ 3<sup>rd</sup> year in underwater robotics.
- **Zeyad Medhat:** Electrical engineer, Co-pilot, Ergonomics director/ year 2/ 2nd year in underwater robotics.
- **Ahmed Hamdy:** Software developer, tether man, R&D Engineer.
- **Ahmed Gamal:** Mechanical engineer, Tether-man, Logistics director/ year 1/ 2nd year in underwater robotics.

### *Mentor*

- Eng. Kareem Youssri

## Contents

Acknowledgements .....	1
Abstract .....	2
Mechanical Body Design .....	3
Electrical system .....	5
Subsystems .....	9
Payload tools.....	13
Software .....	14
Safety .....	15
Future improvements .....	16
Budget .....	17
Troubleshooting .....	17
Challenges .....	17
Lessons learned.....	18
Reflections .....	18
References .....	19
Teamwork.....	19
Appendices .....	20

## Acknowledgements

Blue ROVotics would like to express its deep gratitude to its mentor Eng. Kareem Youssri for his patient guidance, enthusiastic encouragement and useful critiques of this project. We would also like to thank Eng. Mohamed El-Kholy for helping the programming team in completing their jobs successfully. Our grateful thanks are also extended to Eng. Galal Samer, who helped us in learning how to use ANSYS software to simulate the ROV's mechanical frame. We wish to thank the Arab Academy for Science, Technology and Maritime Transport, ROV Egypt for sponsoring us and Hadath Company for organizing the regionals. Special thanks to the MATE Centre for giving us the chance to participate in this competition. Thanks to Blue Robotics for supplying us with the T100 thrusters before their release time. Thanks to VideoRay for donating us a 25-m VideoRay tether.

## Abstract

MATE center's 2015 call ensued the innovation of Lord Of The Arctic (LOTA), the ROV designed and constructed by Blue ROVotics to perform the challenging tasks assigned, under harsh circumstances including darkness because of the freezing ice, with high veracity, to deploy instruments, gather data, and replace. LOTA has its driving station, Tether deployment system with a 25-meter VideoRay neutrally buoyant umbilical, and an Ethernet communication along with a joystick interface used in implementing a dynamic positioning system to overcome waves. Seven HD IP cameras are used to ensure a full-angle view for the surroundings and payloads, facilitating the processes of counting, identifying, and the measuring which is achieved using the 3<sup>rd</sup>-class laser. Working in this polar environment requires meticulousness, achieved with 2 parallel-jaw grippers to carry heavy objects with fine grip. The Polyethylene durable frame, ensures conveniently low drag, banishing obstructions to thrusters with brushless vector motors.

Our company's vision included safety as of equal importance to efficiency of technicality. Each component is chosen carefully to fit safely, and testing was done throughout each stage to ensure that LOTA met our standards. This is why LOTA is supplemented with auto-power to switch it off in cases of emergency and a shield is used on the laser to avoid any possible harm above ground. LOTA is the result of Blue ROVotics' tough grind for consecutive months under a precise time plan. This technical report explicates how Blue ROVotics brought LOTA to reality from mere theories, comprising the detailed process.

*~ Word count: 249 words*



**From left to right:** Zeyad Medhat, Ahmed Ehab, Nouran Soliman, Maha Moustafa, Sondos Omar, Ahmed Hamdy, Ahmed Gamal

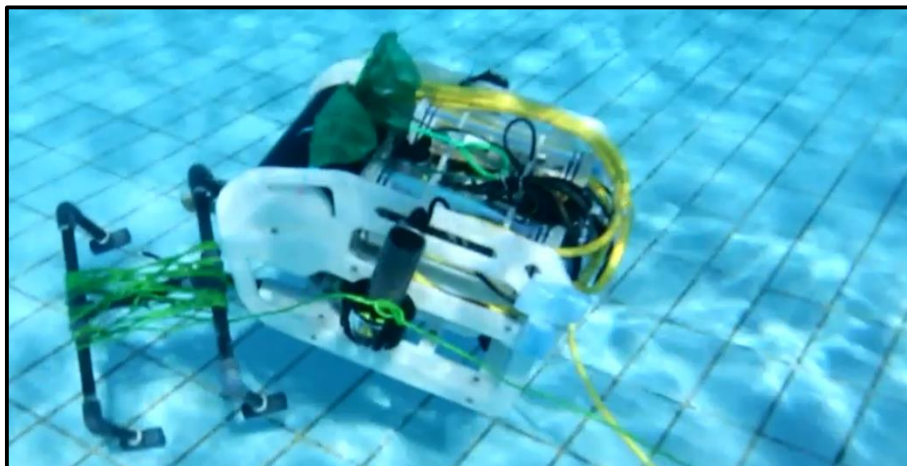

**Real photo of LOTA**

# Mechanical Body Design

## Mission strategy and design focus

This year, ROVotics' focus in the design was more on the criteria of solving the missions proposed by MATE, which veered our senses from creating our own system, and therefore readily made thrusters were used. The major focus in the design process was building a configurable vehicle with very high technology, relatively low cost and wide range of capabilities to satisfy customer's needs. LOTA is produced to aid scientists in their underwater expeditions to explore and study the frigid depths of the Canada Basin. This includes cataloging and sampling organisms, deploying sensors to track the distribution and migratory patterns of whales, and surveying an iceberg. Apart from exploration, LOTA is prepared to perform routine maintenance and repair tasks for underwater oil pipelines as well as assist in the preparation of a wellhead for the delivery of a Christmas tree (Fig. 1 and Fig.2).

## Frame

The mechanical department started looking for a compromise between compact shape, low pressure, steady streamline water flow and high stability. After doing some trials and research (Fig. 3), Blue ROVotics finally settled on the current design of dimensions 55cm x 40cm x 35cm (Fig.4). The major material used in building LOTA is polyethylene, which has proven its efficiency, as well as having the following benefits:

- Low cost.
- Readily available.
- Excellent corrosion resistance.
- Ease of machining and fabrication.
- Moderate strength-to-weight ratio.

LOTA's frame is composed of 3 sheets as shown in Fig.5: 2 identical vertical sheets and 1 horizontal sheet. The horizontal sheet serves as a structure to attach the thrusters, electronics' cans and other ROV components as well as specialized tools, whereas the vertical bumper frames are used to absorb the force of impact protecting the robot from damage when it encounters underwater objects. The 3 sheets are attached to each other firmly (Fig.6). Each sheet contains a number of holes in order to attach any payloads for a specific mission. This makes the ROV more configurable and can be used in different fields, with the possibility of attaching more than 5 extra devices to the ROV.

## Simulations and drag forces

Fig.7 represents the pressure force on the ROV body at a speed of 1m/s and shows that a very small area is subjected to maximum pressure, which is low as compared to the high thrust force of the motors used. Moreover, the rest of the body does not experience any unbalancing forces.



### **SAFETY!**

No sharp edges. Encloses all the ROV components inside it. A safety rope is tied to the frame to pull the ROV when needed during testing.

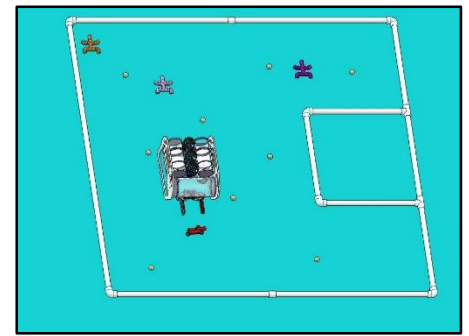

Fig. 1: LOTA during "Science under the ice"

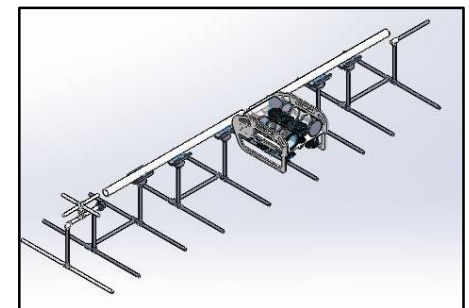

Fig. 2: LOTA during "pipeline inspection & repair"

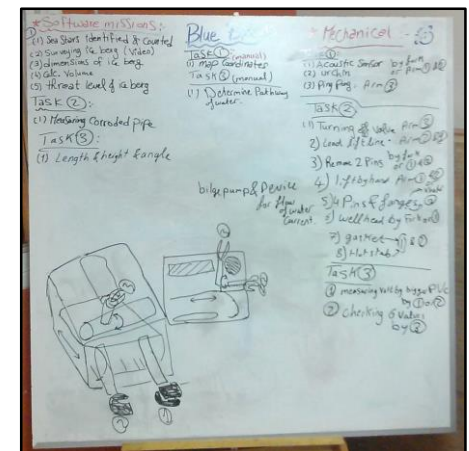

Fig. 3: Initial design & missions' discussion

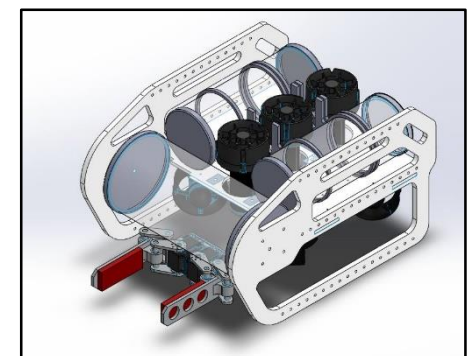

Fig. 4: LOTA on SolidWorks



## Buoyancy and ballast system

Stability can be readily achieved by having buoyancy at the top of the vehicle, thus LOTA has the floating material at the top side. This technique produces an intrinsically stable vehicle, which can be maneuvered with any possible angle.

Equations of body (Fig.8):

Total weight of the ROV= $mg= 10 \times 9.81=98.1\text{N}$

Up thrust= $\rho g \Delta h A=1000 \times 9.81 \times 0.30 \times (12.33 \times 10^{-3}) = 36.28719\text{N}$ .

$F_{\text{net}}=\text{weight}-\text{up thrust} =98.1-36.28719=61.81281$

The floating body consists of 2 ABS 3D-printed pieces (Fig.9) held together by a connector. The volume of the floating body was calculated on SolidWorks. To calculate the ballast system needed to neutralize LOTA's buoyancy, the amount of mass each  $1\text{cm}^3$  of the floating material can hold was calculated first with an experiment carried out by adding mass to a  $10\text{cm}^3$  cube-shaped piece of floating until it was critically floating. Each  $1\text{cm}^3$  of this foam can hold up 1.1g.

Calculating the ballast system needed for critical floating:

Volume of floating material ( $V_1$ )

Mass the floating material holds ( $m_1$ ) =  $V_1 * 0.0011/1 * 10^6$

Mass of ROV ( $m_2$ ) = 10 kg.

$\text{Mass}_{\text{net}} = m_1 - m_2$

The ballast system added to the ROV is slightly lighter than the calculated one; to maintain a slightly positive buoyancy. The ballast system is fit in to specially-designed places at the bottom of the vehicle. One of the major advantages of the ballast system's design is being alterable so that it can be manually adjusted according to the water density.

## Stability

Stability was a major concern during the design process. Blue ROVotics managed to build a very stable ROV which is essential for surveying the iceberg. This is maintained through a number of factors, as equal distribution of forces which gives very high stability in water. One of the other design characteristics that affect the stability of the vehicle is the aspect ratio (total mean length of the vehicle versus total mean width of the vehicle). For ROVs, the optimal aspect ratio depends upon the anticipated top speed of the vehicle, alongside with the need to maneuver in confined spaces. The ratio of LOTA's length-to-width is 3:2, providing high stability. In addition, the distance between the center of buoyancy and center of gravity of the vehicle determines the ROV's stability; as it is a factor of the righting moment. The fourth factor considered by BLUE ROVotics to sustain high stability is the tether pull point as shown in Fig.10. The tether pull point is on the same horizontal plane of the horizontal thrusters, which reduces the moment on the body, therefore reducing the turning effect.



## TESTING!

Maneuvering tests were performed in the pool as soon as LOTA's body had been assembled. The design has proven to be very stable and easily controlled by the pilot, which facilitates the mission execution.

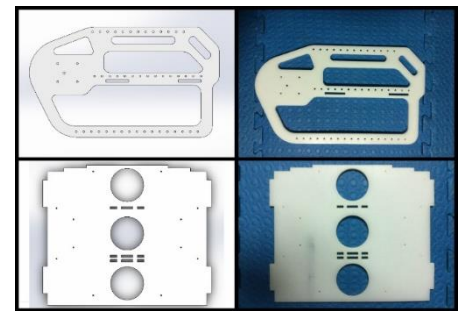

Fig. 5: Frame on SolidWorks and Real



Fig. 6: LOTA's skeleton

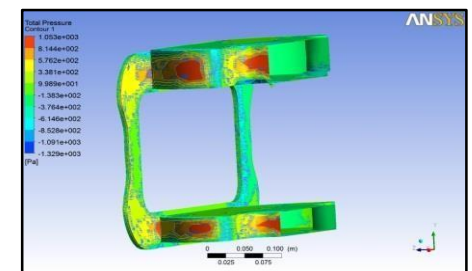

Fig. 7: Simplified ANSYS model of LOTA

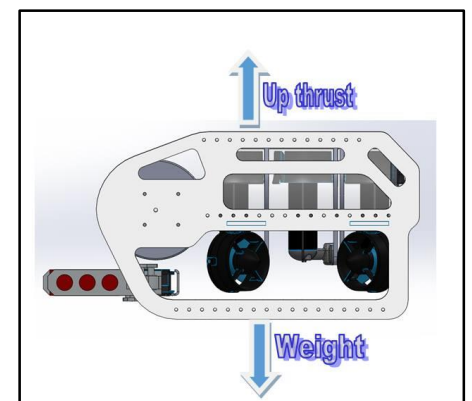

Fig. 8: Forces acting on LOTA in water



Fig. 9: Floating body

## Electronics cans

LOTA contains 3 electronics cans, which enclose all of its electronic components. Each electronics can is composed of an optically clear acrylic cylinder, enduring very high pressure. Acrylic has proven to be a very suitable material, due to its various pros such as:

- Strong, lightweight, and more resistant to impact than glass.
- Highly weather and chemical-resistant.
- Behaves in a firm manner when loaded, especially under an impact force.
- Machine-able and heat-bendable.
- Can be used for canisters for up to 10 meters deep in water.

All the cans are tightly sealed with 2 polyethylene end caps. Each cap has 2 greased O-rings incorporated in it, sustaining complete sealing. Fig.13 depicts the structure of the can and the end cap. Holes are drilled in the end caps in order to pass the wiring of the components inside of the cans. Each wire is threaded through two O-rings, which settle down into the hole tightened around the wire. This sustains total sealing of the electronics cans. Fig.11 shows the electronic can holder.



### **SAFETY!**

No sharp edges. Hard enough to endure pressure.



### **TESTING!**

Sealing was tested in the pressure chamber under very high pressures to ensure complete isolation (Fig. 12).

## Handle

Two laser-engraved openings are designed in the vertical frames to hold the ROV safely and firmly.

## Electrical system

### System layout

As Blue ROVotics aspires development, its R&D department started addressing one of the major technical limitations facing ROV companies by designing an Ethernet control system instead of using the standard protocol RS485 used by most of the companies. Most of ROV companies cannot attach additional devices to their vehicles in order to perform various tasks. As a result, they are forced to rebuild or rent a new vehicle for each task, which is very costly. On the other hand, an Ethernet-based system is configurable, which means unlimited devices can be attached to the system by just extending the network switch. After designing the full system, a power budget was developed to ensure safe power and current consumptions. LOTA's electrical system is divided among 3 electronic cans: 1 main-control can and 2 identical thrusters-control cans. The system diagram and power budget are illustrated in Appendix A.

### Main-control can

The main-control can (Fig.13) contains 3 buck converters, 1 control board to control arm servos, 8 laser pointers, 2 cameras, a tilting system, network switch,

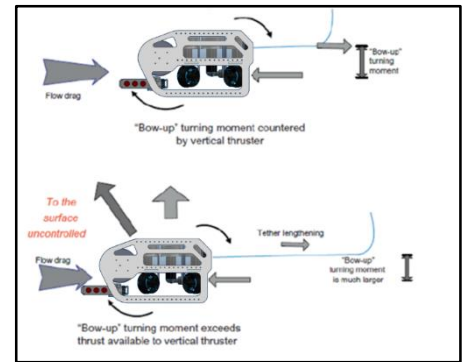

Fig. 10: Tether pull point

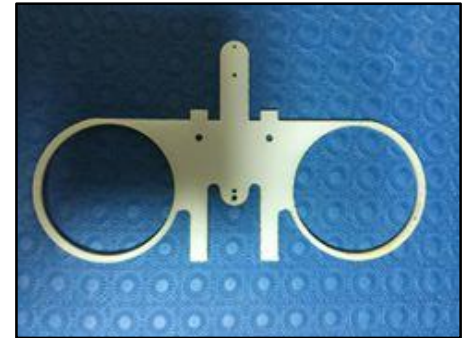

Fig. 11: Electronic cans' holder

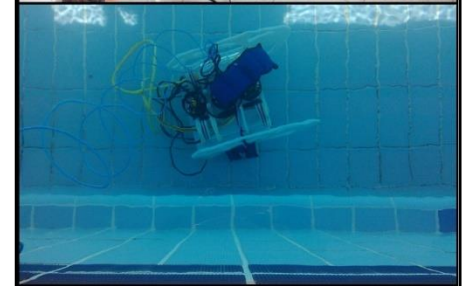

Fig. 12: Sealing tests by Sondos and Maha

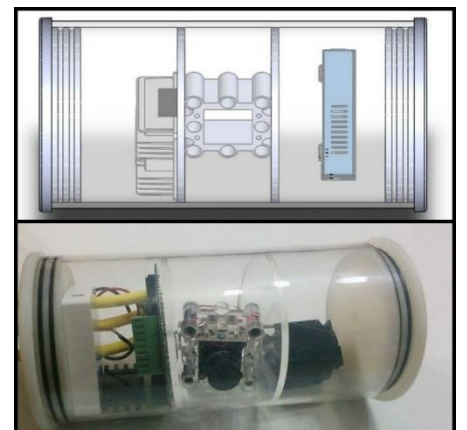

Fig. 13: Real and SolidWorks main-control can

AltiMU-10 V4 sensor, pressure sensor and Ethernet-to-serial converter. This can has an outer diameter of 15cm and length of 30cm.

#### Can conversions

This can contains 3 buck converters (Fig.14). A 48V to 12V (10A) converter powers the control system. A 48V to 12V (20A) powers water pump used for verifying water flow through pipeline. A separate 48V to 5V converter is used to power all the 5 servos installed in LOTA.



#### **SAFETY!**

The converters have a built-in temperature sensor, which shuts down the power supply if overheating occurs. The converter is water-sealed and is shielded with a heat sink.



Fig. 14: Buck converter

#### Control board

Before using the control boards (Fig. 15), short circuits tests were performed to ensure their functionality. This can controls the manipulator servos, 2 Ethernet cameras, lasers, sensors and DC pump motor used in moving the water through the pipeline system to verify the correct flow.

#### Laser pointers

Eight 5mW laser pointers are setup in a rectangular frame surrounding the cameras as shown in Fig.16. The lasers are used as a reference to measure the real dimensions of objects such as the iceberg, the corroded pipeline, and the wellhead. The lasers are operated using ON/OFF switches (relays).



#### **SAFETY!**

Laser safety protocols were developed by Blue ROVotics. It is not permitted to operate the lasers except during mission execution. Otherwise, testing the lasers ashore or in the lab requires special procedures. A laser safety diagram is attached to the Appendix C.



Fig. 15: Real control board

#### Tilting system

An acrylic tilting system, powered by a servo motor, is designed to provide a full-view field during the missions' performance. Fig.17 represents the tilting system.

#### Network switch

A DLINK 5-port network switch (Fig.18) is installed to integrate Maestro module, thrusters-control cans and 2 cameras using Ethernet protocol. Previously, RS232 was used by the programming staff members in their former companies before they transfer to Blue ROVotics. Typically, the maximum length for an RS232 link without losses is 8m. Some ROV manufacturers stretch their RS-232 lengths up to 75-100m with huge signal losses. As such, the RS-232 protocol has proven to be length-limited and is typically only used in short runs at the surface or through the vehicle's telemetry system. Consequently, the RS-232 standard has been essentially changed to Ethernet by Blue ROVotics. Ethernet protocol is highly efficient as the length of the tether can be extended up to 100m without any data degradation. In addition, extra devices can be added to the network by only replacing the switch without any change in the circuits.

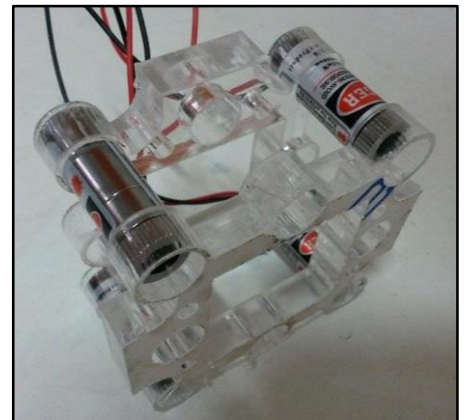

Fig. 16: Laser pointers with acrylic frame

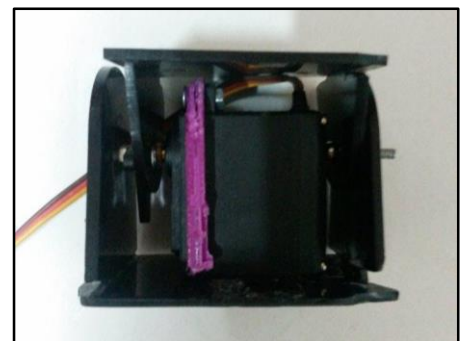

Fig. 17: Tilting system



### Ethernet-to-serial converter

Ethernet to serial converters are used in LOTA to interface the controllers and the Maestro module using Ethernet protocol (Fig.19).

### Thrusters-control cans

These are 2 major cans in the ROV, each of outer diameter 12cm and length 28cm. Each can encloses: 4 buck converters, 4 temperature sensors, 2 water sensors, 4 current sensors, 1 Ethernet-to-serial converter, network switch for additional cameras, and Maestro Module. The Ethernet-to-serial converter and network switch are similar to the aforementioned in the main-control can.

### Can conversions

Four 48V to 12V (20A) converters are used to power the thrusters. Each thruster consumes maximum current of 13A. A safety margin for current consumption (7A) is left to sustain a safe environment.

### Control boards

The control boards are in the form of a stack-like structure. The stack consists of several layers: each layer controls a separate thruster. This has proven to be efficient as any layer can be replaced immediately in case of failure. The control boards (Fig.20) are controlled by a Maestro module. The Maestros are Pololu's second-generation family of USB servo/brushless controllers. The Maestro's channels can be configured as servo/brushless outputs for use with radio control servos or electronic speed controls (ESCs), digital outputs, or analog/digital inputs; the Maestro is a highly versatile servo/brushless controller and general I/O board in a highly compact package. This has proven to be more efficient than using several microcontrollers to operate the motors. Instead, a very compact and small 24-channel Maestro module is placed to operate up to 24 devices. The extremely precise, high-resolution servo/brushless pulses have a jitter of less than 200 ns, making the Maestro well suited for high-performance animatronics, and built-in speed and acceleration control make it easy to achieve smooth, seamless movements without requiring the control source to constantly compute and stream intermediate position updates to the Maestro. Troubleshooting LEDs are used on each stack to ensure power connections. This can controls 4 thrusters, monitors temperature of each converter, monitors current consumption of each thruster and detects water leakage.

### Sensors and telemetry

#### AltIMU-10 v4 Gyro, Accelerometer, Compass, and Altimeter

The AltIMU-10 v4 (Fig.21 (a)) is a compact board that combines LPS25H digital barometer, L3GD20H 3-axis gyroscope, and LSM303D 3-axis accelerometer and 3-axis magnetometer to form an inertial measurement unit (IMU) and altimeter, which are the input values for a 3-degree-of-freedom stabilization algorithm (yaw, heave and pitch).



**SAFETY!**

The barometer is used to detect any leakage through the end caps of the electronics cans by constantly monitoring the pressure inside of the cans. Any major change in the pressure is directly reported to the co-pilot on the driving station GUI.



Fig. 18: Network switch



Fig. 19: Ethernet-to-serial converter

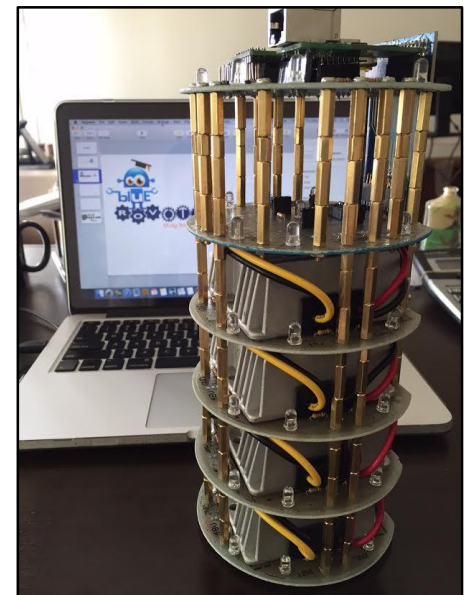

Fig. 20: Thrusters Control Stack Board

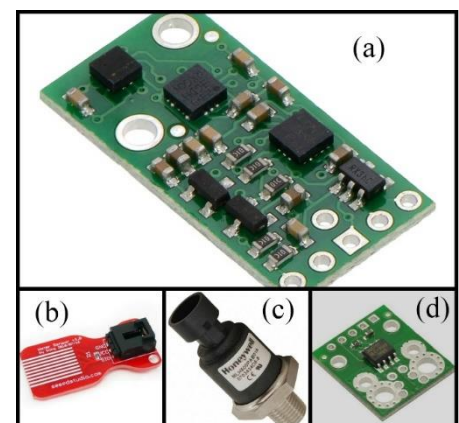

Fig. 21: Sensors





## TESTING!

In order to ensure the befitting of the selected hardware, the outputs of the sensors were tested in the pool at various angles and depths, which has proven that the sensors generate very accurate readings. This aided in creating a more reliable system with efficiently-performing algorithms.

### Water sensor

Six RB-See-199 water sensors (Fig.21 (b)) are installed and interfaced by the Mastero Module. The sensor outputs an analog signal according to the amount of water.



## SAFETY!

Two water sensors are installed in each tube, one at each end cap, to detect any water leakage, and inform the co-pilot by buzzing an alarm in the driving station.

### Honeywell pressure sensor

During processing, the pressure sensor's reading is calculated using the depth of the vehicle, taking into account the configurable water density and current atmospheric pressure. This measurement acts as feedback to an auto-depth function featured in the control system. Fig.21 (c) shows the pressure sensor.



## SAFETY!

An external housing is specially designed for the pressure sensor to completely seal it and prevent any leakage.



## TESTING!

The housing of the sensor was tested under pressure up to 2.5 bars (25.5m) and has proven complete sealing.

### LM35 temperature sensor

16 temperature sensors are installed, Four in each electronics can, to monitor the temperature of the cans and display it on the GUI. The sensor outputs a range from  $-55^{\circ}\text{C}$  to  $+150^{\circ}\text{C}$ .



## SAFETY!

Any rise in temperature above a certain user-defined threshold is automatically reported on the driving station GUI for the co-pilot to take the necessary actions.

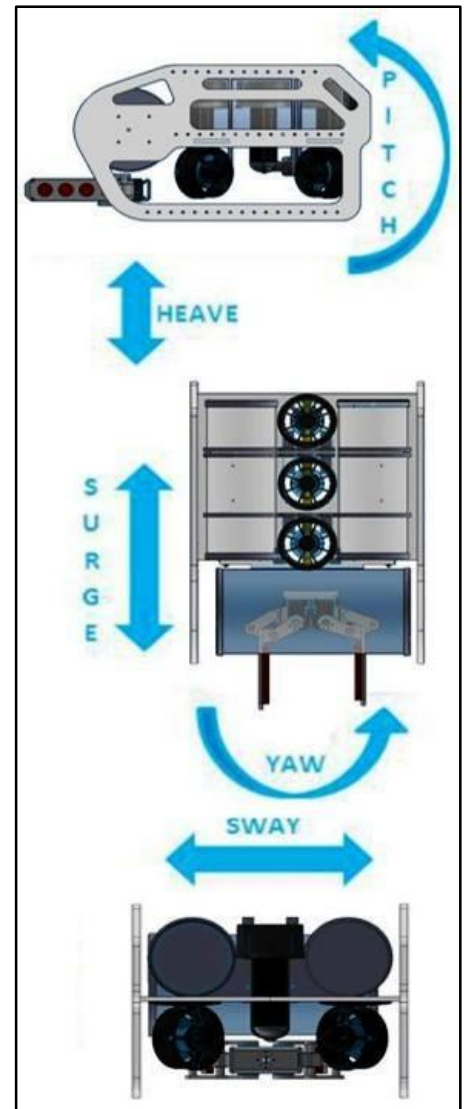

Fig. 22: Degrees of freedom of LOTA

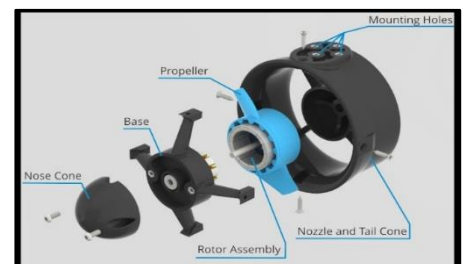

Fig. 23: SeaBotix & Blue Robotics thrusters

## Current sensor

An ACS711 current sensor (Fig.21 (d)) is designed for bidirectional input current from -25 to 25 A. Eight current sensors are installed in LOTA.



### **SAFETY!**

A current sensor is used to monitor the current of each thruster for safety. An additional sensor is used to monitor the current of the control system.

## Subsystems

### Thrusters and propulsion

LOTA is equipped with 7 Blue Robotics T100 brushless thrusters, which allow 5 degrees of freedom. Three thrusters, placed at the center of LOTA, are set for heave and pitch, and four thrusters for sway, surge and yaw shown in Fig.22 and Fig.23. These degrees of freedom ease the missions for the pilot as many objects need to be deployed with a certain angle such as the hot stab. This year Blue ROVotics focused on innovating new techniques rather than building its own thrusters, thus, the Blue Robotics thrusters have proven to be the most suitable option. The Blue Robotics thruster consumes maximum current of 12.5A and provides thrust up to 2.36kg.f, which is very efficient and enough to carry heavy weights (such as the acoustic sensor). Brushless motors have several advantages, including longer service life, less operating noise (from an electrical standpoint), and greater efficiency. Left and right propellers are distributed among the thrusters, rendering a more stable maneuvering than using only one type of propeller as shown in Fig.24. One of the special features of LOTA is the horizontal vector thrust. The thrusters' settings shown in Fig.25 provide an unobstructed flow of water for maximum efficiency. The graph in Fig.26 illustrates the thrust of T100 thruster against its current and power (maximum power = 160W).



### **SAFETY!**

A Kort nozzle is attached to each motor for safety reasons. In addition, Kort nozzles enhance the stream line of water flow through the motor. The efficacy of a Kort nozzle is the mechanism's help in reducing the amount of propeller vortices generated as the propeller turns at high speeds. The nozzle, which surrounds the propeller blades, also helps with reducing the incidence of foreign object ingestion into the thruster propeller. Also, stators help reduce the tendency of rotating propellers' swirling discharge, which tends to lower propeller efficiency and cause unwanted thruster torque acting upon the entire vehicle.

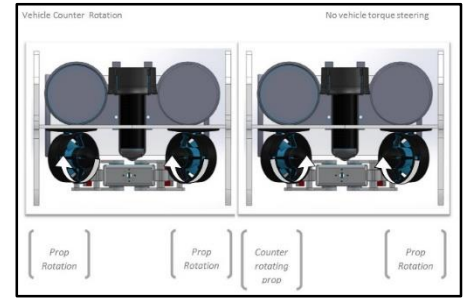

Fig. 24: Left and right propellers

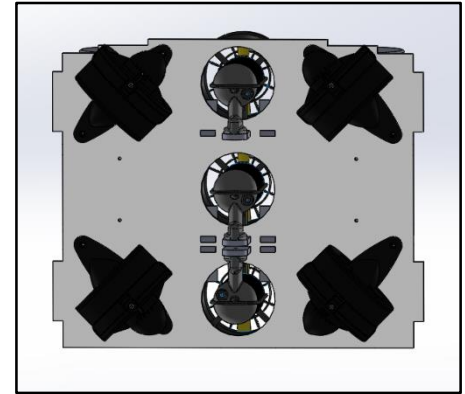

Fig. 25: Thrusters' setting

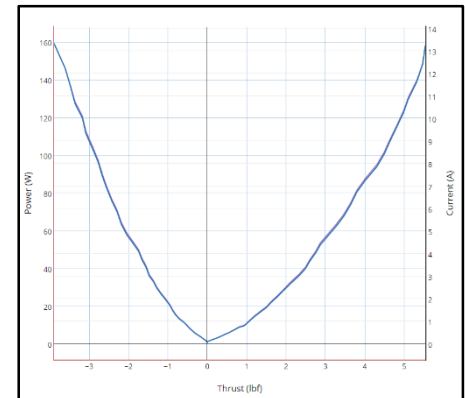

Fig. 26: Thrust - current/power graph



Fig. 27: Camera



## TESTING!

The maneuvering of LOTA was tested using the selected thrusters, which have proven to give enough thrust to carry heavy objects during missions' performance such as the acoustic sensor. This combination of thrusters also provides very stable maneuvering.

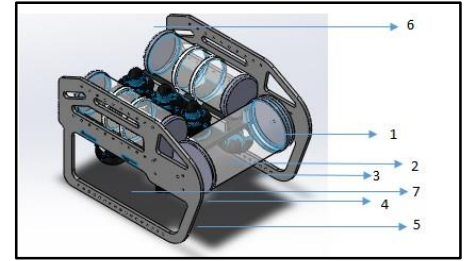

Fig. 28: Cameras Configuration

### Cameras

One of the primary aspects Blue ROVotics focused on while designing LOTA is to provide a clear and broad vision for the working area and the ROV's payload tools. Therefore, seven 1080P full HD IP network board cameras are installed (Fig. 27 & Fig. 28); to cover a very wide range of view field. Each camera supports 1920 x 1080 x 1536 HD resolution output and has a 170 degrees wide angle lens.

**CAM1 & CAM2:** Placed at the front of the ROV inside the electronics can. Attached to a chassis composed of a tilting system driven by a joystick-controlled servo, which, along with the wide angle, provides a full-field view during the missions' execution. Used during maneuvering, identifying sea stars, surveying the iceberg, conducting a CVI of an oil pipeline and repairing it, examining gauge dial, measuring all dimensions and pumping water through the pipeline system. Act as a base for developing stereovision algorithms in the future.

**CAM3 & CAM4:** Oriented to view the manipulators. Each camera is housed in a polyethylene container and fixed as a separate module to easily adjust its view angle (for CAMs 5, 6 & 7, the same sealing technique is applied). Used during all missions performed by the manipulator as removing the sea urchin, deploying the acoustic sensor, installing the galvanic corrosion detector, and handling the hot stab.

**CAM5:** Oriented to view the cross-block used in turning on/off the valves.

**CAM6:** Oriented to view the tether and the algae collector. Placed at the top of the ROV projecting from the floating body. Used during removing a sample of algae and during all the missions' time for the tether-man to monitor the tether.

**CAM7:** Oriented vertically downwards to view the mission's field under the ROV. This gives the pilot a clearer vision of the objects and a better location estimation.



## TESTING!

Each camera's housing was tested under pressure up to 2.5 bars to ensure complete sealing with a huge safety margin in a pressure chamber. The view angle of each camera was tested and set during maneuvering in the pool to have a clear image of the payloads and a full field view.

### Spot lights

LOTA is equipped with a pair of high-power spotlights, in order to maintain clear vision during the performance of the required missions in dark conditions inside of the ice tank. The light intensity is the maximum at the air sea interface and decreases gradually as the ROV dives deeper into the water eventually reaching zero at almost 20m under clear sky conditions, as presented in Fig. 29. Consequently, the spotlights are essential elements for the ROV to be more applicable. Each spotlight is well-sealed inside a brass casing. Brass was a primary choice for the spotlights as high-power LEDs emit a big deal of heat energy as shown in Fig. 30, hence brass has proven to be an efficient heat sink. Brass has several advantages, as it can be readily machined, has an excellent thermal conductivity making it a first choice for heat exchangers, and is resistant to corrosion. To make the casing more efficient, circular grooves are constructed to increase the surface area to which the water flows, so more cooling occurs, due to increased heat transfer by conduction and convection.

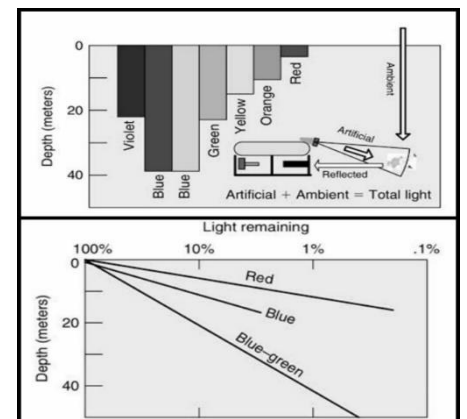

Fig. 29: Light penetration & total illumination



The lighting aboard an ROV system blinds the camera through backscattering of light hitting the particulate matter suspended in the water column as shown in Fig.31. In highly turbid water conditions (such as in most harbors around the world), reduction of the lighting intensity may be necessary in order to gain any level of visibility. Hence, the spotlights are operated using a Pololu H-bridge to control the illumination according to the water's turbidity. Another consideration to aid the viewing of items underwater is the separation of the light source from the camera, so that the water column before the camera is not illuminated, thus eliminating the source of backscattered lighting. Consequently, each spotlight is placed 7cm away from the camera proving, after several experiments, to be wide enough to supply a clear image.



**SAFETY!**

The metallic housing acts as a heat sink to cool the spotlights to avoid overheating.



**TESTING!**

The spotlights setting was tested and adjusted in very dark conditions to give a very clear image.

**Control station**

The control station (Fig.32) is divided in to 3 main units: driving unit, missions unit, and display unit. The driving unit consists of a THRUSTMASTER (T.Flight Hotas X) plug-and-play joystick. The joystick sends its commands to LOTA through a laptop, which integrates the driving unit and the missions unit. The laptop displays the joystick's and the ROV's states through a GUI. The missions unit consists of a C# software program specified for all the mission, and an LED display board to determine the points subjected to galvanic corrosion along the leg of an oil platform by detecting the voltage across them. The display unit consists of two 18-inch screens for the Ethernet cameras' display and a TP-Link wireless router. The screens display the images of all the cameras by switching between them through the laptop. The router's main function is to act as the basic step for implementing drive over IP by connecting to the ROV's camera platform through a web browser installed on any gadget. This facility is used by the tether-man to monitor the tether in invisible/dark places (such as under ice in task 1) on a mobile phone through a specialized camera. The control station plugs are shown in Fig.33

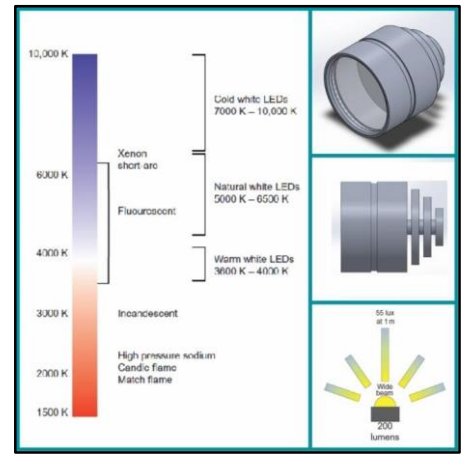

Fig. 30: Spotlights' housing and high power LED

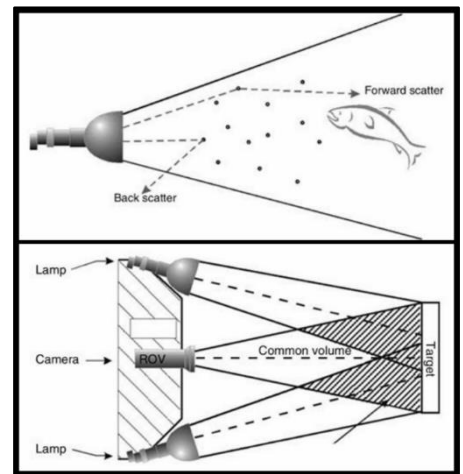

Fig. 31: Scatter phenomenon



Fig. 32: Control station prototype

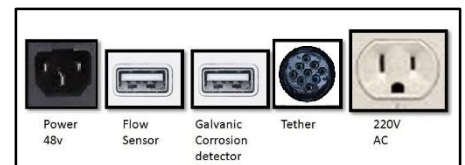

Fig. 33: Control station plugs



### **SAFETY!**

The control station has a programmed safety section and an auto-shutdown system for any emergencies (check software). A safety button for system power-off and a main 40A fuse are installed in the control station. All the power plugs are covered and all the wires are secured tightly. An I/V sensor is used to monitor and display the voltage and current consumption of LOTA.



### **TESTING!**

After the control station was built, the whole system was tested in the pool to ensure effectual safety alarms, driving unit, missions unit and display unit.

## Manipulator

Two parallel-jaw polyethylene grippers are designed and installed to LOTA to complete the mission tasks (Fig.34). The primary advantage of a parallel jaw is how the prehension force is always constant over the length of the jaw and this force is always normal to the face of the jaw and thus it has the potential to grasp a greater variety of objects securely. For each manipulator, the fingers of the jaw are driven by a 10kg.cm water-sealed servo. Each manipulator has a manually-controlled revolute joint, which allows rotary motion. This rotary motion allows the manipulator to rotate clockwise or anticlockwise, thus the jaw can operate horizontally or vertically, which has proven to significantly ease the missions for the pilot. The manipulators are used in removing sea urchin, deploying the passive acoustic sensor, attaching the lift line to the corroded pipeline, pulling 2 pins of the pipeline, installing the flange adapter and the bolts, repairing the wellhead, inserting the hot stab, and installing the flow sensor and the galvanic corrosion detector. The idea of having 2 manipulators has proven to shorten the missions' execution time, as the pilot doesn't have to ascend and descend to and from the surface many times. Instead, the ROV can hold more than 1 attachment at a time.

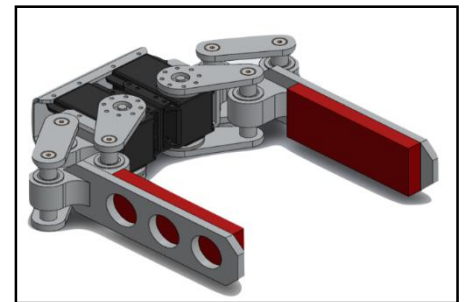

Fig. 34: Manipulator



### **SAFETY!**

The manipulator servos have a separate converter to avoid any system failure if current drainage increased due to jamming.



### **TESTING!**

The manipulator's degrees of freedom were tested with different angles to ensure easy mission completion.

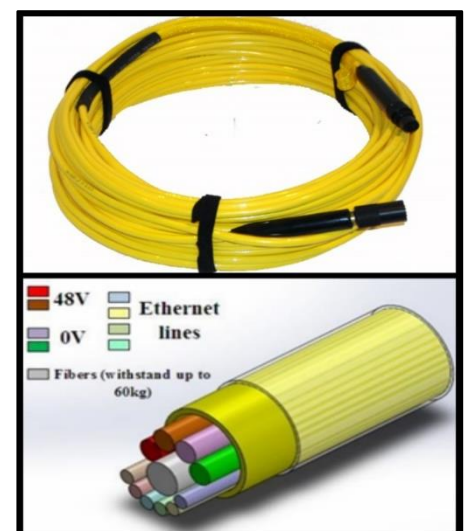

Fig. 35: Tether and its lines

## Tether system

LOTA is tethered with a 25m VideoRay tether. The tether weighs 1.77kg and has a diameter of 1.5cm. The relations between the tether drag, the speed, and the diameter are illustrated in Fig.36. The coefficient of drag of cables ranges from 1.2 for unfaired cables; 0.5-0.6 for hair-faired cable; and 0.1-0.2 for faired cables which depends on the diameter of the cable. Since the cylindrical form has the highest coefficient of drag, the use of cable fairings to aid in drag reduction can have a significant impact. Therefore, Blue ROVotics managed to reduce the coefficient of drag of the tether by the diameter reduction. Designed to be neutrally buoyant in fresh water, the tether has a polyurethane outer jacket coating of low drag. The tether lines are distributed as shown in Fig.35. The tether is terminated at the topside end with an Ethernet and power plugs. The tether power and voltage drop were calculated as shown in Fig.37. The voltage drop across the tether is 4.91V, so the voltage reaching the converters (43.09V) is high greater than the converter's voltage limit (36V) for proper conversions.

## Slip-ring tether deployment system (STDS)

The ROV umbilical is handled by a manual winch system that connects to a STDS shown in Fig.38. The usually neutrally buoyant tether connects the ROV to the STDS, which pays out or takes in the tether as the operator dictates. With the slip-ring system, an electrical rotary joint is embedded within the subsea tether drum, allowing for orderly tether payout/take-up which lessens tether wear (but adds a level of complexity due to the rotary joint).



### **SAFETY!**

Tether always rolled on the STDS to prevent any tangling or trapping.

## Payload tools

Apart from the manipulators used in completing the missions, six additional payload tools are designed and installed in LOTA to aid in finishing the missions proposed by MATE.

## Galvanic corrosion detector

A cylindrical frame (Fig.39) is designed with metallic stripes connected to an LED board in the control station and powered by USB. The stripes connect with the inspected spots and the LED lights up if there is any voltage difference, thus detecting the chance of galvanic corrosion.

## Cross-block

A polyethylene cross-block shown in Fig.40 is designed to be attached to a 14kg.cm continuous waterproof servo motor placed at the bottom of the ROV to open/close the valves of the pipeline system.

## Flow sensor

A flow sensor (Fig.41) is designed using shaft encoder to be deployed in the flume tank for a 5-minute period to measure the average water flow.

## Christmas-tree water pump

LOTA is equipped with a 14A/12V DC 3700 GPH bilge pump shown in Fig.42 in order to create high pressure strong enough to move the water through the pipeline system to verify the flow of water through the correct pathway. The pump is placed in a front-centered position of LOTA.

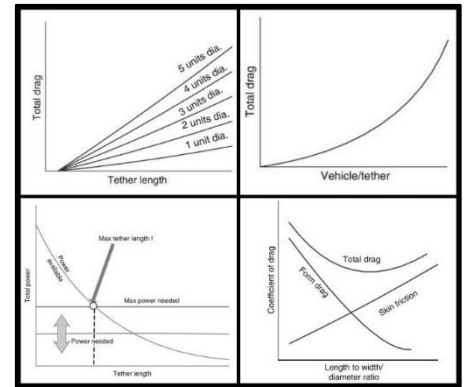

Fig. 36: Tether drag graphs

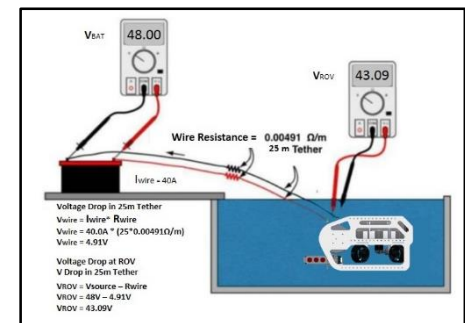

Fig. 37: Tether voltage drop

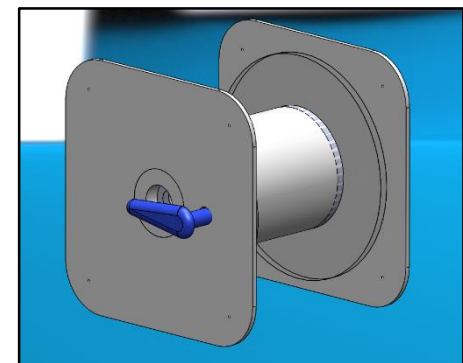

Fig. 38: Tether deployment system mechanism



Fig. 39: Galvanic corrosion detector



## Algae collector

The algae collector is composed of a cylindrical tube which acts as the house in which the algae rests. Inside the tube, a 12V pump is installed to suck the algae and keep it in place during the motion of LOTA. The algae collector is placed at the top of LOTA projecting from the floating body.

## Lift line

A one-way mechanism Fig. 43 is designed for the lift line using LEGO tires, beams and rubber bands. This mechanism has proven to firmly hold the pipeline without releasing it.

## Software

The software developers of Blue ROVotics have developed a control system for LOTA based on Microsoft's .NET framework and C# object-oriented programming language, a client-server interface is setup using Adobe Illustrator and Windows Forms Applications. The control program of LOTA consists of 5 tabs: sensors and control, measuring dimensions, Science under the Ice, Offshore Oilfield Production and Maintenance, and match progress. The code flow chart is attached to Appendix B.

Ethernet protocol is used in LOTA's communication. TCP protocol-which acknowledges receiving the data thus ensuring the correct transfer of data, is used for data exchange between LOTA and the driving station. However, UDP protocol is used to interface the Ethernet cameras; because the TCP slows down the camera streaming due to the acknowledgement process which is not needed for the cameras as the error rate is negligible for videos (Fig.44).



### **SAFETY!**

A safety section is visible in all the tabs to ensure that the crew is aware of LOTA's state during the operation time. If any emergency occurs, pop-up alarms with visual aids appear to warn the crew. The section includes water leakage, cans temperature and pressure, and motors' currents. The match timer and an additional timer are also visible in all the tabs to keep track of the remaining missions' time and the 5-minute period of flow sensor deployment.



### **TESTING!**

The idea of creating special tabs to aid the crew in completing the missions has proven after testing to reduce the missions' time and errors.

## Sensors and control

This tab interfaces the joystick (Appendix B) and then sends its commands to the thrusters, has a 3-degree-of-freedom auto-stabilization control algorithm to adjust LOTA inside of the flume tank due to current, and contains a GUI on which the sensors' readings are displayed. The auto-stabilization is implemented in yaw, pitch and heave (depth) directions by our embedded system programmer. After determining the parameters of the controller on Matlab Simulink, the contours were coordinated by writing an algorithm to calculate the thrust of motors. This dynamic positioning system reduces the

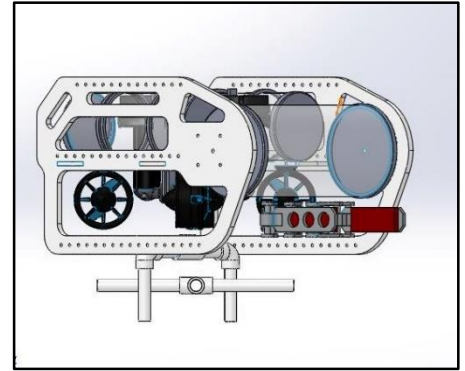

Fig. 40: Cross block



Fig. 41: Flow Sensor



Fig. 42: Searle 3700 GPH 12v Bilge Pumps (3700gph 12v, 14A)



Fig. 43: Lift Line

impact of waves (engineering basin in task 2 and flume tank in task 3) during the mission performance by allowing the ROV to maintain its heading. The GUI consists of several widgets: gyro, compass, accelerometer, depth and pressure. Important information is always clearly visible for the pilot. This software periodically provides data exchange between ROV and widgets to be displayed for the pilot. This GUI has proven to be quite handy and convenient to use during the training sessions. It's quite visually, informative and handy. The design layout of the GUI is shown in Fig.45.

### Measuring dimensions

In this tab (Fig.46), the dimensions of the iceberg, corroded pipeline and wellhead are measured with very high accuracy. The camera is interfaced using DirectX library. The distance between the 2 laser pointers is taken as the reference. The real dimension is calculated by applying a ratio between the number of pixels and the real distance.

$$\text{Measured object} = \frac{\text{object pixels} * \text{laser reference}}{\text{laser pixels}}$$

A video recording button is also included for surveying the iceberg.

### Science under the Ice

This tab (Fig.47) aids the co-pilot in completing the tasks in mission 1. The tab is divided in to 2 sections: Sea Stars and Iceberg. Photos of all sea stars and their species are displayed with two counting buttons, for each star, used to change the count by few clicks. The second section is dedicated to calculating the threat levels of the ice berg.

### Offshore Oilfield Production and Maintenance

The average flow rate of the deployed sensor is displayed in this tab over a 5 minute period and a graph is produced. The GUI of this tab is shown in Fig.48.

### Match progress

The last tab (Fig.49) is designed to display the missions according to the company's strategy in order to calculate the score of the accomplished missions by selection, which helps the pilot and the co-pilot keep track of their progress and scoring throughout the match.

## Safety

### Policy statement

Blue ROVotics staff managed to design and follow some safety precautions in order to avoid injury and stay safe throughout the whole working duration. We prefer not to be safety blinded but safety minded.

### Staff safety

Blue ROVotics has a specialized ergonomics director, Zeyad Medhat, and safety officer, Sondos Omar. The ergonomics director designs safety instructions and protocols, whereas the safety officer supervises the commitment to these precautions to ensure the utmost safety of every member of the company. The ergonomics director and the safety officer managed to provide the staff members with safety training according to Oceaneering safety handbook and OSHA precautions recommended by MATE center (Fig. 50). Lab protocols were developed and hung as reminders in our workshop as shown in

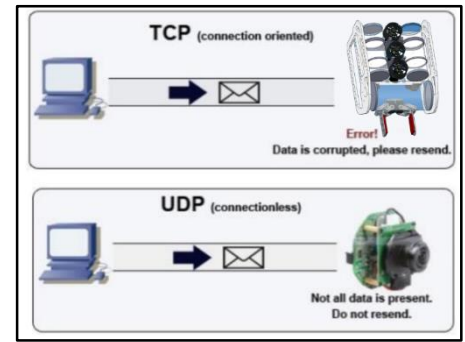

Fig. 44: TCP Vs UDP

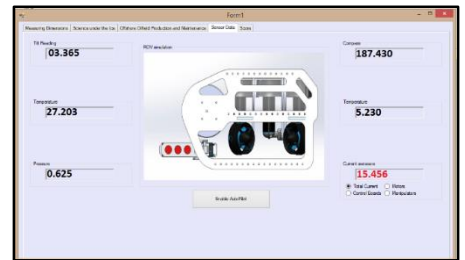

Fig. 45: Sensors and control

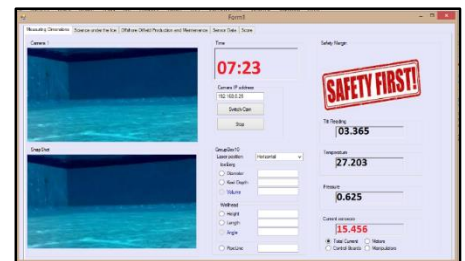

Fig. 46: Measuring dimensions

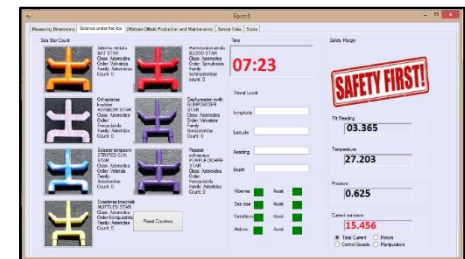

Fig. 47: Science under the ice

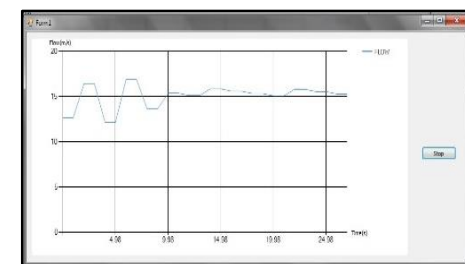

Fig. 48: Offshore oilfield production & maintenance

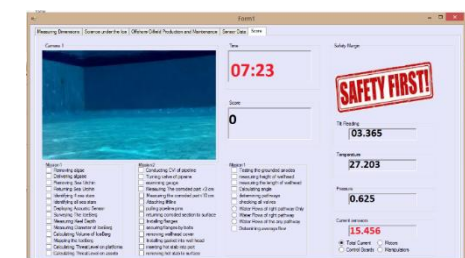

Fig. 49: Match progress

Fig.51. Fire emergency equipment are hung beside the lab door for any emergencies. Lab safety was sustained through:

- Wearing eye goggles during cutting and building the mechanical body. (Fig.52)
- Using a well-closed laser-cutting machine. (Fig.52)
- Using fixed tools, like the drill station instead of the drill to avoid any injuries. (Fig.52)
- Wearing gloves and lab coats while printing and welding the electric boards. (Fig.53)
- Wearing ear blockers while using the saw station to block its high sound from the user. (Fig.53)
- The workshop contains a first aid box for any injuries.
- Wear closed toe shoes inside the workshop.
- Carry the ROV from its handle only.
- Wearing laser safety glasses. (Fig.54)
- All equipment have safety stickers and are stored in safety toolboxes. The toolboxes are kept in a storage room separate from the workshop. (Fig.55)

Public safety is our concern too, therefore, public awareness laser signs are prepared to warn public of laser operation. A copy for the fire emergency, lab protocols, laser safety, electrical safety and housekeeping precautions are attached to Appendix C.

### LOTA's safety features

As safety comes number one, LOTA has numerous safety features to keep the crew, ROV, and work environment safe during operation. Apart from LOTA's safety features discussed in the previous sections, a safety trolley (Fig.56) is used for easier transportation of the ROV and the control station. Concerning the staff, this reduces the risk of falling and back problems, and additionally protects the ROV from breakage.

### Safety checklist

A safety checklist was developed by our safety staff stating the necessary procedures to be taken before launching and retrieving the ROV. Special procedures are designed for the tether-man to ensure his safety during operation. Emergency instructions are also thought of in case of leakage detection or connection loss. A copy of the safety checklist is attached in Appendix C.

### Future improvements

Always seeking improvement, Blue ROVotics staff members are willing to implement some future improvements in designing and building their ROVs in the future as well as managing the work plans.

### Technical

#### Mechanical

- Using a hydraulic manipulator with six degrees of freedom.
- Developing company's thrusters with improved sealing.

#### Electrical

- Using a fiber optic tether which is lighter, thinner and allows very fast data transfer. In addition, it is not affected by noise and data can travel through it very large distances without attenuation. This will



Fig. 50: Safety Session by Sondos and Zeyad



Fig. 51: Blue ROVotics workshop

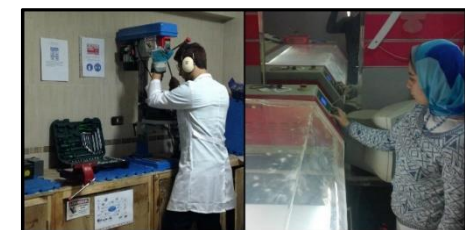

Fig. 52: Ahmed drilling the end cap and Sondos using laser-cutting machine



Fig. 53: Ahmed cutting copper board and Zeyad printing the board



significantly reduce the diameter of the tether and therefore reduces the drag force on the tether. Consequently, improving the maneuverability of the ROV.

- Using stereovision by installing 2 cameras to measure the distances through the software with further accuracy.
- Developing an embedded control system controlled by a real time operating system (RTS) for better traffic management to reduce system overhead.

#### Software

- Measuring dimensions using stereovision algorithms.

#### Budget

In the planning process, our CFO had to estimate a budget based on the materials selected. However, our estimated budget was \$1,100 more than the total actual cost of LOTA. This difference was due to the discount, our marketing director got, of the VideoRay tether and Blue Robotics thrusters. The expected budget and project costs are attached in Appendix D.

#### Troubleshooting

After the first assembly of the ROV, Blue ROVotics started testing the isolation in a swimming pool at a depth of 7m. An infinitesimal amount of water was detected leaking in the electronics can. Consequently, using a compressor, every part of the ROV was checked by blowing air through it, and any out-coming air bubbles in the water were being noticed. The reason of the problem was immediately identified, as one of the SeaBotix motor wires leaked some water. After several trials with covering the holes with epoxy and heat shrinks, the wires were totally isolated, and no leakage occurred.

#### Challenges

##### Technical

##### Measuring Dimensions

For the sake of reducing the mission time, an idea was proposed to measure the dimensions through the C# software with few clicks, which was a major challenge to Blue ROVotics. At first, the laser-reference technique did not work, and would give inaccurate results as the lasers needed to be perfectly parallel and focused. A new frame for the lasers was designed and cut by a laser-cutting machine to completely incubate the lasers and eliminate any slight deviation between them. After several experiments with images captured from different angles and distances, the software gave highly accurate results. Further trials were made to ensure the accuracy of this technique, proving its precision with uncertainty of 1cm maximum.

##### Non-technical

A month earlier, the media director quit which was such a predicament for the uncompleted designs. A catastrophe was expected in the timeline, yet we fortunately managed to figure it out. An immediate meeting was held, where a couple of suggestions were proposed. Renting a designer seemed to be the most convincing, however, we adjudicated that the web designer would take a share of the work, and the rest was divided among us. But what drove this worse, was the web designer leaving for private circumstances, which added to Blue ROVotics' rest of employees extra working hours for self-learning to get the job



Fig. 54: Nouran and Ahmed working with laser



Fig. 55: Storage Room



Fig. 56: Safety trolley



Fig. 57: SAFETY swag!

done. The designs and media work were divided among all the staff, each having the closest possible job to his original work. For example, web designing contains a bit of programming thus the programming staff managed to learn and establish a web site from scratch while the mechanical staff started suggesting and implementing designs for the poster display required by the MATE center which is also close to their job of trying ideas for the mechanical design. It was expected that things don't go according to the plan, however, all the non-technical work was surprisingly finished in time without any delay.

## Lessons learned

### Technical

#### Parallel-jaw gripper

The parallel jaw gripper uses a parallelogram shaped structure to keep the jaws parallel to one another. The gripper consists of two main sections: The gripper module, and rotational wrist module. Each is independent and can be assembled separately, and full 360 degrees continuous wrist rotation is an exceptional feature which can deliver up to 6 Nm torque.

There is more than one method for actuating the gears:

- A geared mechanism: rotational motion would be maintained from the motor to the jaw linkage. The challenge with this is that gripper is designed to be compact and thus its linkages and mechanism are internal
- A worm gear solution if combination of worms and gear are not limited
- Yet of all the possible linear to rotary mechanisms researched, the clip lever drive seemed to be the most viable solution

### Non-technical

In ROVotics, we care about the employees in the first place; because we believe that a job is done better when done with passion. We have learned to take after each other and our coach have provided us with the support that in turn, created the spirit of a family among us.

#### Cost management:

Blue ROVercs' employees are ex-employees for previous ROV companies, and thus during the brainstorming meetings, we did not only share ideas, but also the fruit of our previous experiences, including possible financial complications, aspiring avoiding last minute crashes. One of the strategies was focused on maintaining the cost management, which our CFO successfully, along with the employees that have an experience in finance achieved, in order to keep our budget suitable with respect to the amount of donations which our company received.

## Reflections

"It's what you learn after you know it all that counts", Blue ROVercs widened my horizons and pushed me into developing my technical, and social skills. The collaboration renders nothing a tough nut to crack. Technical wise, my capabilities in making estimations and expectations based on calculations in early stages have taken a leap. *~Maha Moustafa*

"This year I had the chance to apply the theories I had previously learned from my former company. Also, I found myself motivated to push myself to the edge and never be biased to my opinion because of the collaborative team spirit. It was definitely a fun and new experience to have a one-week piloting training, which was held by Blue ROVotics before the pilot's selection." *~Zeyad Medhat*



Fig58: Work process!

## References

1. Advantages of polyethylene and acrylic  
Title: Underwater robotics, ISBN-10: 0984173706, Author: Steven W. Moore
2. Ratio between length-to-width, center of buoyancy, tether pull point, Kort nozzles, RS-232, tether, TMS, spotlights, Manipulator  
Title: ROV Manual, ISBN-10: 0080982883, Author: Robert D. Christ
3. Left and right propellers  
URL: <http://www.boatfix.com/how/props.html>
4. Mastero Module  
URL: <http://www.pololu.com/docs/pdf/0J40/maestro.pdf>
5. Water sensor  
URL: <http://www.robotshop.com/ca/content/PDF/datasheet-elb145d2p.pdf>,
6. Temperature sensor  
URL: <http://www.ti.com/lit/ds/symlink/lm35.pdf>
7. Current sensor  
URL: [www.pololu.com/file/download/ACS715-Datasheet.pdf?file\\_id=0j197](http://www.pololu.com/file/download/ACS715-Datasheet.pdf?file_id=0j197)

## Teamwork

To beat the clock, Blue ROVotics staff has setup a full working system and schedule from the first day of work. At first, a missions' chart was created and hung in the workshop by our Ergonomics director for design and safety discussions (Fig.59). The research and development committee then started doing research and proposing ideas for the project. Once Blue ROVotics settled on the design choices, a "JOB" chart with all the tasks was block-diagrammed as shown in Appendix E to have a clear image of the whole process. In addition, a Gantt diagram was scheduled in detail after making a general flow chart for the work progress Fig.60, to be the company's timeline through the coursework (Appendix E). To arrange the working process and the order of tasks, a weekly-updated priority matrix (Appendix E) was created for each department in order to determine the order and duration of each task. Before starting any implementation, safety stickers with lab regulations were printed and hung all around the lab to remind the staff with the safety measures and any special requirements they need to follow during the course work. In order not to have a stitch in time, a weekly To-do list was hung in the workshop so that if any delay occurred it would not affect the whole time plan. On a weekly basis, a meeting was held so each department explains its work to other members and the logistics director discusses the general progress rate. This helped to ensure that the ROV was completed with as much time to practice before the competition as possible. A 5-minute meeting was held each time before work to organize the tasks through the day. The report content was divided among the whole staff and revised by the technical writing director.

## Outreach

We believe in beginning where others stopped, and hence we are always in quest for pioneering through developing and innovation. Assisting other companies is one of Blue ROVotics' activities, for we are not after competition, but rather development. Additionally, we have visited SeaPro ROV Company and talked with the CEO, Captain Tarek Farouk who made us a presentation about the various types of ROVs and the problems they would face during work. In addition, Blue ROVotics manages to hold orientation sessions about ROVs and underwater technologies for high school students to engage them in this field (Fig. 61).



Fig. 59: Zeyad reviewing the missions

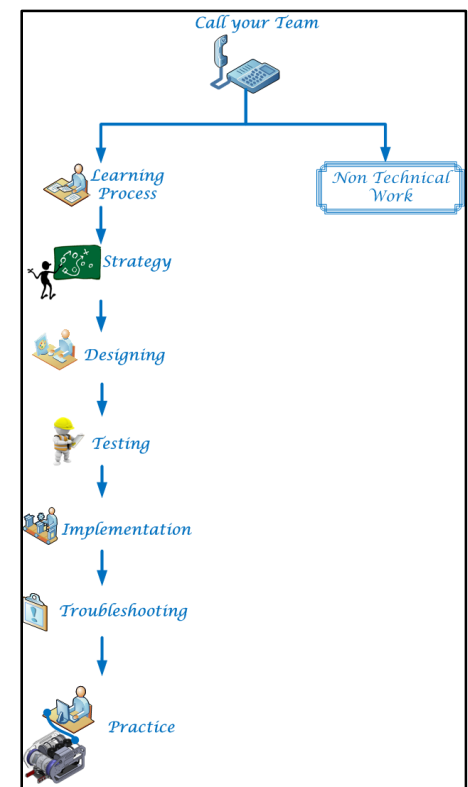

Fig. 60: Work flow



Fig. 61: Ahmed and Maha during orientation sessions



# Appendices

## Appendix A (Electrical System)

### System Interconnection Diagram

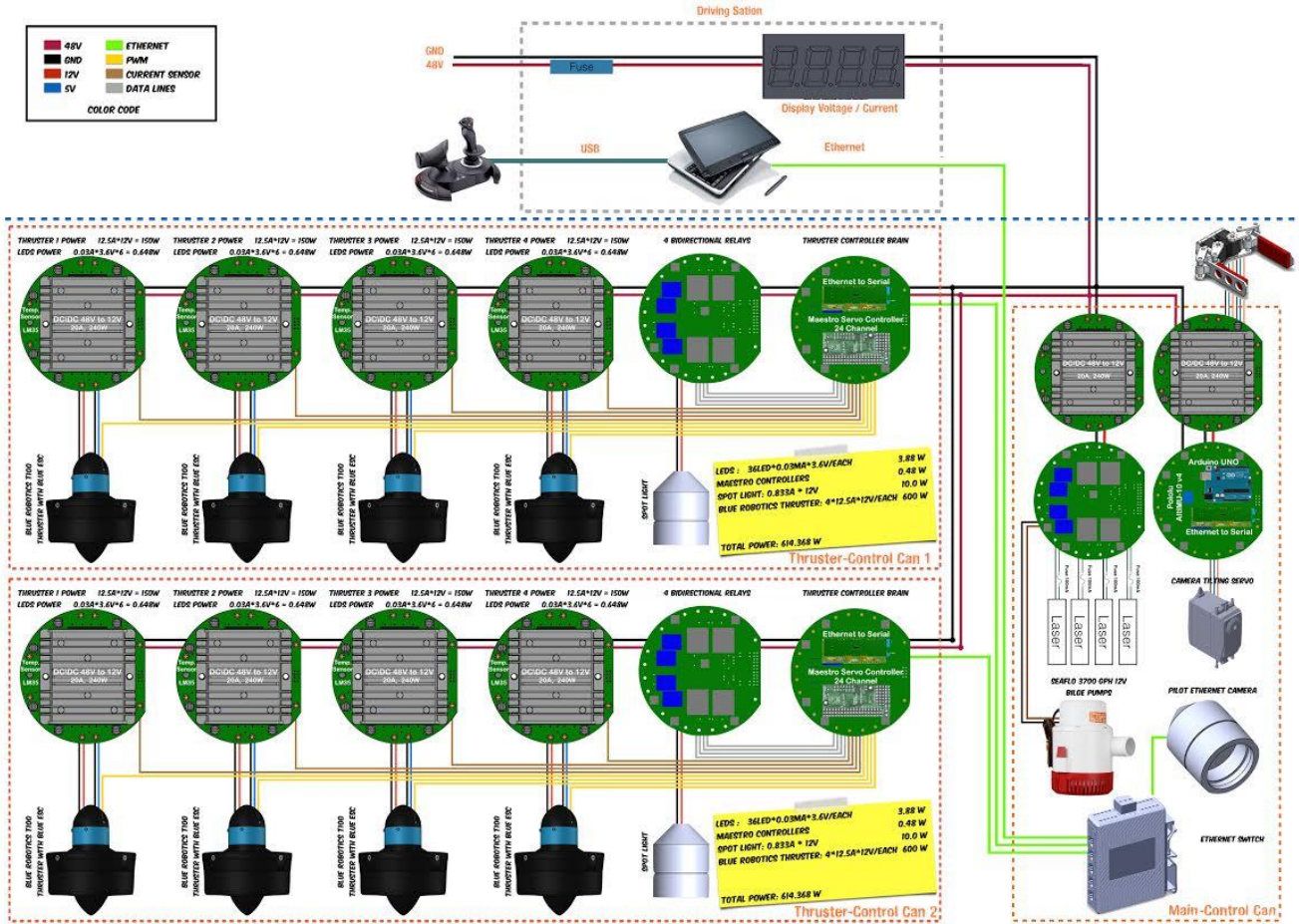

## Appendix B (Software)

### Joystick interface

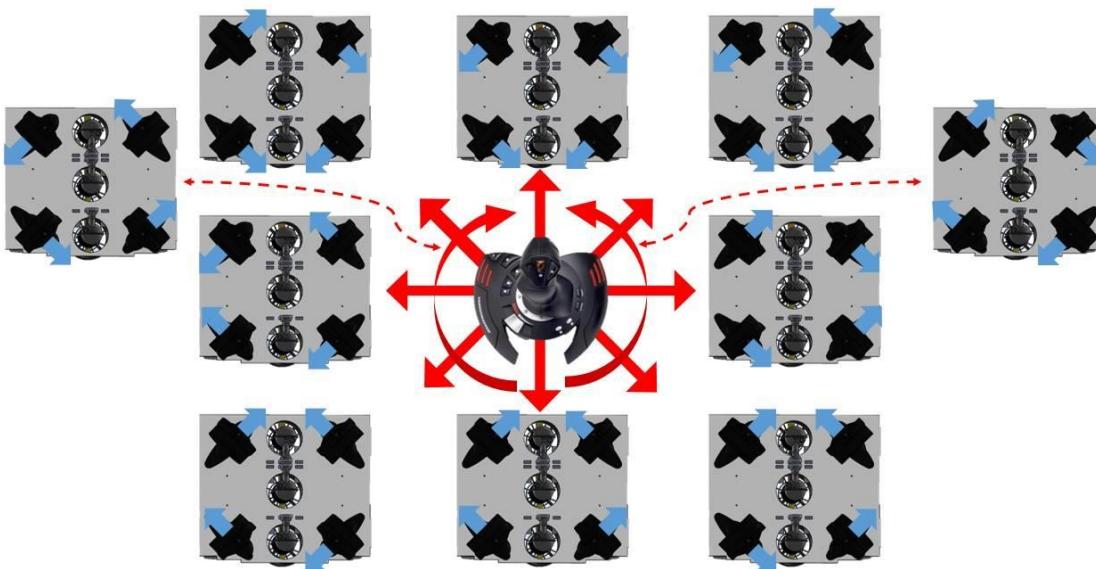

Flow chart diagram

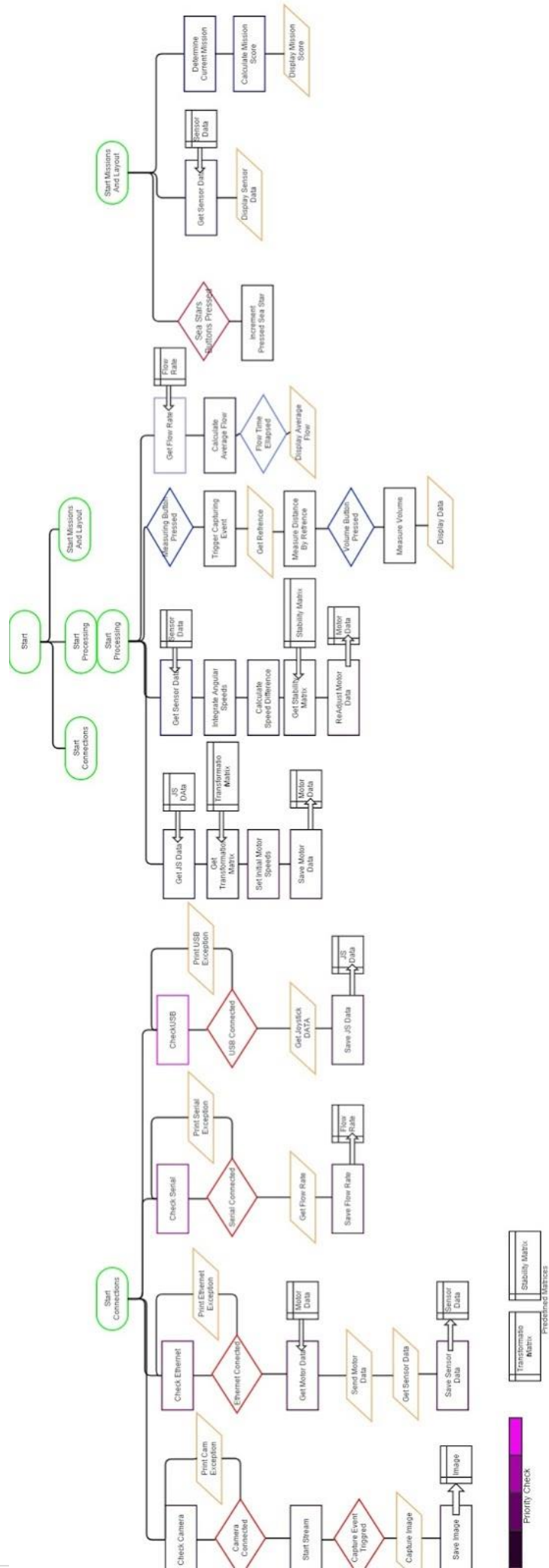

## Appendix C - Safety Checklist

Launching:		Retrieving:	
✓	Tether-man has access to the proper personal protective equipment to protect them from – safety officer	✓	Power off the ROV – pilot calls
✓	Tether-man puts on waist bag and ensures all tools which might be needed are packed	✓	ROV technician responds “ ROV is safe to retrieve “
✓	Tether-man secures the mobile phone for tether monitoring with arm phone holder	✓	<b>Leakage detection:</b>
✓	Area is clear from any tripping hazards – safety officer	✓	Pilot calls to Power down the ROV
✓	Operation technician checking that All power is switched OFF	✓	Retrieve with the tether
✓	The tether is connected to the ROV	✓	<b>In case of no connection:</b>
✓	All cables are Isolated	✓	Power down the ROV
✓	48V DC volt isolated	✓	Retrieve the tether
✓	No one is touching the ROV before power is ON	✓	<b>In case if connection restored:</b>
✓	The controlling joystick is at zero position	✓	Make sure there is no leakage
✓	All the components are securely attached to ROV before operation.	✓	Resume your normal operation
✓	No one is touching the thrusters	<h1>Successful trial!</h1>	
✓	The tether is moving freely		
✓	Pilot calls to power up the ROV		
✓	Ready to launch		

## Safety Diagram





## Appendix D (Budget)

Expected Budget:

Estimated Budget			Estimated period
Company Name: BLUE ROVotics			From: 01-12-14
University: Arab Academy for Science, Technology and Maritime Transport			To: 01-02-2015
Instructor: Kareem Youssri			
Items	Description	Notes	Amount
Converters	10 20A DC to DC Converters 48V to 12V	Used as a step down converter	\$ 280.00
Thrusters	10 T100 Thrusters	Used for yaw movement	\$ 1,400.00
Ethernet to Serial	4 RS232 serial to Ethernet converter tcp/ip module	Used to convert signals	\$ 110.00
Servo Motors	5 Servo motors	Used for arms	\$ 100.00
Polyethylene	Polyethylene Sheets and end caps	Used for fixing thrusters and isolation	\$ 250.00
Sensors	Sensors (AltIMU-10, Temperature, Current and Water sensors)	Used for monitoring the ROV	\$ 130.00
Shipping	Estimated shipping for Items		\$ 300.00
Components	Electrical components	Used for control system	\$ 100.00
Insulation materials	Rubber O-rings, Epoxy and heat shrinks	Used for sealing	\$ 35.00
PVC	PVC pipe and connectors	Used for building the mission field	\$ 50.00
Tether	2 Video ray tethers	Used for the tether	\$ 1,000.00
Mechanical Tools	Screws, drills, nuts and bits	Tools used for building the ROV	\$ 200.00
Board	PCB board	Used for mounting electrical components	\$ 40.00
Acrylic	2 Acrylic tubes of diameters 10cm and 14cm	Used as electronics cans	\$ 250.00
Safety Equipment	Laser Safety Glasses, gloves and eye protector	Used while working	\$ 20.00
Joystick	JoyStickThrustmaster Tflight Hotas X Flight Stick	Used for driving	\$ 300.00
Wasted Materials	Components wasted	Wasted while working	\$ 50.00
Machine Rent	3D Printer, CNC and turning	Used for cutting and printing the arm	\$ 80.00
<b>Total Estimated Budget</b>			<b>\$ 4,695.00</b>

Real Costs:

PROJECT COSTING							Reporting period
Company Name: BLUE ROVotics							From: 06-12-2014
University: Arab Academy for Science, Technology and Maritime Transport							To: 15-02-2015
Instructor: Kareem Youssri							
Date	Type	Expense	Description	Sources/Notes	Amount	Running Balance	
<b>Electrical Category</b>							
06-12-14	Donated	Converters	10 20A DC to DC Converter Voltage 48V to 12V	Used as a step down converter donated from Notions Co.	\$ 200.00	\$ 200.00	
14-12-14	Purchased	Thrusters	10 T100 Thrusters	Used for yaw movement	\$ 1,352.00	\$ 1,552.00	
15-12-14	Purchased	Ethernet to Serial	4 RS232 serial to Ethernet converter tcp/ip module	Used to convert signals	\$ 104.70	\$ 1,656.70	
29-12-14	Purchased	Board	PCB board	Used for mounting electrical components	\$ 21.50	\$ 1,678.20	
29-12-14	Purchased	Components	Electrical components	Used for control system	\$ 198.70	\$ 1,876.90	
14-01-15	Purchased	Laser	10 Laser pointers	Used for measuring distance	\$ 28.57	\$ 1,905.47	
15-01-15	Purchased	Servo Motor	5 Servo motors	Used for arms	\$ 140.00	\$ 2,045.47	
20-01-15	Purchased	Sensors	Sensors (AltIMU-10, Temperature, Current and Water sensors)	Used for monitoring the ROV	\$ 124.29	\$ 2,169.76	
<b>Hardware Category</b>							
20-12-14	Purchased	O-rings	Rubber O-rings	Used for sealing	\$ 32.75	\$ 2,202.51	
22-12-14	Purchased	PVC	PVC pipes, Tees	Used for building the mission field	\$ 51.75	\$ 2,254.26	
24-12-14	Purchased	Tether	2 VideoRay tethers	VideoRay has provided us with a 92% discount	\$ 77.00	\$ 2,331.26	
10-01-15	Purchased	Acrylic	2 Acrylic tubes of diameters 10cm and 14cm	Used as electronics cans	\$ 200.00	\$ 2,531.26	
13-01-15	Purchased	Safety Equipment	Laser Safety Glasses	Used for testing laser	\$ 11.00	\$ 2,542.26	
15-01-15	Purchased	Mechanical Tools	Screws, drills, nuts and bits	Tools used for building the ROV	\$ 246.71	\$ 2,788.97	
16-01-15	Purchased	Joystick	JoyStickThrustmaster Tflight Hotas X Flight Stick	Used for driving	\$ 200.00	\$ 2,988.97	
19-01-15	Purchased	Connectors	Heat Shrinks	Used for covering wires	\$ 3.00	\$ 2,991.97	
19-01-15	Purchased	Polyethylene	Polyethylene Sheets and end caps	Used for fixing thrusters and isolation	\$ 202.00	\$ 3,193.97	
15-02-15	Rent	Machine Rent	3D Printer and CNC	Used for cutting and printing the arm	\$ 102.25	\$ 3,296.22	
<b>Others</b>							
18-12-14	Purchased	Shipping	Importing components	Convertors shipping and taxes	\$ 10.00	\$ 3,306.22	
19-12-14	Purchased	Shipping	Importing components	H-bridges shipping and taxes	\$ 60.00	\$ 3,366.22	
28-12-14	Purchased	Shipping	Importing components	Tether shipping	\$ 120.00	\$ 3,486.22	
15-02-15	Purchased	Wasted Materials	Components Wasted		\$ 20.00	\$ 3,506.22	
<b>Total ROV Cost</b>						<b>\$ 3,506.22</b>	
<b>Total Fund From AAST</b>						\$ 3,229.22	
<b>Total Donated Items</b>						\$ 277.00	

