

# Viking ROV



## TECHNICAL DOCUMENTATION CAPE HENLOPEN HIGH SCHOOL LEWES, DE, UNITED STATES

**Bill Geppert** - Mentor

**Troy Saltiel** - CEO, Pilot, Report Editor, Poster

**Dylan Elkins** - CFO, Tether Operator

**Raven Blakeney** - Electrical Engineer, Co-Pilot

**Danny Lewis** - Mechanical Engineer

**Lance White** - Safety Officer, Research

# Table of Contents

**About**

3	<b>About Us</b>
4	<b>Company Overview</b>
5	<b>Abstract</b>
6	<b>Budget</b>

**Safety**

7	<b>Safety Overview</b>
8	<b>Job Safety Analysis</b>

**Design**

9	<b>Project Management</b>
10	<b>Frame</b>
11	<b>Mobility</b>
12	<b>Control Box</b>
14	<b>Tether</b>
15	<b>Camera</b>
16	<b>Buoyancy</b>
17	<b>Manipulator</b>
17	<b>Suction</b>

**Diagrams**

18	<b>Final Product</b>
19	<b>Project Costing</b>
20	<b>System Interconnection Diagram (SID)</b>
21	<b>3D Models</b>

**Reflection**

22	<b>Challenges</b>
23	<b>Evaluation</b>
24	<b>References</b>
24	<b>Reflections</b>
25	<b>Acknowledgments</b>

# About Us

The Viking ROV Company is a team of aspiring seniors at Cape Henlopen High School in the Cape Robotics program. We have students that are in the engineering department and students that are in the information technology department. With the combination of the two expertise, we hope to fabricate an astounding team, in both the technical and the engineering elements of the competition. Beyond the competition, many members of the team participate in various organizations, clubs, and sports.

All of us at Viking ROV are second year robotics students, but this organization is brand new to us, as this is the first time we've worked in this team.

Many of us have decided, or have decided which university we are going to, and which major we plan to study. The MATE ROV competition will aid us in gaining real world experience working in a company.

Here is a list of universities and majors for each team member:

Troy Saltiel - University of Delaware (Engineering)

Dylan Elkins - University of Delaware (Financial Planning)

Raven Blakeney - Virginia Tech (Mechanical Engineering)

Danny Lewis - Neumann University (International Business, Marketing)

Lance White - Planning on University of Delaware Engineering

# Company Overview

Each team member has been given a specific job that they are expected to complete. At the initial organization of the company, each member was allowed to choose their job and be evaluated later on. Here are the descriptions for each job in the company.

**CEO** - In charge of the entire operation. This person will oversee the project and make sure everyone is doing their job. If someone has a problem, help them or find another person capable of helping them.

**CFO** - In charge of all planning for the budget, including fundraising and keeping track of what money is spent. This person needs to make sure you take note of what is reused, donated, or bought, as that is a requirement for the budget/expense sheet.

**Electrical Engineer** - This person will be working with the wiring of the ROV. This includes working with the control box and/or wiring to the controller, the tether, and the fuses.

**Mechanical Engineer** - This person will be working on the design and structure of the ROV. This includes creating the frame and mounting motors, a manipulator, and the camera(s).

**Safety Officer** - In charge of creating the safety checklist and providing input to the electrical and mechanical engineers when they are building the ROV. This person must make sure there are no immediate hazards on the ROV. If there is a hazard, for example, the propellers, they should be marked off and a warning should be posted near them.

**Pilot** - This person will be piloting the ROV. He or she must be familiar with the controls and be able to troubleshoot if something goes wrong. (Pilot will be this person's second job)

**Co-Pilot** - This person will be assisting the pilot in operating the ROV. They may be given a certain task to do that one person (the pilot) can't do himself. They will be monitoring the ROV and make sure everything is operating correctly. (Co-Pilot will be this person's second job)

**Tether Operator** - This person will handle the tether of the ROV. You must be able to avoid entanglement of any objects during the operation. (Tether Operator will be this person's second job)

# Abstract

The Viking ROV Company is committed to constructing a high quality Remotely Operated Vehicle (ROV) using our extensive knowledge in science, technology, engineering, and math. Our ROV, Thor, will be fully capable of performing the desired tasks in a timely manner, considering the constraints put forth. With our design, we have engineered effective ways of handling each situation, all in an efficient manner.

ROVs are placed in positions that would be exasperating for humans to voyage. We are tasked to conduct scientific experiments and measurements in an arctic environment that is far from suitable for humans to explore. This includes retrieving algae from the bottom of an ice sheet, measuring the size and location of an iceberg, and alerting nearby oil platforms of dangerous movements of the ice. In St. John's, Newfoundland, the oil industry is a large aspect of their economy. A ROV is ideal to protect the platforms and perform maintenance

on the pipeline. Other tasks include a Close Visual Inspection (CVI) of the pipeline and other routine maintenance such as turning valves, replacing corroded sections of pipeline, and manipulating the wellhead. While it is much safer for a ROV to do such assignments, there are many precautions our team will implement in order to keep operation as safe as possible. We believe that Thor and it's operating team will provide outstanding service to the oil industry with a safe and secure process.



# Budget

## Synopsis

Our program is known for our low cost ROV systems. Holding true to this value, we put ourselves on a impressive \$200 budget while re-using all other parts for our vehicle.

## Re-using Parts

We have an adequate amount of PVC, PVC joints, speaker wire, marine batteries, Johnson Pumps, and black and white cameras from previous school years, which are all available for us to use. To make good use of this, our ROV will be made out of only re-used PVC, the Johnson Pumps we have, and any electronics, such as speaker wire and switches that we can salvage.

## Props, Miscellaneous

The \$200 budget mentioned above is for the ROV system only. The props cost approximately \$300, the competition fee is \$200, and new tools were \$100.

## Travel

While our ROV is very budget friendly, we cannot say the same for travel costs. We are located over 1,800 miles from Newfoundland and must travel by van because of the size and weight of the vehicle.

- Van: \$1,650
- Gasoline / Tolls: \$1,200
- Ferry: \$1,320
- Rooming: \$1,360
- Food / Miscellaneous: \$1,600

**Total: \$7,130**

## Fundraising

To begin the fundraising process, we decided to get as much media attention as possible. We contacted all local media outlets and were featured on WRDE-TV, WMDT-TV, and the Cape Gazette newspaper. We created a GoFundMe page and have raised over \$600 as of May 27th, and will be holding a fund raiser at local restaurant Bethany Blues on June 1st, where we expect to raise upwards of \$4,000. The School District will be funding the remaining amount.



# Safety Overview

Our top priority is to assure the safety of our team and those in proximity of our operations. Our ROV was constructed with care; safety is always in mind. During construction, we required everyone to wear appropriate clothing, such as closed toe shoes, no excess or hanging clothing, among others. Those with long hair are required to tie it up, and there is no hair-spray allowed; for fire safety reasons. When using a tool such as the band-saw or a drill, eye protection is a must.

Our final ROV is as safe as we could possibly fathom. From the wiring, to the tether, to the actual ROV itself, safety was in mind.

The construction of our vehicle is comprised of PVC. This material is rounded, smooth, and innocuous. The most dangerous part of any underwater vehicle are the motors / propellers. Our vehicle features protective motor mounts that surround every motor. We also incorporated zip ties into our design. Zip ties are

very sharp when cut, so we electrically taped all sharp ends, to prevent injury during handling of the ROV.

The tether of the vehicle was also zip tied, and again, we taped any sharp edges. When the ROV is not in use, it is mandatory that the tether be wound up around the spool to prevent tripping. As we get closer to the control box, there is a 25A fuse to prevent damage to any parts of the vehicle.

The control box is our most proud achievement. The tether and control box are separate from each other, allowing for the quick connection and de-connection in case of emergency. It includes a main power switch with LED power indicators, so the ROV can be powered down instantaneously. When the tether operator is handling the ROV, for example, the main power switch will be switched off, to prevent any accidents. We also included safety warning labels on the ROV and box. More information can be found in the design rationale.

# JSA

## JOB SAFETY ANALYSIS (SAFETY CHECKLIST)

Task	Hazard	Recommendation
(1) Transportation	(A) Shorting, Fire (B) Acid Leak (C) Tripping (D) Muscle Sprains	(1A) Please make sure that the power source is disconnected. (1B) Place the lead battery right side up to prevent spillage. (1C) Secure the tether properly. (1D) Have assistance, or assistance ready when carrying the marine battery, or use a cart.
(2) Pre-mission	(A) Electric Shock (B) Slippage (C) Tripping (D) Moving Parts (E) Shorting	(2A) Keep set up area clear of water. (2B) Wear proper footwear, such as high traction shoes. (2C) Secure the tether properly. (2D) Make sure all switches are set to “off” while the ROV is being handled. (2E) A 25A fuse should be included on the tether.
(3) Operation	(A) Electric Shock (B) Tripping (C) Moving Parts	(3A) Continue to keep area clear of water. (3B) Keep tether secure, advise others of it’s presence when walking by. (3C) Turn main power to “off” when team members are handling the ROV.
(4) Cleanup	(A) Electric Shock, Moving Parts (B) Shorting (C) Tripping	(4A) Make sure power is now disconnected . (4B) Keep wet tether away from control box, or dry off tether. (4C) Secure tether around spool.



# Project Management

Our project began with copious amounts of research and planning. Team meetings were held each class in order to keep us organized and to keep each other up to date between different sectors of the company. Decisions such as software control vs. switch control were made in this way. As for job titles, each team member was allowed to initially pick their own job, with the descriptions found in the “Company Overview” section. These jobs were evaluated shortly after to see what worked and what did not.

In order to keep us on track, we kept an activity log which listed what was done that day, who did what, challenges faced, and what we planned on doing next class. We found this to be an effective way to keep our team organized and on schedule. We also kept a parts list, where team members listed what parts they needed for their project, which would then be evaluated as to whether these parts were necessary to purchase or not.

## **Calendar (Made March 1st)**

Mount Motors: 3/19

Mount Valve Turner: 3/24

Mount Claw: 3/24

Suction Device: 3/26

Tether: 4/01

Ballasts Fixed: 4/03

Control Box: 4/04

Testing: 4/04-5/01

Poster: 4/20

Technical Report: 4/27

Regional Competition: 5/02

Re-evaluation, Adjustments, Testing: 5/03-6/15

# Design Rationale

Our team was founded on principles of teamwork and communication. Therefore, we created both a group message and a Google Drive shared folder. The group message ensures that everyone is in touch, and the Google Drive folder allows us to share our ideas and elaborate on them without even being in person. This made it easier for us to collaborate and make decisions in the designing process. Additionally, all of our components are new this year. While the actual pieces themselves are re-used, the *ROV was designed and built from the ground up.*

The first part of the design process was the planning of the ROV system. We initially were going to use software control, but after reflecting over previous years implementations, we decided that we did not have the time required and switches are a proven method.

## • FRAME •

The basis of our ROV is constructed of PVC, and we decided to use a rectan-

gular design for Thor. It is a conventional design, but we believe that it is a simple, exceptional form factor for an ROV. Many successful ROVs have used this quintessential shape. Upon further research, we've found that this design is not only straightforward, but it is more hydrodynamic than a box shaped design. This is due to its lesser height dimension when comparing to a box design. Additionally, we are able to fit all essential devices on board the ROV, which will keep it compact. We found PVC to be the best material to construct the frame due to its low cost and strength. Additionally, changes can be made to the structure with little consequence.

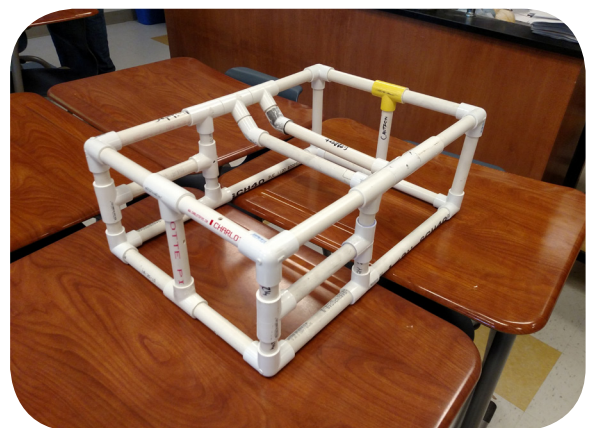

Our original design, before any additions.

# Design Rationale

## • MOBILITY •

Our motors consist of 500 & 750 Gallons Per Hour (GPH) Johnson Pumps, fitted with two blade props. The props we have chosen work the best to provide thrust. This is due to their larger pitch and helix angle, which results in a larger thrust, but decreases the performance against resistance. This will be beneficial to us during the first two demonstrations, as there is no resistance. During demonstration #3, the flume tank will have a constant current of 0.25 meters per second. If need be, the propellers can be quickly interchanged by replacing the chucks before this demonstration.

The propellers are protected by a shroud, that also acts as a mounting system for the motors. The mount was designed and 3D-printed by our team. A 3D model can be found in the “Diagrams” section on page 16. The shroud was implemented for both safety and design reasons. With a tight housing around the propeller, less propulsion is lost by the tip of the blade, and all thrust is directed in one direction. This will make for a faster, more energy ef-

ficient vehicle. Another advantage to our motor shroud is its mounting system onto the ROV. There are three mounting points that are meant to fit around 1/2” PVC. This system makes for a safe, stable motor to ensure any jitter in the operation of the craft will not alter the positioning of the motor.

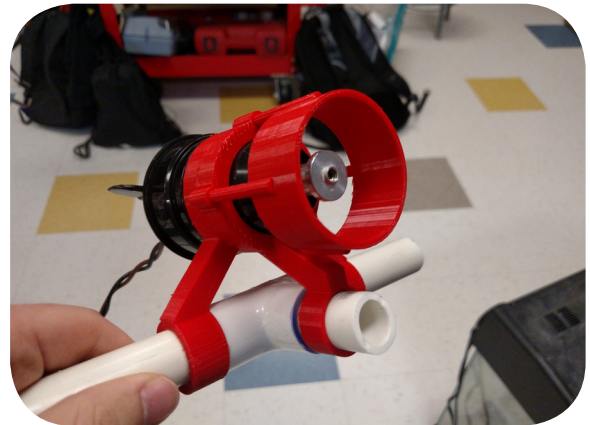

Our motor mount design.

Thor has a forward/backward motor on the left and right side, and two up/down motors on the top. With two motors on the top, one can be deactivated to create a pitch. This will make it easier to manipulate objects. The up/down motors use a 750 GPH motor, while the forward/backward motors use a 500 GPH motor. This is because it requires more thrust to ascend.

# Design Rationale

## • CONTROL BOX •

The control box was designed from the ground up, for ergonomics and maneuverability. It is constructed of wood and measures 38cm x 29cm x 20cm (LxWxH). To make it more portable, we decided to keep it separate from the tether, that way we connect it when needed, and there's no chance of the innards being loosened.

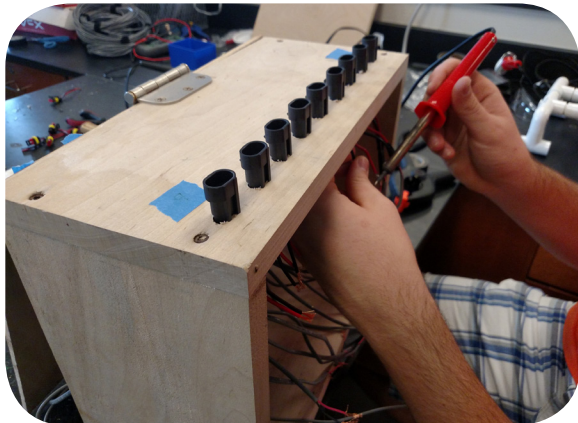

The tether connects to the control box.

The control scheme is similar to that of a game controller. The four switches that control the steering of the ROV are positioned in a diamond. The left and right control the left and right motors, respectively. The further and closer switches control the further and closer up/down motor, respectively. A simple

layout will allow the pilot to maneuver the sea to their best ability. There are three more switches on the right side that control the manipulator and suction. Above that are two camera switches, that will allow us to save power when we are not using a camera. To the back left, is the main power switch.

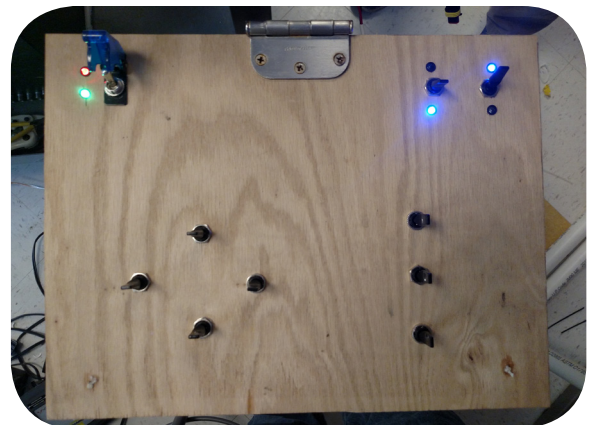

The final control box without monitors.

The box can be opened from the top in case there is any malfunction. It is mounted on a hinge, and to avoid any tugging, we included a string that will cease the box from being opened beyond the length of the wires inside.

Since our box needs to be connected to the tether to be powered, we decided to add LEDs to the box to indicate



# Design Rationale

power. This makes it easier for the pilot and is an appreciable safety feature. When the power is connected to the box, an LED next to the main power switch will light RED. When the main power switch is in the “ON” position, an adjacent LED will light GREEN.

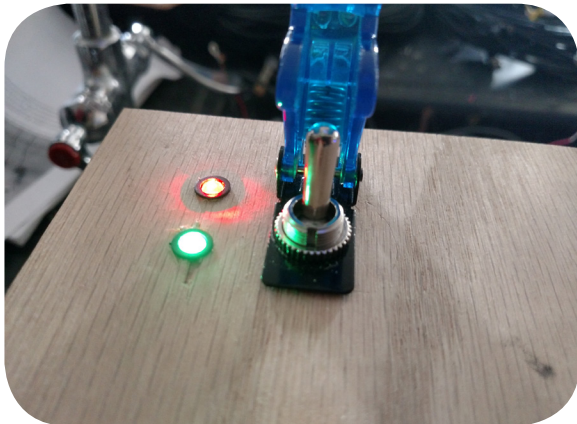

Main power connected, ROV / box on.

Additionally, we included a spring loaded cover for the main power switch, so that it could be powered off quickly in case of emergency. If it is accidentally powered off, the green light will turn off, and power can be restored immediately upon setting the switch back to the “ON” position. The LEDs are meant for 12v, and have built in resistors. Furthermore, we added LEDs adja-

cent to the cameras to indicate which camera is powered on. Since we will have four cameras, this will allow us to save energy with our limited 12v supply by running only two at once.

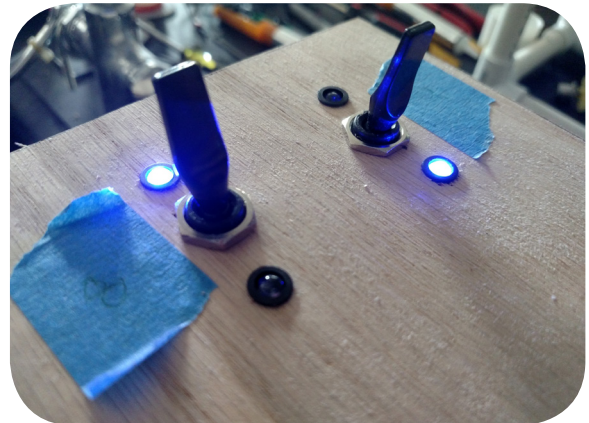

Camera switch. Left is ON, right is OFF.

Finally, the control box also houses two 7” TFT Color Monitors, which are mounted to the top center of the box. This ergonomic design allows the pilot to have the display right in front of them and there is no additional set up required. These displays run off of 12v and hook up to the marine battery. They have two video cables, allowing them to run two cameras at once, switching at the touch of a button. Furthermore, this all-in-one box adds to the portability of the system.

# Design Rationale

## • TETHER •

Our tether is composed of 16 gauge speaker wire and camera wires. There are seven speaker wires and two camera wires, at 15 meters a piece. We've found that with 16 gauge wire, there is not a significant resistance to lower our power draw from the marine battery to the ROV. While a lower gauge wire would be better in theory, it is not cost effective, nor is it as pliable. Therefore, the 16 gauge wire is appropriate for our needs.

As previously mentioned, our tether is separate from our control box. To make it easier to designate where each wire connects to the box, we color coded each wire to the box.

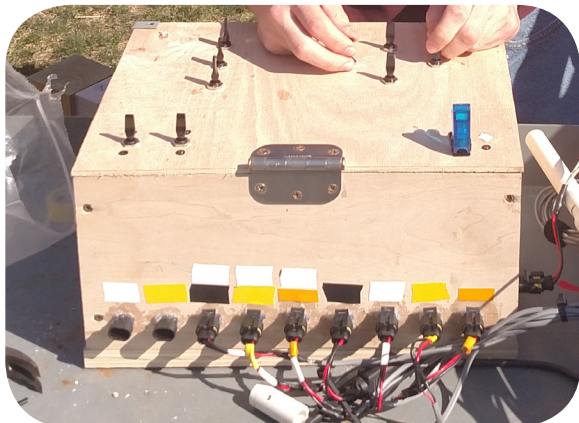

Color coding from the tether to the box.

We chose 15 meters for our length since the depth of the pool at regionals is 5 meters, and missions can be up to 10 meters away from the pool. Using the Pythagorean theorem, the maximum distance our tether would need to extend is approximately 11.18 meters. We added a few meters to that in order to have some extra travel room. For internationals, the maximum pool depth is 4m, and this is an adequate length of tether. To keep our tether organized for travel, we have created our own spooling system out of PVC. It only needs one person to operate, and makes for easy spooling and storing. It consists of two "U" shaped sides, connected by a single piece of PVC in the center.



Our tether spooling system.



# Design Rationale

## • CAMERAS •

Originally, our camera consisted of one waterproof, color bullet camera, and one black & white bullet camera. After testing the colored camera, we found out that the camera was no longer functional, likely due to an acid leak during travel with last year's team. Luckily, our black & white camera is functional, but we had to brainstorm a new, more cost effective way to replace our waterproof color camera. The color camera will allow us to identify the species of sea stars.

After some evaluation, we found that the best replacement would need some extra work to complete. We decided to buy an inexpensive water-resistant back-up camera. Unfortunately, the camera has an Ingress Protection rating of 65 (IP65), meaning it is dust tight, but only protected against water jets and not against submersion underwater. To remedy this, we went through a process called "potting".

The first step in the process required

us to glue the camera aperture directly to a piece of Plexiglas. Though, the lens of the camera is rounded, which made it difficult to glue it directly to the glass. To resolve this, we CA glued a nut that was similar in size of the aperture of the camera. This provided more space between the housing of the camera and the Plexiglas, allowing us to now glue the camera with the nut directly to the glass. Next, we coated the camera itself in RTV to create an initial waterproof seal. This would now allow for us to house the camera. We used a 3/4" PVC "T" to house it. The camera, with the glass, was then glued to the PVC and filled with RTV to create another seal.

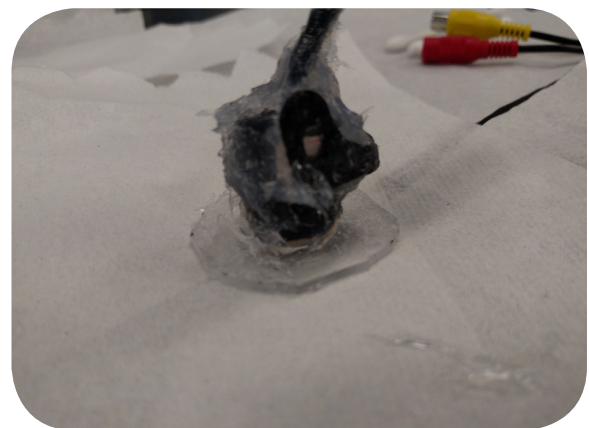

The camera, glued to the nut and glass, RTV'ed.

# Design Rationale

To mount the camera to the ROV, we decided to continue using PVC, for its simplicity and convenience. We extended the camera wire straight out the back of the “T”, which was connected to a 3/4” section of PVC. This required us to drill an outlet hole for the wires. Since our ROV is built with 1/2” PVC, we decided to use a 3/4” to 1/2” converter “T”, this way we can angle the camera any way we need to.



The final camera assembly.

## • BUOYANCY •

Our buoyancy consists of two 2” PVC pipes sealed with end-caps. The caps are sealed with waterproof RTV. We positioned the ballasts on the outermost section of the ROV, in order to

keep it as balanced as possible. Unfortunately, the ROV is not perfectly symmetrical, so we had to perform some minor adjustments in order to get the buoyancy just right. To remedy the situation, we attached what was the bottom of a milk crate, to the bottom of our ROV. This would allow us to add fishing weights, or sinkers, of various weights (1-5 ounce) to our ROV. The sinkers slot into the holes of the crate, making minor adjustments effortless. With some trial and error, we required just a few sinkers throughout the bottom of the ROV to get it balance. Additionally, we were able to achieve neutral buoyancy.

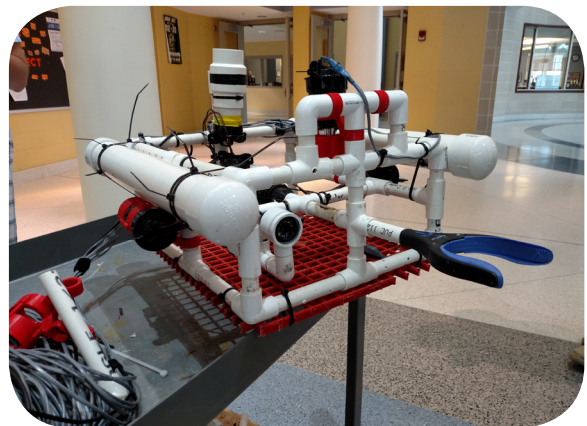

The ROV, with ballasts and milk crate bottom.

# Design Rationale

## • MANIPULATOR •

The ROV consists of two different manipulators. We have a mechanical arm, which is constructed of a grabber, controlled by a motor. The motor spins a bolt, with a wing-nut attached to it, which effectively pulls a wire, opening and closing the arm via the tensivity of the wire. This manipulator will be our primary device, as many tasks require us to grab onto objects, such as carrying or picking up various objects. Our second manipulator will be a hook, which is attached to the front of the ROV. The hook will require less precision, and will be less challenging to “hook” to something. For example, some tasks require the removal of U-Bolts.

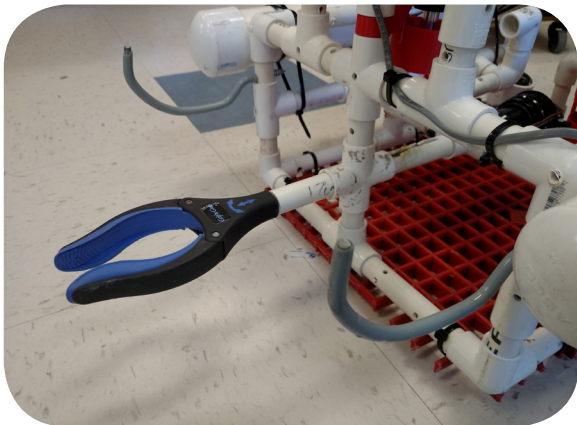

The claw and the two hooks.

## • SUCTION •

One specific challenge during the mission is to extract a sample of algae, which is represented as a table tennis ball. This ball is to be floating just below the surface, on the bottom of the ice sheet. A manipulator is not ideal to recover the ball, as it is difficult to pick up, and it may damage the algae/ball. To remedy this, we decided to use a suction device. Our design is using a 1000 GPH motor attached to a 1-1/2” to 2” coupling with intake holes cut in them, which is then attached to a 2” to 1-1/2”. The motor effectively creates a whirlpool type effect, which pulls the ball into the device. The ball fits perfectly into the opening, and suctions into the coupling.

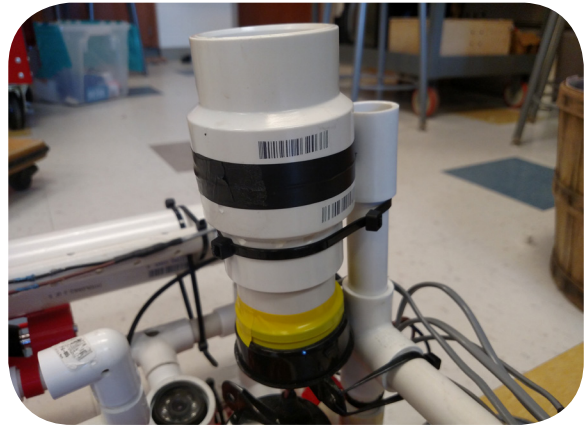

Our suction device, attached to the ROV.



# Final Product

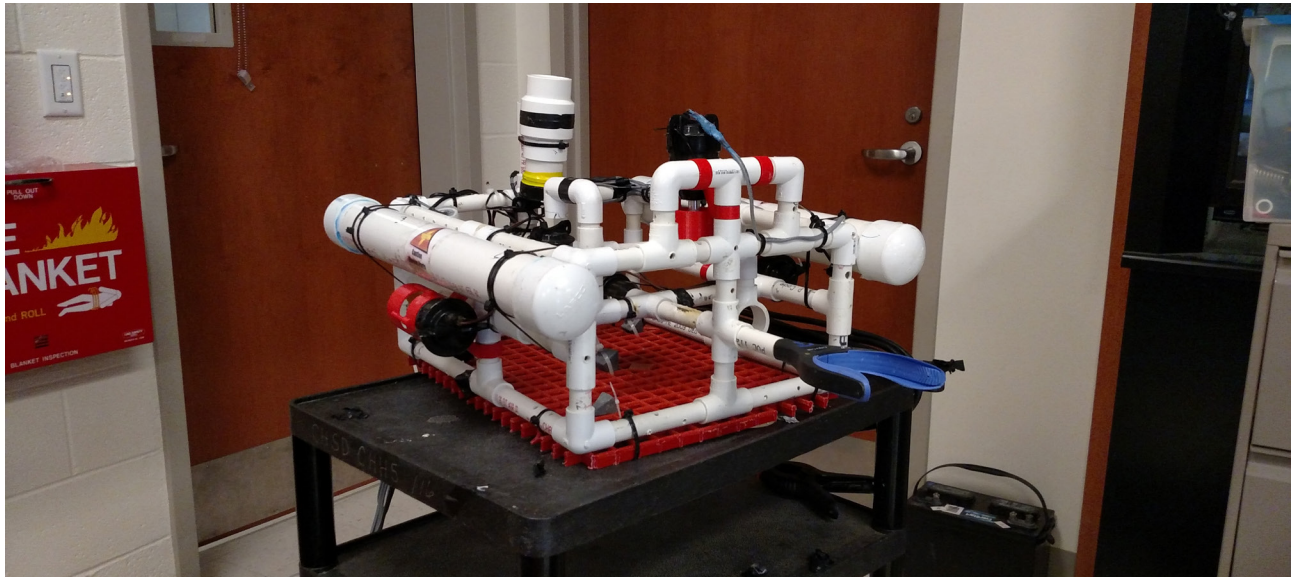

The Final ROV - Front View

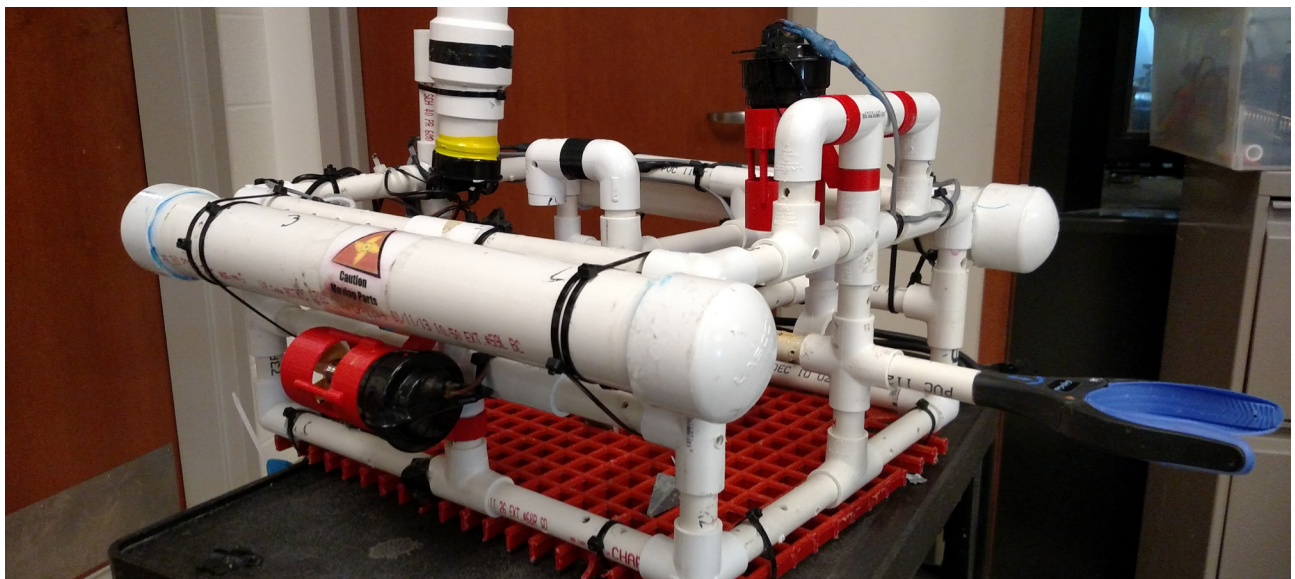

The Final ROV - Close, Side View

# Project Costing

Item	Quantity	Re-used (\$)	Purchased (\$)	<i>Totals</i>
1000 GPH Motor	1	35.73		<b>Overall System:</b> \$896.54
750 GPH Motor	2	61.74		
500 GPH Motor	3	62.28		
Color Camera	2		39.98	
B & W Camera	2	200.90		
Marine Battery	1	91.97		
Motor Mounts	4		2.24	
Hooks	2	3.54		<b>Amount Reused:</b> \$666.12
Speaker Wire	105m	50.00	17.20	
3-Way Side-out	8	11.52		
Crosses	7	16.03		<b>Amount Spent:</b> \$160.70
"T"s	20	9.60		
Elbows	6	2.76		
1/2" Coupling	1	0.81		
1" Eyelet	1	1.79		
1-1/2 to 2" Coupling	2	2.58		<b>Amount Donated:</b> \$68.00 (Poster, Report)
1/2" PVC	3m	2.12		
7" Monitor	2		45.98	<b>Services Donated:</b> None
Zip Ties	100		4.27	
RTV	1	3.67		
Switches	10	56.70		
Wood	1		30.00	
LEDs	6		1.08	
Bus	2	17.12		
Arm	1	16.72		
Propellers	5	15.00		
Tether Connectors	10		9.95	

# SID

## SYSTEM INTERCONNECTION DIAGRAM

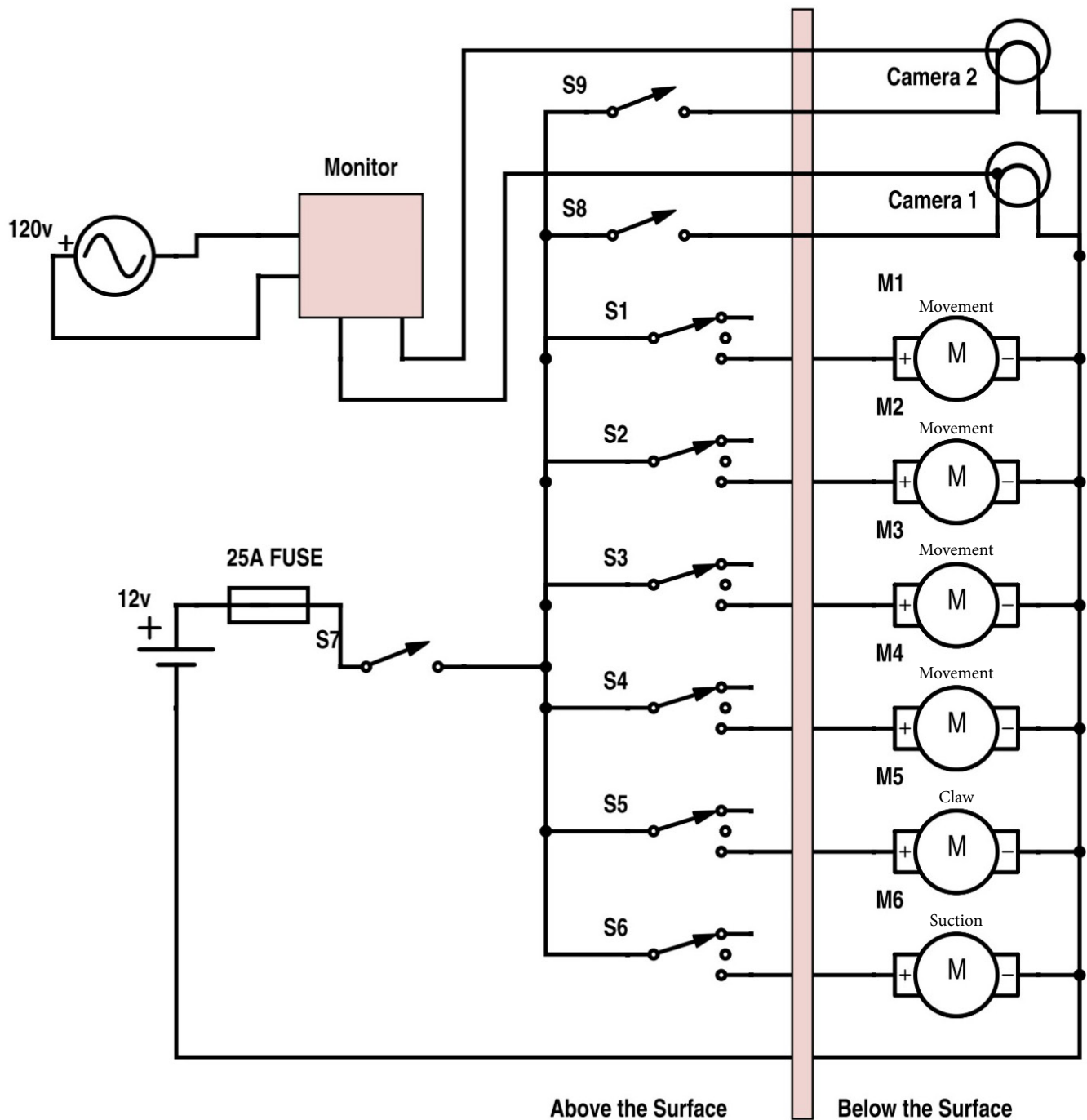



# 3D Model

## Motor Mounts (Subsystem Diagram)

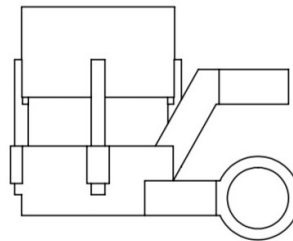
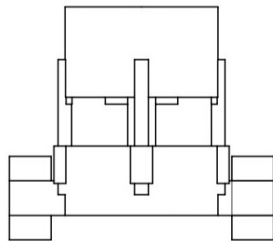
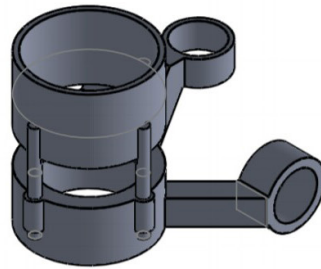
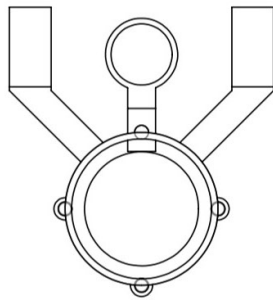

PROPRIETARY AND CONFIDENTIAL  
THE INFORMATION CONTAINED IN THIS  
DRAWING IS THE SOLE PROPERTY OF  
<INSERT COMPANY NAME HERE>. ANY  
REPRODUCTION IN PART OR AS A WHOLE  
WITHOUT THE WRITTEN PERMISSION OF  
<INSERT COMPANY NAME HERE> IS  
PROHIBITED.

		UNLESS OTHERWISE SPECIFIED:	NAME	DATE	
		DIMENSIONS ARE IN INCHES	DRAWN		TITLE:
		TOLERANCES:	CHECKED		
		FRACTIONAL $\pm$	ENG APPR.		
		ANGULAR: MACH $\pm$ BEND $\pm$	MFG APPR.		
		TWO PLACE DECIMAL $\pm$	Q.A.		SIZE DWG. NO. REV
		THREE PLACE DECIMAL $\pm$	COMMENTS:		<b>A</b> Motor Mount
		INTERPRET GEOMETRIC TOLERANCING PER:			SCALE: 1:2 WEIGHT: SHEET 1 OF 1
		MATERIAL			
		FINISH			
	NEXT ASSY	USED ON			
	APPLICATION				
			DO NOT SCALE DRAWING		

5

4

3

2

1

# Challenges

## Technical Challenges:

Our original system design implemented a computer chip and software control. Because computer chips are too complicated for the design we need, we decided to transition to switches. We've had problems in the past with computers, and switches are always reliable as long as they are wired correctly.

The next implication was our valve turner. While it worked well on paper and on land, it did not work well after adding water resistance. We had changed out the motor from 500GPH to 1250GPH to no avail. Ultimately, we decided against using it. Instead, we are going to use the ROV itself, along with the hooks, to turn the valve.

The control box initially had a few problems. Firstly, the original main power switch could not support the amperage we were sending through it, so we had to purchase a new switch. Next, the box needed some kind of latch, and something to stop us

from over opening the box, which could pull wires. We decided on using a string to stop the over opening, and two "L" latches to slide over the box to stop it from opening.

Motors were not always operating correctly. We've faced problems from grinding with mounts, to the propellers falling off. To troubleshoot this, we had to make some adjustments in the positioning, along with replacing any short or rusty screws.

In the beginning, we had a high quality color camera. Unfortunately, during the travel from internationals last year, there was a battery leak, which destroyed many of the cameras that the Explorer team had used the previous year. Our troubleshooting led us to the final decision to pot an inexpensive camera instead.

Of course, there were some interpersonal challenges, which can be found in our evaluation on the next page.

# Evaluation

Our company did a tremendous job with the short period of time allotted for the construction of our ROV. We were efficient at recording our progress and creating technical documents. Our ROV is very safe, and it is simple, well constructed, with small dimensions, while everything is accessible and interchangeable.

## **Non-Technical Challenge:**

The control box for the ROV was the best part of the system as a whole, though we could use improvement in the engineering of the ROV itself. We feel that we could have fabricated more parts that would have accomplished more during the mission, or would have made the system more efficient. Additionally, work ethics for the group as a whole could be worked on. Tasks need to more evenly shared, and work needs to be more productive.

## **Lessons Learned:**

What is most important though, is what we have taken from the experience. The most beneficial part of this

project was interacting with others to complete one final product and gaining the experience. No matter the major those of our team go into, they can use the skills they learned here and apply it to their studies. Working with a team, spending your time wisely, and communication skills are all appreciable skills to possess, and the MATE competition definitely helped us improved them.

## **Future Improvements:**

Next time, we need more time to troubleshoot the issues with our ROV. The first draft of the vehicle needs to be completed at least two months before the competition, because you never know what problem will come up. Time needs to be spent more wisely, and group organization needs to improve. In the end, it was a fun, valuable experience, and we are happy we were a part of it.

# References

## General Mission Information

<http://www.marinetech.org>

## Mobility

<http://en.wikipedia.org/wiki/Propeller>

[http://en.wikipedia.org/wiki/Ducted\\_propeller](http://en.wikipedia.org/wiki/Ducted_propeller)

## Flume Tank, Ice Tank, Offshore Engineering Basin Specs

<http://www.oceaniccorp.com/shipping/physical.html>

<http://www.mi.mun.ca/facilities/flumetank/>

[http://www.nrc-cnrc.gc.ca/eng/solutions/facilities/marine\\_performance/engineering\\_basin.html](http://www.nrc-cnrc.gc.ca/eng/solutions/facilities/marine_performance/engineering_basin.html)

# Reflections

**Troy Saltiel:** As the CEO, I learned just how tough it is leading a group of people, on top of communicating with media and the work associated with it.

**Raven Blakeney:** As the Electrical Engineer, I gained knowledge and experience with wiring. You're better safe than sorry; secure everything!

**Dylan Elkins:** As the CFO, I saw first hand how to work with a tight budget. I had to do research in order to cut the costs where I could.

**Lance White:** As the Safety Officer, I had to stay on top of my team. It is difficult managing so many people with all of the precautions we had in place.

**Danny Lewis:** As the Mechanical Engineer, I learned that planning is the most important phase of construction. It'll save you time too!

# Acknowledgments

## Thank You To:

Mr. Bill Geppert - For being an outstanding mentor

The volunteers who make this competition possible

Those who donated to our GoFundMe @ [gofund.me/chsrobotics](http://gofund.me/chsrobotics)



Regional Sponsors



For devising the competition



**MARINE INSTITUTE**

For providing their facilities  
(International)



For providing their facilities (Regional)



Local Sponsor



For helping fund the trip

The extensive list of sponsors for the International ROV competition

@

<http://www.marine-tech.org/sponsors/>