



# Oceanus II

A Titan Amongst Gods

From Sea-Tech 4-H

Located in Mt. Vernon, WA, USA



Spencer Cocheba, CEO  
Isaiah Houghton, CFO  
Andre Tinnon, R&D  
Satone Haratani, EHS  
Alora Houghton, MD  
Priya Kumar, DOD

Mentor: Dr. Jay Cocheba



## **Introduction**

Oceanus II is one of 4 teams which are part of Sea-Tech 4-H located in Mount Vernon, WA. Sea-Tech was originally conceived of as a homeschool engineering club in 2000 by Lee McNeil, an engineer at Boeing. In 2001 Sea-Tech became a 4-H club. In 2007, the club discovered Marine Advanced Technology Education (MATE). They began building and competing with their ROV's in MATE sponsored events that year. In the 15 years since Sea-Tech began, the club has fabricated a total of 45 ROVs and competed with 31 of them. This is ROV Oceanus's second year in competition. Our team structure is comprised of three veterans, and three new recruits, forming a precise balance of experience and fresh minds with aptitude for exploring new techniques and ideas, all with a passion for engineering and creativity.

ROV Oceanus was designed to be simple, robust, versatile, and effective for any marine scenarios we might encounter. It is remarkably versatile, providing an efficient platform for implementation of various tools and sensors allowing it to perform an assortment of tasks. The goal of team Oceanus II is to optimize our already proven design while preserving its ability to be re-configured for future missions both in competition and in the real world. Versatility, durability, and adaptability remain our chief goals as we continue our work with Oceanus II.

## **Abstract**

Construction of ROV Oceanus began in 2013. This year we improved upon our vehicle to perform various mission tasks specific to this year's theme. We have configured Oceanus to fit through the 75cm x 75cm hole in the ice. The maneuverable forward camera/manipulator mount rotates from horizontal to vertical, allowing us to visualize and manipulate hard-to-reach objects effectively. One of two high definition (HD) cameras is mounted on the rotating platform providing clear views of the grasper in both positions. The second camera is mounted aft for monitoring our tether and as a second vantage point for observational tasks. We designed our unique float from polyurethane foam and laminated it with carbon fiber and epoxy resin for durability. Our ballast is mounted centrally and low on the ROV for greatest righting moment. It is constructed of removable steel plates allowing for adjustment for freshwater and saltwater. We fabricated shrouds for our Next Generation Sea-Tech thrusters and installed four L.E.D.s for illumination.

Overcoming various challenges through hours of hard work, we gained valuable knowledge and skills. We learned to use CAD software, generate wiring diagrams, persevere through teamwork, communicate effectively, maintain documentation, and fabricate through various techniques. We did our own powder coating, epoxy and carbon fiber lamination, wiring, lathe work, seal testing, etc. We also learned about real environmental issues involving the Arctic. In the future, we will manage our project so that there is more time for practice prior to competition.

# Table of Contents

1	Introduction.....	Pg.2
2	Abstract.....	Pg.2
3	Team Biographies.....	Pg.4
4	Inspiration.....	Pg.7
5	Schedule.....	Pg.8
6	Communication.....	Pg.9
7	Teamwork.....	Pg.9
8	Real World Applications.....	Pg.10
9	Our Own Real World Experience.....	Pg.10
10	Mission Theme.....	Pg.11
11	Mission Tasks.....	Pg.12
11.1	Task One: "Science Under The Ice".....	Pg.12
11.2	Task Two: "Subsea Pipeline Inspection & Repair".....	Pg.12
11.3	Task Three: "Offshore Oilfield Production & Maintenance".....	Pg.12
12	ROV Design and Fabrication.....	Pg.12
12.1	Frame.....	Pg.12
12.2	Buoyancy.....	Pg.13
12.3	Ballast.....	Pg.13
12.4	Thrusters.....	Pg.14
12.5	Cameras.....	Pg.14
12.6	Pneumatics Systems.....	Pg.14
12.6.1	Pneumatics Diagram.....	Pg.15
12.7	Electrical Systems.....	Pg.16
12.7.1	Wiring Diagram.....	Pg.17
12.8	Mission Tools.....	Pg.18
13	ROV Evolution.....	Pg.18
14	Assembly.....	Pg.19
15	Safety Measures.....	Pg.20
16	Testing and Troubleshooting.....	Pg.21
17	Cost.....	Pg.22
18	Lessons Learned.....	Pg.22
19	Group Reflection.....	Pg.23
20	Individual Reflections.....	Pg.23
21	Acknowledgements.....	Pg.25
22	References.....	Pg.25

# Team Biographies



Taken by: Kaylie Houghton

## **Spencer Cocheba**

Frame, Buoyancy and Ballast Specialist

Company Role: CEO

Competition Role: Pilot

Years in MATE: Five

Years in Sea Tech: Four

Age: 16

In addition to MATE, Spencer has also competed in several FIRST Robotics competitions. He is a very capable pilot and captain of team Oceanus II. He is also competent in every area of ROV operation and maintenance. He has had an interest in robotics and engineering for many years, having a technical mind and a drive to learn new things. He is a devoted, capable, essential, and truly valuable resource to the team.



Taken by: Kaylie Houghton

## **Isaiah Houghton**

Pneumatics Specialist

Company Role: CFO

Competition Role: Manipulator Operator

Years in MATE: Two

Years in Sea Tech: One

Age: 16

Having had an interest in design and engineering from a young age, Isaiah enjoys figuring out how to solve various tasks in creative ways. He originally joined the FIRST Robotics program before he entered the Sea-Tech club. He has worked to learn as much as he can from this year. He plans to apply knowledge and skills gained through this experience, seeking a career in an engineering field. In addition to robotics, Isaiah is a homeschooling student who enjoys carpentry, drawing, piano, and participating in a speech and debate club. He is a devoted member, talented writer, and valuable asset to our team.



## **Andre Tinnon**

Thruster Specialist

Company Role: Research and Development

Competition Role: Lieutenant

Years in MATE: Three

Years in Sea Tech: Two

Age: 15

Taken by: Kaylie Houghton

Andre is a high school sophomore now living in Spokane, WA. He is fascinated with marine technology and biology. He was a founding member of team Oceanus and contributed to the new developments of team Oceanus II's ROV. His favorite aspect of this year was seeing how far his team could go by remaining focused upon the tasks and goals at hand. He saw them through to successful realization of their goals. Currently, Andre is looking into options for university studies. He is particularly intrigued by the fields of engineering and biology. In his free time, he loves to play the acoustic guitar, binge on music, and explore physics with his skateboard.



## **Satone Haratani**

Mission Tools Specialist

Company Role: Environment Health and Safety

Competition Role: Data Analyzer

Years in Sea Tech: One

Years in MATE: One

Age: 14

Taken by: Kaylie Houghton

Satone was introduced to Sea-Tech 4-H by Priya Kumar, her 6th grade class mate and a Sea-Tech veteran. She loves seeing how things work and making things better for a good cause. She attends Anacortes Middle School as an 8th grader. She started Sea-Tech with very little knowledge of ROVs but a keen desire to learn about something new. She learned much from the experience of working with her team mates and mentor. Besides her interest in ROVs, she enjoys playing various instruments, drawing, and running. Her goal is to attend university where she would like to study engineering.

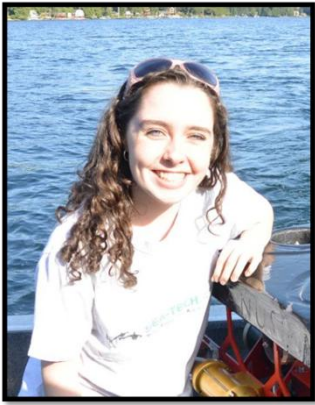

## **Alora Houghton**

Controls Specialist

Company Role: Marketing Director

Competition Role: Tether Tender

Years in Sea Tech: One

Years in MATE: One

Age: 16

Taken by: Kaylie Houghton

Alora is a homeschooled student that has possessed an interest in how mechanical systems work from a young age. This year, she has especially enjoyed pursuing that passion in the construction, testing, troubleshooting, and use of her team's ROV. The culmination of her experience was competing with her team at this year's Pacific Northwest Regional MATE competition where they took second place in Ranger Class. Prior to her involvement with MATE, she has been active in FIRST Robotics with her local high school. She looks forward to sharing her diverse interests through teaching others about robotics and engineering. In addition to her involvement in robotics and engineering, Alora is an accomplished pianist and participates in a speech and debate club.



## **Priya Kumar**

Camera Specialist

Company Role: Director of Documentation

Competition Role: Mission Commander

Years in MATE: Three

Years in Sea Tech: Three

Age: 14

Taken by: Kaylie Houghton

Priya is a hardworking homeschooled student who enjoys learning and taking on new challenges with gusto. She joined Sea-Tech without very much prior exposure to engineering. She sought experience, formidable challenges, and an opportunity to try something new. This year, Priya was in charge of refining and facilitating documentation as well as much of our marketing and fundraising efforts. Her dedication and devotion went beyond the call of duty. She earned profound appreciation from the team. Priya is a very valuable asset to the team not only for her writing abilities, but also for her leadership skills. She is currently interested in entering a field that involves some combination of technology, design, engineering, medicine, or business. One of her other pursued interests is artistic roller skating.



Taken by: Thomas Janicki

### Dr. Jay Cocheba (Our Mentor):

Dr. Cocheba is a podiatric physician and surgeon. He specializes in biomechanics, pediatric limb deformities, and limb salvage. He has published journal articles and research in those fields. Part of his research involves use of robotics and sensory systems to reanimate a cadaver leg, making it walk for study of biomechanics and surgical procedures. Along with his many other engineering interests, his research experience provides a foundation of knowledge with which he can mentor our team. He also instructs medical students both in clinic and lecture settings, so it seemed a natural transition to become a mentor in our Sea-Tech club.

## Inspiration

The name Oceanus was borrowed from Greek mythology. Oceanus, meaning “River Ocean,” is one of the 12 titan children of the Greek gods Gaea and Uranus. He is the titan of large bodies of water. This fits well with the vast Arctic Ocean upon which this year’s MATE theme is based. After we chose our name and began researching images, we realized that Oceanus was often represented with crab pincers on his head. This, along with what we learned about human influence on biology of the oceans provided the inspiration for our team logo. We based the

design on a unique species of crab, native to the coastal waters of Japan. Its carapace resembles a human face. This amazing phenomenon is due to an ancient myth that crabs possessing these strikingly accurate shapes of human faces were indeed the reincarnation of ancestors who were buried at sea. Japanese fishermen who caught them in their nets, quickly threw them back accompanied with solemn apologies for having disturbed them. In doing so, they unintentionally selected for crabs with this shape of carapace over generations. That most fortunate species of crab, is what we now call Heikegani.



Oceanus



Heikegani



Oceanus

# Schedule

At the beginning of the year, we identified and prioritized what needed to be done with the ROV to resolve issues encountered last year and to add capabilities specific to this year's mission tasks. We compiled our list and estimated the time each project would take to complete. A summarized version is displayed below.

## To Do List:

### - Thrusters:

Check resistance (15 minutes)

Disassemble, inspect, and clean motors (6 hours)

Check and repair leaking housings (5 hours)

Define clearance on the propellers shrouds and fabricate/install shrouds (2 hours)

### - Cameras:

Changing mounts:

Research (1 hour)

Building (9 hours)

Research topics: 1) coefficient of thermal expansion 2) what material has the least expansion 3) what to fill the gap behind the camera with (idea: mineral oil)

### - Tether:

Deconstruction (1 hour)

Resistance testing of conductors (30 minutes)

Reconstruction and installation (30 minutes)

### - Lights:

Check and fix leaks that caused failures last year (30 minutes)

## Mission Tools To Do List:

- Task 1, #2: Algae collecting tool (2 hours) idea: PVC pipe tool

- Task 1, #6: Measuring the iceberg (4 hours) ideas: tape measure with weight and float and/or four lasers

- Task 3, #4: Measuring the angle of the wellhead (15mins)

- Task 3, #3: Measuring the wellhead (2 hours)

- Task 3, #7: Acquire and test pump to push water through the pipeline (2 hours)

- Task 2, #7 : Make lift line (1 hour)

Poster: 36 hours

Presentations: 5 hours

Estimated Total: 78 hours estimated (which ended up being a gross underestimation)



### **Project Milestones:**

- reconstruct and test tether January 16th
- clean the thruster motors January 23rd
- have the cameras fixed January 30th
- finish kort nozzle work February 13<sup>th</sup>
- check and fix lights February 20th
- have the mission tools completed February 27th
- be able to put the ROV in the water by April 3<sup>rd</sup>
- have presentations completed march 6th

## **Communication**

Communication is essential when working as a team. We primarily used email as our predominant means of communication and collaboration outside of meetings. We shared information, notes, planning, and ideas. Effective communication helped us work well together and grow as a team. We also discovered Google Drive as a means of collaborating on documentation. We found it beneficial to have the group on the same page, especially when a team member was unable to attend a meeting. Often, we found that communication was more effective when collaborating through email than calling. Use of email assured that everyone could receive the same information at the same time and be able to review information with less confusion than might have occurred with call chains. Email and use of Google Drive also provided a sort of paper trail for reference in documentation efforts as well as reviewing goals and assessing progress. Secondary forms of communication were calling and texting. These were effective when an immediate response was needed. Having a strong foundation to our communication helped our team work together and get work completed effectively.

## **Teamwork**

Oceanus II has worked fervently to provide each member of the team an equal share in the work effort. Each contributing a specific skill to the design and fabrication process as a whole. Though we have all worked on the ROV in general, each of us took on responsibility for a specific aspect, specializing and becoming knowledgeable in that particular attribute of the ROV. We have also kept a log of hours worked. Our Director of Documentation sent a week-to-week schedule to keep everyone on task. We decided to change these aspects of our ROV based upon our deadlines and the overall simplicity of our design. We made decisions as a team, capitalizing on the benefit of each member's aptitudes. This was incredibly useful, as there was the entire team working as one to coordinate with ideas, schedules, and fundraising opportunities. We made our final decisions by coming up with a list of ideas and eliminating options until we came to the most reasonable choice. We worked as a unanimous vote, or not at all. This experience has helped us bond together as a team.

## Real World Applications

Remotely Operated Vehicles first began as an efficient and cost-effective way for the Navy to retrieve submersed property from the sea floor. After Frenchman Dimitri Rebikoff first developed his “Poodle”, one of the earliest ROVs, in 1953, the potential of exploring the ocean depths for long periods of time was realized. In 1966 the United States Navy built the Cable-controlled Undersea Recovery Vehicle (CURV) for the purpose of finding a hydrogen bomb near Spain under 2800 feet of water. Soon oil companies became interested in using unmanned vehicles to maintain offshore assets. The commercial use of ROVs grew more and more popular.

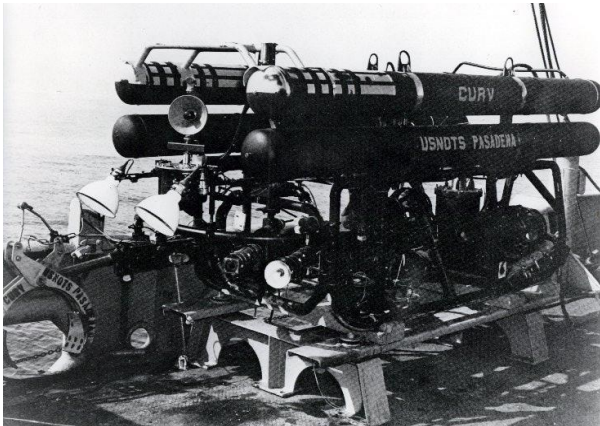

An ROV Above Water

Today ROVs are used all around the world for innumerable missions including underwater exploration, undersea maintenance, and military missions. In 1985 the ROV *Angus* was sent to the bottom of the ocean floor to survey the remnants of the newly discovered shipwreck RMS Titanic. A year later *Argo*, *Alvin*, and *Jason Jr.* made their way to the sunken ocean liner. Currently a class of

ROV called *Nereus* is capable of descending to the Marianas Trench and collecting biological samples from the frigid environment. In the year 2022, NASA plans on launching a mission to the icy surface of Europa, a moon of Jupiter, to investigate a potentially sub-ice ocean with a submersible attached to a spacecraft. The advancements of underwater exploration is growing evermore endless, and with new technological discoveries, science under the ocean is possible like never before.

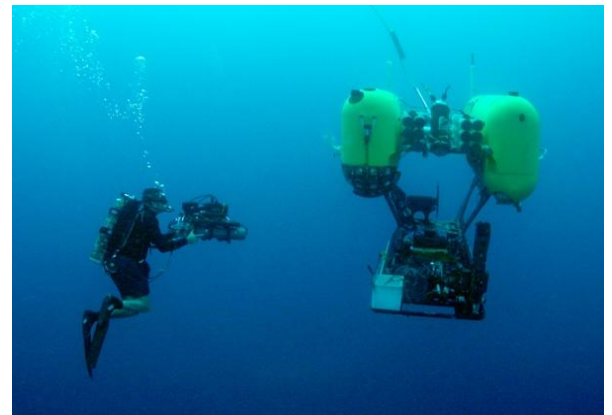

An ROV Below Water

## Our Own Real World Experience

One of the best experiences our team had this year as Oceanus II was traveling to Lake Cavanaugh to test our ROV. We transported the ROV about 45min to a boat launch on the lake. After setting up our equipment and launching the platform craft, we went in search of an area shallow enough to explore with the ROV, as the lake was over 30m deep (100ft) in some areas but deep enough to test seals. To locate the desired depth, we used a sonar scanning

device mounted on the boat. Although it started out slow, the excitement quickly accelerated as we dove down to approximately 9m (30ft). Our ROV scoured through the lake bed, searching for various items to take to the surface. Our monitor enabled us to speedily identify several discarded cans and catch glimpses of startled fish. We caught sight of a bundle of rope and even before activation of our pneumatic system, we managed to retrieve it. To our surprise, we discovered that the bundle of rope had an anchor and a length of chain attached to one end. On another of many dives, we located and retrieved a 10ft long 4in



Anchor

Taken by: Satone Haratani

diameter PVC pipe that looked as if it had been submerged longer than Titanic. Finally, after being submerged for over 2hrs of trouble-free operation, we conducted a routine inspection of the ROV and found most seals had indeed resisted depths greater than those we would face in competition. Taking the ROV to Lake Cavanaugh was a fun and inspirational learning experience. It was rewarding to effectively operate the ROV we had built in a natural, real environment.



Success at Scavenging

Taken by: Shylan Houghton

## Mission Theme

This year's mission theme is "ROVs in Extreme Environments: Science and Industry in the Arctic". These missions are based on an area about 2,100 km (750mi) from the Arctic Circle, near St. John's Newfoundland and Labrador, Canada.

St. John's is the capital and largest city in Newfoundland and Labrador, Canada. It is the oldest city in North America and embraces many historical and natural wonders. This city is home to Memorial University of Newfoundland's Marine Institute, which houses the world's largest flume tank and the National Research Council's Ocean, Coastal, and River Engineering that has an ice tank and offshore engineering basin. Several oil and gas companies are headquartered in St. John's, while others have offices there. Several needs of the polar science community and offshore oil and gas industry are carried out by remotely operated vehicles. These demands are represented by the following tasks:

## **Mission Tasks**

### *Task One: "Science Under The Ice"*

There are a total of 100 points possible. We must deploy our ROV through a 75 centimeters by 75 centimeters hole in the ice and collect a sample of algae from the underside, collect an urchin from the seafloor, then identify and count various species of sea star. We must deploy a passive acoustic sensor in a designated area, measure the dimensions and calculate the volume of an iceberg, and finally determine the threat level of the drifting iceberg to oil platforms.

### *Task Two: "Subsea Pipeline Inspection & Repair"*

There is a total of 100 points possible. Conduct a Close Visual Inspection (CVI) of corrosion on an oil pipe then turn a valve to stop the flow in an oil pipeline. Examine a dial to determine that the pipeline pressure is zero, subsequently measure the length of the section of corroded pipeline and attach a lift line to the corroded section. Cut and remove the section of corroded pipeline, thereafter installing and secure an adapter flange over both cut ends of the pipeline. Remove the wellhead's protective cover to install a gasket. Lastly, insert a hot stab to simulate injecting corrosion inhibitor into the wellhead.

### *Task Three: "Offshore Oilfield Production & Maintenance"*

There are a total of 100 points possible. We must test the grounding of anodes by measuring voltage across specified points along the leg of an oil platform. We will measure the height and length of a wellhead from the seafloor to determine through calculation the angle at which it emerges. We will use a map to determine the pathway of flow through a pipeline system then turn specific valves on or off to direct flow through a specified path to an end point at water surface. Ultimately we will pump water through the pipeline system to verify flow through the correct pathway to its destination.

## **ROV Design and Fabrication**

### **Frame**

Our frame is designed and constructed to be robust, simple, and easily compatible with our various tools and sensors. It was also designed with the intent of being readily upgradeable with multiple hard points to serve both MATE pool mission tasks and open water exploration. The material used for construction of the frame is 6061-T6 water jetted plate aluminum that has been Tungsten Inert Gas (TIG) welded and has a red and black colored powder coat. Due to time constraints and our leader's desire for us to have first hand experience with fabrication

techniques, we elected to do our own powder-coating of the frame rather than having it anodized as we have with past 13. We stress-tested sample pieces of scrap aluminum with which we practiced and perfected the technique. We found the coating to be a more reliable and durable protection than anodization. This was an interesting skill set to learn and it has proven to be remarkably resistant to various stresses in different environments. The dimensions of our frame are 50.8cm (20in) by 39.37 centimeters (15.5in) by 29.21cm (11.5in) and the aluminum plate is ½ centimeters (0.01in) thick.



Frame  
Taken by: Satone Haratani

## Buoyancy

Our ROV's float is made of 8 lbs per square foot, 1mm (0.039 in) penetration closed foam.



Making the Float  
Taken by: Jay Cocheba

We started out with a piece of foam that was 68.58cm (27in) by 43.18 cm (17 in) by 12.7 cm (5 in). Next, we cut the float down to 68.58cm (27in) by 43.18cm (17in) by 7.62cm (3in). The team logo was designed on Paint. From there, we used a projector to display the image onto our block of foam. We traced the image onto the block with a pencil and used a router to cut the logo into the foam block. We finished the process by overlaying it with a carbon fiber and epoxy resin for protection.

## Ballast

The Ballast assembly for our ROV is comprised of a series of interchangeable plates measuring 5.25cm (2.06in) by 19.05cm (7.5in) and of variable thicknesses. This allows variation of ballast mass to provide slightly positive buoyancy in both freshwater and in saltwater with various payloads. The individual plates have been coated with rust resistant paint to prevent oxidization in marine environments. This assembly is securely mounted below the center of buoyancy of Oceanus II in order to provide a strong righting moment so that our ROV functions as a stiff platform capable of accurate movement under water. Small plates of Invar are used for delicate trimming of the ROV to account for various mission tools and in the event that our center of mass were to change for any reason. ROV Oceanus II generally requires 6.8kgs (15 lb) of ballast for use in fresh water with current mission tooling mounted.

## Thrusters

Last year, we collaborated with team Europa II to construct Sea-Tech Next Generation thrusters. Sealing most reliable because it allowed the flowable silicone to enter the point where the leakage is. We designed our thruster housings on CAD and had them made on a CNC lathe out of 6061-T 6511 aluminum, while team Europa II conducted a series of tests. We have 5 thrusters, each with a 12 volt DC Como drill brushed motor. This year, we shifted two of our thrusters from inboard to outboard to improve the ROV's rotation. We also had complications with leaking and realized that there was severe shaft vibration which was one of the causes. We worked on stopping the shaft from vibrating by attaching bearings to the propeller shafts. In addition to this, we sealed leaks around the wires by using flowable silicone and a vacuum system. We found this system of leakage was and completely seal it. We replaced some seals to guarantee a tight seal. Finally, we measured and cut our propellers down to 78 mm so that they would fit into our shrouds. We then cut out shrouds from aluminum pipe to fit the propellers, turning down the inner diameter to 8.25cm (3.25in) and the thickest point being 2mm. Lastly, we fastened them to the frame using epoxy putty.



Wiring Thrusters  
Taken by: Satone Haratani

## Cameras

We purchased two HD 1000 line cameras fitted with 120 degree lenses. One is mounted to the forward rotating mount. The other faces aft. Last year, we had multiple complications involving leaking camera housings. To remedy this, we rebuilt the housings for our cameras out of PVC couplers and manufactured reducers. To accomplish this, we used 3.5" PVC couplers, 3.5" to 3/4" threaded PVC reducers, schrader valves, primer and medium blue PVC cement. One of the most critical improvements in our design this year was precipitated by the pre-mature gluing of two pieces together that had been intended to permanently



Making Camera Mounts  
Taken by: Jay Cocheba

secure housings to the frame. This seemingly problematic mistake led to an innovative design change. The permanently assembled housings were modified with a lockable sleeve making them removable for inspection, transport, and repair. This has proven very beneficial to us very greatly when working with the camera. Our camera domes were updated to fit this new assembly, and are our only repurposed component in the camera assembly.

## Pneumatics Systems

Our pneumatic system is designed to be the most dependable, straightforward, and durable system possible. It is comprised of many basic elements, our control station comprised of simply two toggle switches, which run and support the claw mechanism and

vertical swing mount as a whole. Our Sea-Tech Legacy Claw was designed by a previous team in Sea-Tech 4-H and is cut from black anodized aluminum. It is actuated through a pneumatic pancake actuator that revolves a series of gears inside the aluminum casing in our claw. Our vertical swing mount is ran using two linear pneumatic actuators that are bolted to rails on both sides of the frame with a series of mounting holes in them, granting us the ability to mount our twin linear actuators at varying intervals and swivel our claw at different angles. At this point, we do not have a mid-point position for either our claw, or vertical swivel; however, we have adjustable bleed down valves which can control the speed at which our systems actuate. Our ROV's entire system is connected using polyurethane lines that run the length of our tether and it is controlled by the Manipulator Operator at the surface with simple on/off valves and an emergency bleed valve. We had a few problems with leakage in the lines early in the season, but they were quickly and efficiently resolved by cutting and replacing the damaged end of the tube.

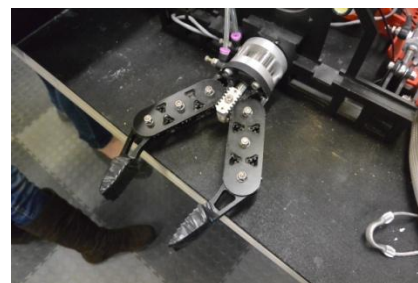

Claw

Taken by: Satone Haratani

## Pneumatics Diagram

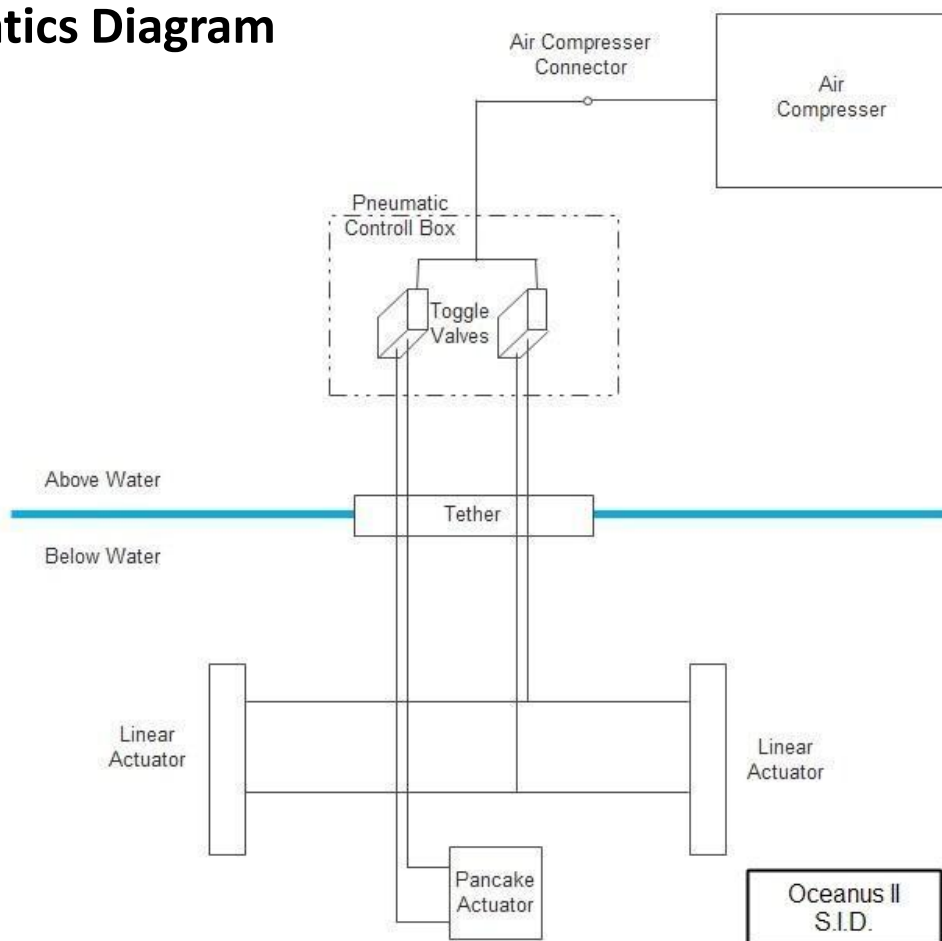

## Electrical Systems

Protected inside of the control box are the components necessary for OCEANUS II to perform safe and successful mission objectives. Our control station is easy to operate, and has the following features:

Control Box: . The control box is comprised of a compact, water resistant Pelican box, designed to withstand concussive blows while keeping all electronics safe and dry.

Micro-Switches: Our control system consists of eight independent micro-switches in groups of four around the trigger end of our two joystick controllers. Due to their simple, robust on-off switching function, no programming was necessary. Each individual switch is rated to sustain 10 amps continuous current which is substantially more than the 2.3 amps drawn by each thruster. The switches are wired to negative in their resting state. When activated, they switch from negative to positive current which is transmitted down our tether to the thruster. This

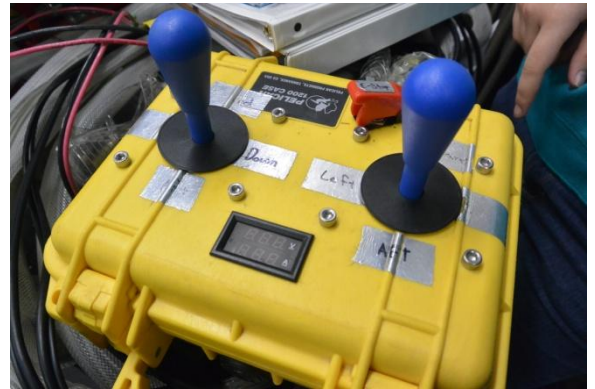

Control Box  
Taken By: Satone Haratani

arrangement permits both switching of thruster on or off as well as reversing polarity. Even with all electrical components running simultaneously, we do not exceed the maximum limit of 25 amps at 12 volts.

Voltage Meter: We have installed a voltage meter on the face of the ROV's control box which allows us to monitor how many volts are being provided to the ROV. This has proven very useful when operating on batteries rather than an AC to DC converter as it helps us determine the state of our battery supply.

In-line 25 amp Fuse: Also located outside of our control box is a single in-line 25 amp fuse for safety in case of an electrical short or circuit overload.

Emergency Stop: When performing a mission, situations may necessitate cutting all electrical power to the ROV immediately. This is accomplished by pressing a large, red power switch that is positioned on the face of the control box for easy access in case of emergency.

Tether Connector: For easy transportation and replacement of the control box, we have a removable tether connector that resides in the box as well. The tether consists of thirteen 18 gage, two conductor wires and pneumatics lines running down to the ROV.



# Wiring Diagram

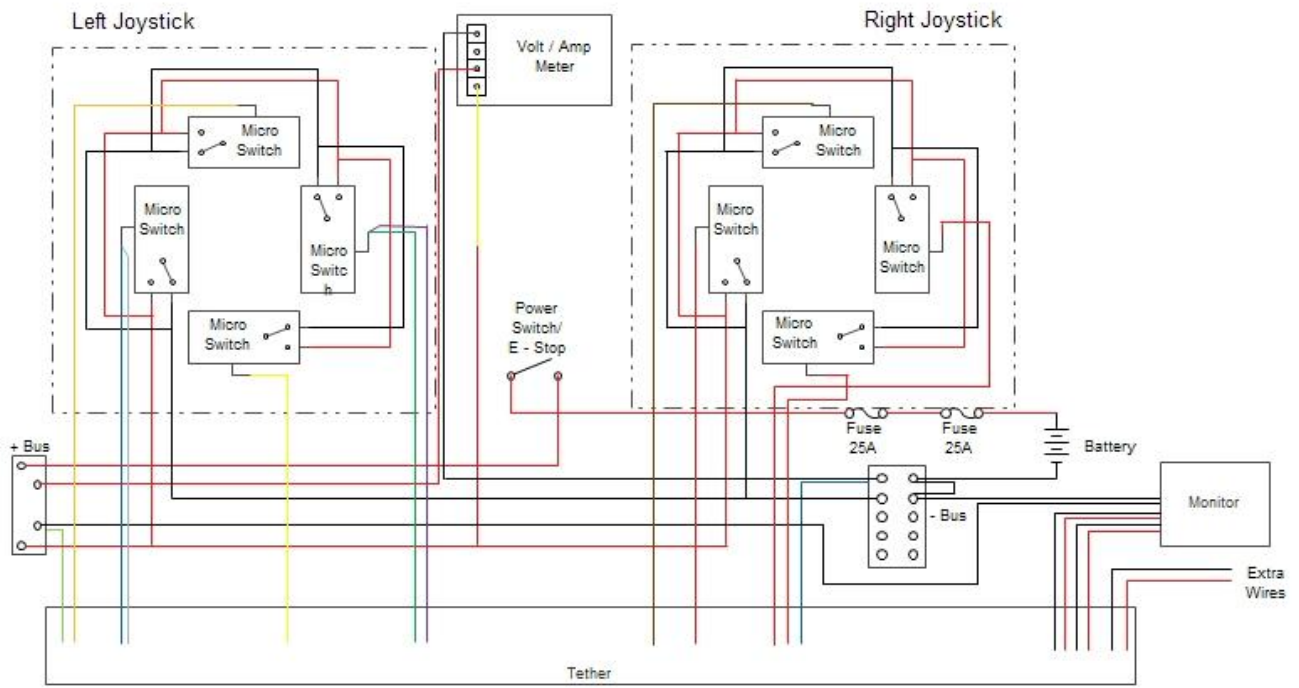

Above Water

Below Water

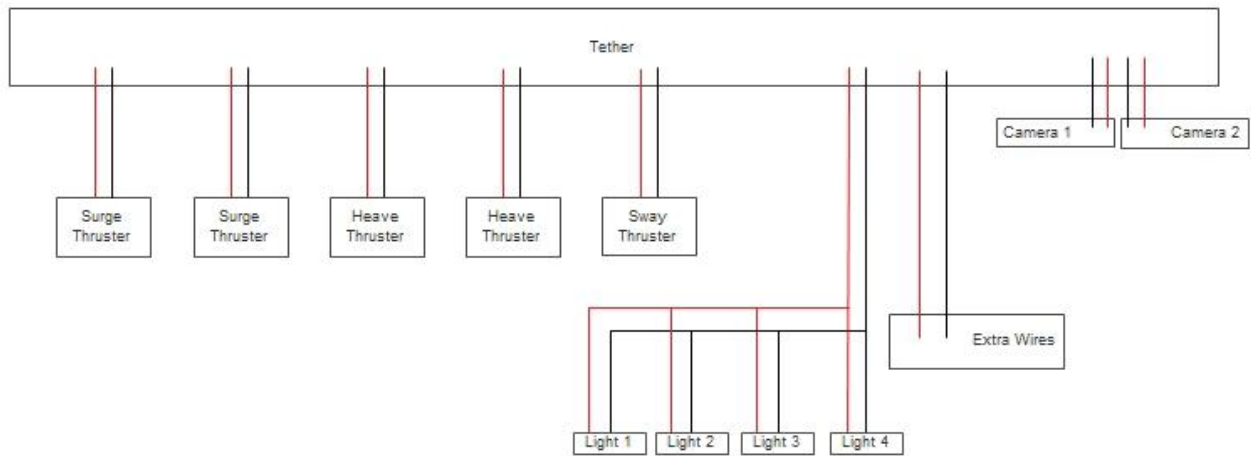

Oceanus II  
S.I.D.

## Mission Tools

Claw: Our Sea-Tech Legacy Claw helps us complete most of our missions and tasks. The claw is operated with our pneumatic system.

Algae Collector: Our Algae Collector is a device that grabs the algae (Ping Pong Balls) from the underside of the ice sheet using two small fish nets in a scissor motion. This device attaches on to our claw with key chain ball locks that is very easy to attach and remove.

Iceberg: We are able to calculate the measurement of the iceberg's total volume using three lines on our screen as visual aids. We start by maneuvering our ROV a certain distance away from the iceberg, then we take a measurement across the screen. The process is completed by comparing the measured size of the PVC pipe with a known dimension and scaling up to full size. The volume of the iceberg is estimated as a cone using the actual radius and height.

Anode Tester: The anode tester is designed as a length of PVC pipe fastened to the side of the ROV directly underneath the float's lip. Four metal prongs are used on the end of this pipe: two for keeping the pipe steady, and another two used for the actual measurement. The voltage of each anode is sent to the surface via two wires, and measured by the Data Analyst.

Pump: A modified bilge pump is used to flow water through the pipeline for Demo 3. This pump utilizes its own tether and ballast, and is positioned by the ROV in front of the pipeline flow coupling during use.

Lift Apparatus: This is a simple device consisting of a carabiner and a tag line. After positioning the carabiner in the ROV claw horizontally, the camera mount is swiveled downward, clipping the carabiner to the desired object. Lastly, the claw is released and the tether tender reels the object to the surface.

## ROV Evolution

The construction of ROV Oceanus began in 2013. We started by modeling the ROV on CAD (Computer Aided Design). We then sent the model of the ROV's frame to Janicki Industries (JI) and they water jetted the frame out of 6061-T6 aluminum plate. We assembled the frame and had it TIG (Tungsten Inert Gas) welded together. After scouring internet stores, we were able to find a motor that would work in the thrusters that we had also modeled on our CAD software. We sent the thruster models to JI where they used a CNC (Computer Numerical Control) mill to cut the thruster housings out of 6061-T651 aluminum. We assembled the thrusters and made our camera housings out of PVC. Next, we made our float from closed cell foam and laminated it. We modified our thrusters and cameras to minimize leaking, re-coated our float with epoxy, and trimmed our ballast. We also changed two of our thrusters from inboard to outboard and made shrouds for the thrusters that were unprotected.

# Assembly

Though we designed our ROV to be simple, it is imperative that the assembly is performed in a step-by-step process:

## Claw Assembly:

To begin the assembly process, we must begin by building the claw. This is assembled by aligning the gears which contact our claw mechanism, within a aluminum housing before bolting our gears in place. We then insert a pancake actuator between the gear casings to run the mechanism.

## Claw to Frontal Assembly:

Next, bolt the claw to the frontal assembly through the four mounting holes located on the frontal frame. Next, attach the two linear pneumatic actuators to the two mounts on either side of the frontal assembly. Connect the pneumatic lines using the bleed down valves and connectors, taking care to run the pneumatic lines for all the actuators throughout the tether to a compressor on the surface.

## Frontal Assembly to Main Frame Assembly:

We will now connect the frontal assembly to the main frame. Start by bolting the swivel hinges located on either side of the frontal assembly to the front of the main frame via two mounting holes for that purpose, and connecting the linear pneumatic actuators, which actuate the swivel, to two mounting rails.

## Thrusters:

The next step is to attach the thrusters and shrouds. Bolt the sway thruster and its shroud together to the roof of the frame. Attach the two surge thrusters to both sides of the ROV, secure two aluminum propeller shrouds to the frame with epoxy putty. Then, bolt the two heave thrusters in their vertical positions forward and aft of the ballast mounting plate. Run the wires of these listed thrusters up the tether to the control box.

## Cameras:

Our camera is inserted into a PVC housing with a plastic dome to protect it from water damage. This is placed directly above the claw assembly in a mount. Then, we attach the back camera in the same fashion to aft section of the frame, running power and video cables from both cameras up the tether to attach to the monitors.

## Floatation and Ballast:

The next step is the buoyancy and ballast of the ROV. Place the float on the top of the bare frame, being careful to slide the holes situated in the float over the bare propellers. Bolt the float to the frame with the holes provided in the four corners of the float. Finally, take the invar and iron plates and bolt them to the central bottom portion of the frame.

This concludes the ROV assembly process.

## Safety Measures

Emergency stop: The emergency stop system is comprised of a toggle switch along with a red switch guard. This is our most important safety feature as it allows us to instantaneously shut down all power in the case of an emergency, or for routine maintenance.

Thrusters: This year the MATE organization made it a requirement to install shrouds on all thrusters. Due to the change in the rules and as a means of increasing overall safety, we fabricated and installed aluminum shrouds on all of our exposed thrusters. The heave thrusters are shrouded within the float design.

Labeling: Warning labels are placed on our thrusters and pneumatic claw. Functional labels are placed on the control boxes. Having labels is helpful in reminding operators what functions they are triggering.

Precautions: We have an established protocol that has been implemented for team safety. For example, we consistently utilize our safety checklist during setup, operation, and shutdown of the ROV. Safety goggles were required at all times while working on and around the ROV. We consistently verify that fingers, hair, and loose clothing are far away from thrusters and pneumatics before power is even applied to the ROV. To prevent accidents, we regularly advise each other of potential risks before and during any activity.

Pneumatic Safety: While operating the pneumatic controls, it is imperative that we do not create a dangerous situation. To achieve this, we have designed our system to be completely leak-proof. Our compressor equipment is pre-tuned and ready to use before we get on the pool deck. Before activating the ROV's pneumatic system, we run through a 'power on' protocol, making sure that none of the lines are obstructed. Pressure is released from the compressor when not in use. All of our connectors are tightly fastened and regularly checked. Our compressor also has an emergency release valve to disperse pressure in case of emergency. Our Manipulator Operator makes certain that system pressure is under 40 psi prior to any activation of equipment.

Other aspects of safety:

Sharp edges have been removed to prevent injury.

Ballast has been reduced as much as possible to reduce weight / physical strain in and out of the pool.

Electrical connections are designed to be connected in only one way, so that there is no chance of short circuit.

All nuts are nylock to prevent backing off during use

Tether uses a strain relief to eliminate the possibility of it becoming disconnected during use.

## Testing and Troubleshooting

For testing this year, the ROV ran through a battery of tests in order to troubleshoot various problems and optimize overall function.

Testing at CEO's Pool: Most of the testing took place in our CEO's pool. To start out, all functions had to be tested to ensure everything was working properly. Once that was established, the ROV was taken out of the pool for inspection. We found that the thrusters and cameras were leaking, pneumatic actuators were leaking air and the weight of our ballast was too great for our ROV to utilize effectively.

Solution: To solve the water leak in the thrusters, a few o-rings were replaced and some vibrating shafts were reinforced with extra bearings. To remedy the actuator leak, the teflon tape on the pneumatic airline fitting needed to be replaced. Another problem we had to deal with was the heavy ballast. Instead of removing the ballast, flotation rings were attached to the tether to keep it afloat, and to lighten the tether drag on the ROV; quickly solving the ballast problem. Finally, we started on resolving the camera problem, we sealed the wire entrance using flowable silicone and a vacuum pump. This enabled us to catch the small leaks located in the rear of the camera mount. The secondary solution to this problem was found in the uneven camera housing o-ring grooves. By smoothing them over and adding one extra groove, we were able to ensure a tight seal.

Testing at the YMCA: OCEANUS was transported to a local YMCA, to begin our second tier testing. During this testing process, the ROV worked on performing various missions in Task 2, namely, the wellhead assembly. During this test, the team found that our camera was placed too far forward to see the claw, thus rendering it highly difficult to maneuver. Furthermore, the camera housing was filling with water. The ROV was quickly removed from the water to undertake a series of tests designed to get to the bottom of the leakage problem.

Solution: To fix the visibility problem, the camera housings were pushed back, making the claw more visible to the camera. To find the camera housing leakage, we coated the housing in a liquid soap, using a bike pump to establish pressure in the camera housing. Bubbles were formed at the leakage site, enabling the team to locate the leak and seal it with flowable silicone.

Testing at Lake Cavanaugh: For the ultimate test, the team took the ROV to Lake Cavanaugh for a much needed practice and some lake bed exploration. We used this opportunity to experiment with the depth and attempting to reach the extreme pressure that the ROV could withstand without leaking. OCEANUS was able to explore the depth of 9 meters (30 feet) for two hours with only minimal leaking.

# Cost

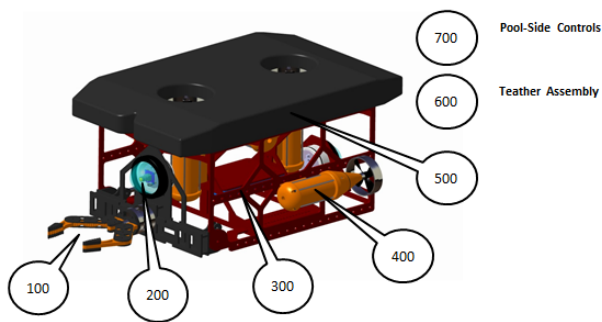

	Purchased	Donated	Repurposed
100 Claw Assembly.....	\$14.32	\$0.00	\$765.77
200 Camera Assembly (FWD and AFT Locations).....	\$33.82	\$199.96	\$149.48
300 Frame and Claw Mount Assemblies.....	\$16.62	\$4.99	\$2,175.02
400 Thruster Assembly.....	\$9.94	\$241.20	\$2,112.33
500 Float Assembly.....	\$0.00	\$0.00	\$204.16
600 Tether Assembly.....	\$63.12	\$29.21	\$598.97
700 Pool-Side Controls.....	\$0.00	\$14.99	\$112.34

ROV Build Value: \$137.82      \$490.35      \$6,118.07

A Shipping, ROV to Newfoundland	\$400.00		
B Airfair, Team Oceanus II	\$4,200.00		
C Meals and Accomodations	\$3,500.00		

Travel Expenses: \$8,100.00      \$0.00      \$0.00

<b>Total ROV Build Value</b>	<b>\$6,746.24</b>
Donated/Repurposed Value	<b>(\$6,608.42)</b>
2015 Build Expenses	<b>\$137.82</b>
2015 Travel Expenses	<b>\$8,100.00</b>
2015 Total Expenses	<b>\$8,237.82</b>
Donation: Skagit County 4H	<b>(\$400.00)</b>
Donation: MATE Regional Award	<b>(\$1,000.00)</b>
Donation: Janicki Industries	<b>(\$500.00)</b>
Fundraising	<b>(\$1,000.00)</b>
<b>2015 NET EXPENSES</b>	<b>\$5,337.82</b>

## Lessons Learned

**Teamwork:** Over this year we've learned that there is no project that can't be completed with hard work and team cooperation. Understanding and working together has taught us that as Team Oceanus, all of us need to cooperate and work hard to get things done. Often, by relying too heavily on one person to get a team's load of work done on their own, it causes stress and frustration to the individual. By constructing the ROV as a team, and by communicating each others ideas, we often come better prepared and less stressed as a whole.

**Communications:** Communication was a big player in this year's ROV competition. By sending out daily email updates, scheduling weekly meetings, answering individual questions, collaborating with our team at the poolside, and most importantly, encouraging one another, we were able to get the job done more efficiently.

**Documentation Skills:** Our Director of Documentation has proven very useful in keeping track of our varying schedules and deadlines, allowing us to review the day's undertakings and look forward to the next day's projects. This has been an invigorating opportunity to learn about the responsibilities involved in documentation.

**Perseverance:** Many times this year OCEANUS was faced with difficult and frustrating problems that often left the members wanting to give up. One of the biggest dilemmas we faced this year was time. Although we were making progress, there were still setbacks that needed to be dealt with. One of the problems that occurred just a few days before the regional event was a leakage that was ruining our front camera. The ROV was transported back to the CEO's house to begin performing 'surgery' to get our camera back online. After lots of time (and paper towels), we managed to dry out all the various components of the camera assembly and reassembled it, getting the ROV back in the water and back on schedule.

## Group Reflection

Team Oceanus has had an amazing year. Most of us have had experience with robotics in the past, but we encountered new challenges this year that we'd never faced before. All of us have learned a great deal from the process of building our ROV, creating the poster and documentation, writing the technical report, preparing presentations, and all of the other activities that we participated in. We jumped into the competition, stretching our limits, improvising and coming up with creative solutions to difficult problems. The team had to learn to work harder than we had ever worked before, under a deadline and with numerous problems that we had to resolve. We had to learn how to keep better lists, organize more time to practice, stay more organized with our parts, among other things. But we got through it, but most importantly each one of us learned to work as a team. We learned to collaborate, even if your ideas get shot down or replaced. And we now have Oceanus to thank for that. We are team Oceanus, a titan amongst gods.

## Individual Reflections

*Spencer Cocheba*

This is my first year as the company's CEO. I learned many lessons from leading our team to success by keeping everyone on task, and making sure our deadlines were met. One of the biggest challenges I faced this year was organization. I have had to learn how to improvise under pressure and make adjustments to goals as deadlines approach. When the announcement was made that this year's MATE international competition would be held in St. John's, Newfoundland, my excitement began to grow. When our team took second place in the regional competition, I was ecstatic. I can hardly wait to visit the facility in Newfoundland and compete with teams from all over the globe.

*Isaiah Houghton*

I've learnt quite a bit over the past few months, how to design, fabricate, troubleshoot, refabricate, the engineering method as a whole; try-try-agains included. Though it wasn't my first year building a machine, it was definitely one where I felt the most involved and had the most fun. Learning to collaborate and work with my teammates was a great experience, one that I would eagerly do again. The build-time and competition I admit was pretty stressful, but the payout of our hard work was completely worth it. I'll definitely be back again, I had an amazing time.

*Satone Haratani*

Although I had very little experience and knowledge about ROVs in the beginning of the season, I learned quickly, and was soon very knowledgeable in most aspects of the ROV. I

look up to my senior teammates for guidance, and have learned much from them and my mentor over the year. It surprised me how much I improved over just one year, learning public speaking skills, and team cooperation, I have been able to use these newfound skills in real life situations such as being able to speak more fluidly in oral presentations for my classes, or helping my fellow students with academic pursuits involving engineering, mathematics, or robotics. Overall, I've had a great experience participating in this club, and would love to come back next year.

#### *Alora Houghton*

Through my involvement with Sea-Tech 4-H and MATE, I have learned many skills. From problem solving to technical writing, it has been an inspirational experience. I've enjoyed the process of fabrication and making improvements on the team's ROV. There was much to learn from the steps involved in improving upon and troubleshooting an underwater scientific tool. The biggest lesson I learned from this year's competition was the value of teamwork; working together to come up with creative solutions to complex problems, and executing them and continuing to learn through trial and error. I have very much enjoyed working with the ROV and interacting with my team members, mentors, and MATE volunteers. One of the biggest things that I felt I could improve upon was efficiency.

#### *Priya Kumar*

This year I have dedicated most of my time to refining and facilitating the team poster and technical report. At the beginning of the year, my goal was to make sure that our missions were completed without complications from the battery. I feel that we have indeed accomplished this goal. Throughout the year, I have gained much understanding from learning about wiring diagrams to becoming the mission commander. The biggest challenge I faced this year was being able to evenly distribute the workload, but I quickly learned to embrace this situation by organizing the different components of the undertakings and allocating them individually to the team members.

#### *Andre Tinnon*

This year I have contributed most of my time to researching ideas regarding new developments for the ROV. In doing this, I have become experienced on the topic of thermal expansion to choose appropriate materials for our ROV. One of the biggest challenges I have faced this year would be leaving halfway through the season due to my family moving, but I tried to make the best of the communication difficulties. I collaborated with the team to continue working and helping out. The most valuable lesson I've learned, while staying focused on my Research and Development position, would be assisting my team without physically being able to attend meetings. At the start of the season, our machine saw quite a number of issues and potential add-on factors. It was exhilarating to see how everyone came together and carried out their jobs and tasks and eventually meet our goals.



## Acknowledgements

We are deeply grateful to our club, our mentors, and our families. We would also like to thank Janicki Industries for the water jetting and welding services that they donated. Special thanks go to Lee McNeil for having conceived of the club and for being such a strong supporter and contributor to our team. We appreciate the businesses and individuals that assisted us with fundraising. Finally, we thank 4H for their financial assistance in shipping our ROV and MATE for giving us this amazing opportunity and for the \$1000 travel stipend. Thanks so much to everyone who helped make this possible!

## References

<http://www.theguardian.com/science/across-the-universe/2015/feb/04/nasa-europa-mission-has-people-excited>

<https://www.youtube.com/watch?v=8m4RXzJLKSk>

<http://www.whoi.edu/oceanus/feature/engineers-honored-for-pioneering-undersea-robot>

<https://www.whoi.edu/page.do?pid=83577&tid=3622&cid=130989>

<http://www.public.navy.mil/spawar/Pacific/Robotics/Pages/CURV.aspx>

[http://www.marinetech.org/files/marine/files/Workforce/KSG\\_ROV%20techFINAL.pdf](http://www.marinetech.org/files/marine/files/Workforce/KSG_ROV%20techFINAL.pdf)

<http://www.rovmarine.it/en/home-eng/14-not-categorized/16-the-history-of-rovs>

<https://www.awesomestories.com/images/user/72f700afd2.jpg>

[http://www.whoi.edu/cms/images/graphics-caymans\\_nereus-dive-P1010032\\_179577.jpeg](http://www.whoi.edu/cms/images/graphics-caymans_nereus-dive-P1010032_179577.jpeg)

<http://martinjclmens.com/the-heikegani-crabs-and-the-problem-with-pareidolia/>

<http://www.mundos-fantasticos.com/en/mythology-and-religion/greek-and-roman/gods-and-heroes/oceanus>

<http://en.wikipedia.org/wiki/Oceanus>