

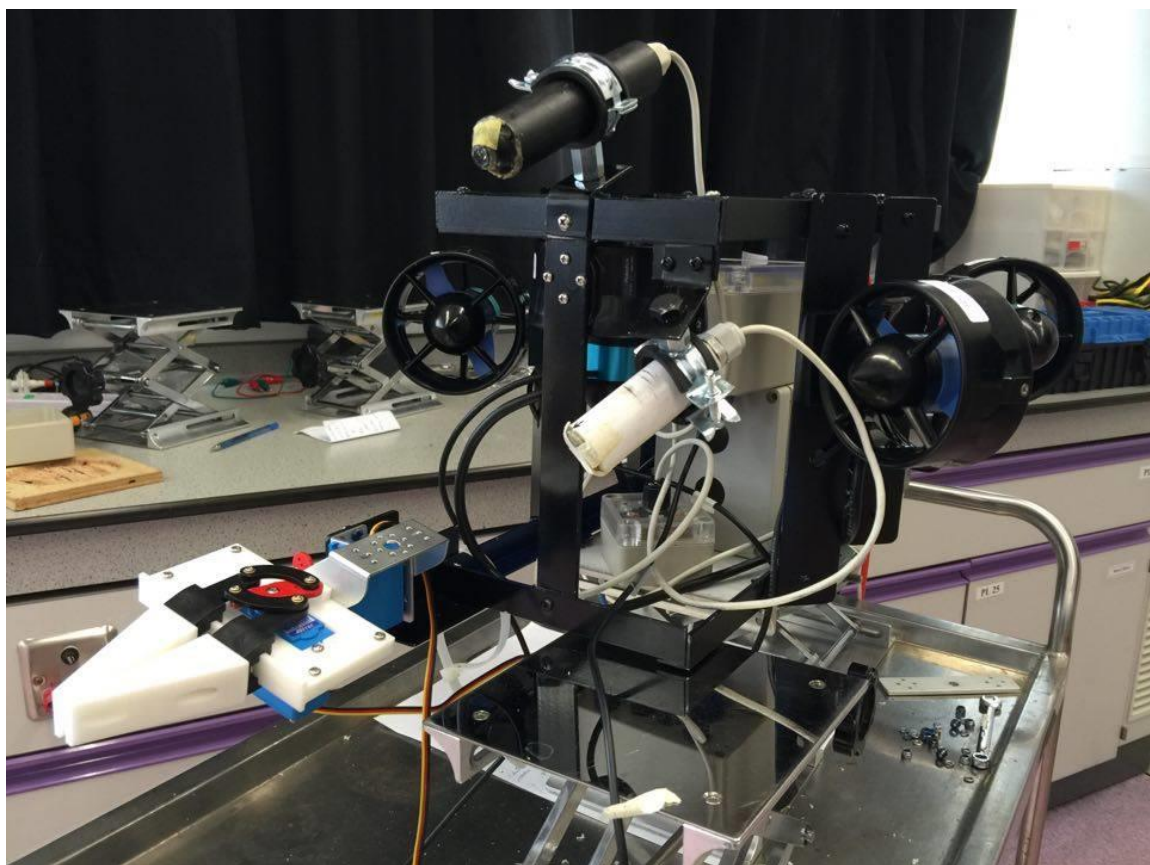

**AquaRobotics Tech II**

**Po Leung Kuk Ngan Po Ling College**  
 **Hong Kong, China**  
**2016 MATE International Competition**  
**Ranger Class**



<b><i>Po Leung Kuk Ngan Po Ling College ROV Team AquaRobotics Tech II</i></b>	
<i>Team instructor</i>	Chan Sung Chun, Bobby
<i>Mentor</i>	Leung Chit Kei, Jacky
<i>CEO, Electrical Engineer</i>	Chau Tsz Lam, Teresa
<i>General Secretary, Pilot</i>	Yip Willis
<i>Chief Financial Secretary</i>	Feng Yi, Tammy
<i>Lead Mechanical Engineer</i>	Lau Suk Ming, Lucas
<i>Lead Electrical Engineer</i>	Wong Yat Chun, Chester

# Contents

Chapter	Section	Topic	Page
1		Abstract	1
2		Company Structure	1
3		Financial Report	2, 3
4		Vehicle System	3, 4
	A	Structural System	4
	B	Power and Control System	6
	C	Navigation System	9
	D	Payload Tools	11
5		Diagram	12
	A	System Integration Diagram	12
	B	Programme Flowchart	13
6		Our Mission	14
	A	Special Arrangement for Tasks	14
	B	Safety	14
	C	Information on Mission Theme	15
7		The Challenges	15
	A	Challenge and Solution	15
	B	Troubleshooting Techniques	16
8		Reflection	18
	A	Future Improvement	18
	B	Reflection from team members	18
9		Acknowledgement	21
10		Reference	21
11		Appendix	22
	A	Safety Checklist	22
	B	Project Management – Work Schedule	23

## **Abstract**

*AquaRobotics Tech II* (A.R.T. II) has been designing and constructing remotely operated vehicle (ROV) since 2014. Our primary objective in our latest project, *Type III MK II*, is to develop a ROV that can make accurate measurement, identification, collection, transportation and installation of various objects.

We consciously apply oceanering technology into our robot design so as to cope with the investigation and research needs conveyed by NASA and Oceanering Space Systems. We aim to incorporate affordable, light weighted and innovative materials into our product. We also focus on energy efficiency and the ease of maintenance of our ROV so that the running cost is to a minimum in a long run. Nevertheless, we have achieved all these without undermining what we value the most – safety, stability and user-friendliness. With all these qualities, our customers can definitely enjoy the pleasant experience when driving our ROV.

The report describes and illustrates the rationale of our design, the research and development process, our troubleshooting techniques and possible rooms for future improvement. Product details of our ROV, acknowledgement, references and appendices are also included.

## **Company Structure**

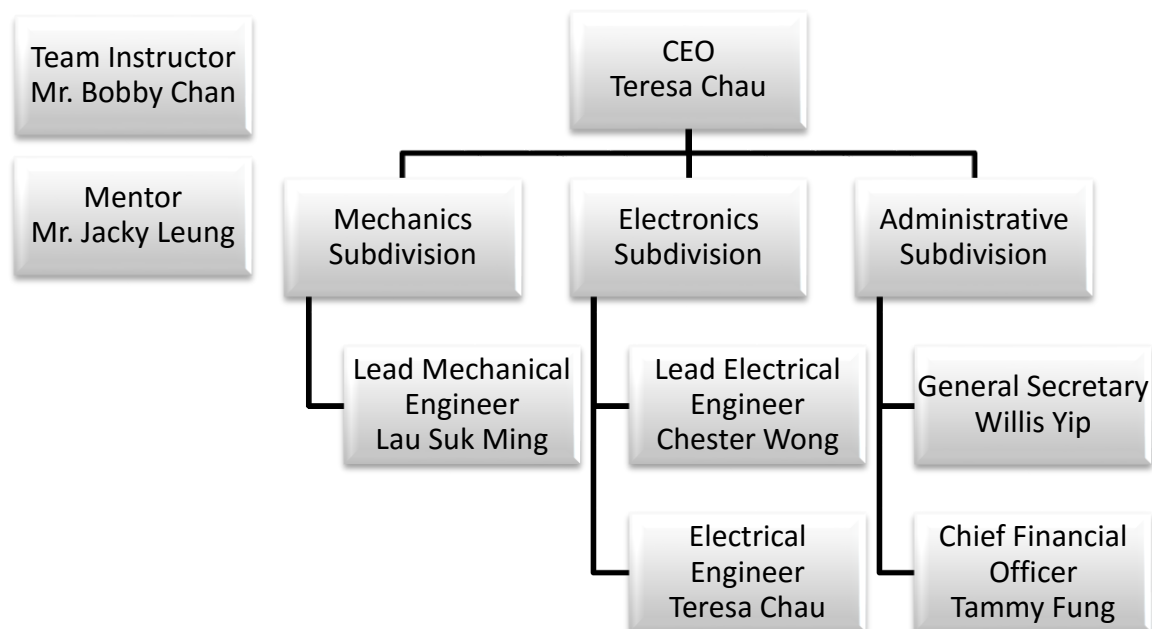

Figure 1 Organization Chart of *AquaRobotics Tech II*

## Financial Report

### 2016 MATE International Competition

Company: *Aqua Robotics Tech II* ROV: *TYPE III MK II*

Category	Item	Quantity	Unit Price (HKD)	Acquisition	Cost (HKD)
Structural System	Aluminium stripes (one metre)	10	20	Purchased	200
	Epoxy	3	30	Purchased	90
	Waterproof Box for Electronic Box	1	95	Purchased	95
	Waterproof Box for Depth sensor	1	35	Purchased	35
Maneuvering System	BlueRobotics T100 Brushless Motor	6	1560	Purchased	9360
Power & Control System	The <i>Initial</i> (power distribution box)	1	500	Purchased	500
	Arduino LCD Module	1	15	Purchased	15
	LCD Voltmeter and Ammeter	1	44	Purchased	44
	micro serial servo controller	1	156	Purchased	156
	Pololu 5V Voltage Regulator S10V4F5	3	40	Purchased	120
	Adjustable Voltage Regulator	1	7	Purchased	7
Navigation System	Wide-angle camera	1	60	Reused	60
	35 degrees analog Camera	1	50	Resued	50
	MS5803-14BA Water Depth Sensor	1	200	Purchased	200
	Active I2C Long Cable Extender Module	1	140	Purchased	140
	HKPilot Mega Mini Gyroscope	1	600	Purchased	600
	minimOSD (for On-Screen Display)	1	130	Purchased	130
Manipulator	Servo HS-5646WP	2	420	Purchased	840
	ABS Filament for 3D print (0.5 kg)	1	200	Purchased	200
<b>Total Cost</b>					<b>HKD12,842 (USD1,650)</b>

For the current project, we got a sponsorship of HKD32,000 for development of *Type III MKII*. In the project kick off meeting, our team decided to search for cost-effective and reliable motors as we encountered critical issue of motor malfunction in our previous project. We also wanted to look into the possibility of using computer and network interface for controlling our robot. We allocated 15% of this initial funding for research & development in which a BlueRobotics T100 with BlueESC was purchased at a cost of HKD1,500 for testing and comparing the energy efficiency and stability with other motors we used in previous projects. Besides, the research fund was invested on developing an integrated control system with a Linux based microcomputer and we expected this new technology could be launched in our next project. For our machine workshop facilities upgrade, we decided to purchase a 3D printer despite of a tight budget as we believed that the introduction of 3D print could help on actualizing our ideas with larger flexibility at lower cost. We ended up with a good 3D printer that fitted our expectation at a cost of HKD12,000. The rest of the funding (around HKD15,000) was used to build *Type III MKII*

After we were qualified for international final, an additional funding of HKD200,000 was given by our school to support us to travel to Houston, Texas, USA for competition in which HKD120,000 was spent on air tickets and HKD60,000 was used for hotel booking.

## **Vehicle System**

The vehicle design of *Type III MK II* emphasizes on its stability, agility and versatility. User-friendliness and high energy efficiency are also our concerns during the procedure of making the ROV. Under the two main criteria of size and weight requested from NASA and OSS, we also include all those functional requirements such as performing scientific research under the ice, repair and maintenance. Our engineering team has made the ROV with the highest maneuverability to complete all the tasks.

We classified the vehicle system into four sections which are *Structural System, Power and Control System, Navigation system and Payload Tools* when designing *Type III MK II*. In order to achieve optimum result, we have been holding project meeting once a week to address the identified and review the overall progress of the project. During sectional meeting, each member could freely present their idea and solve the problems together. When we encounter some complicated problems like the video signal interference during transmission, the whole team have worked together and fixed them within defined time. This has led us into having a vibrant mindset and ended up with many innovative ideas. In the following sections, details of our design will be reported and elaborated.

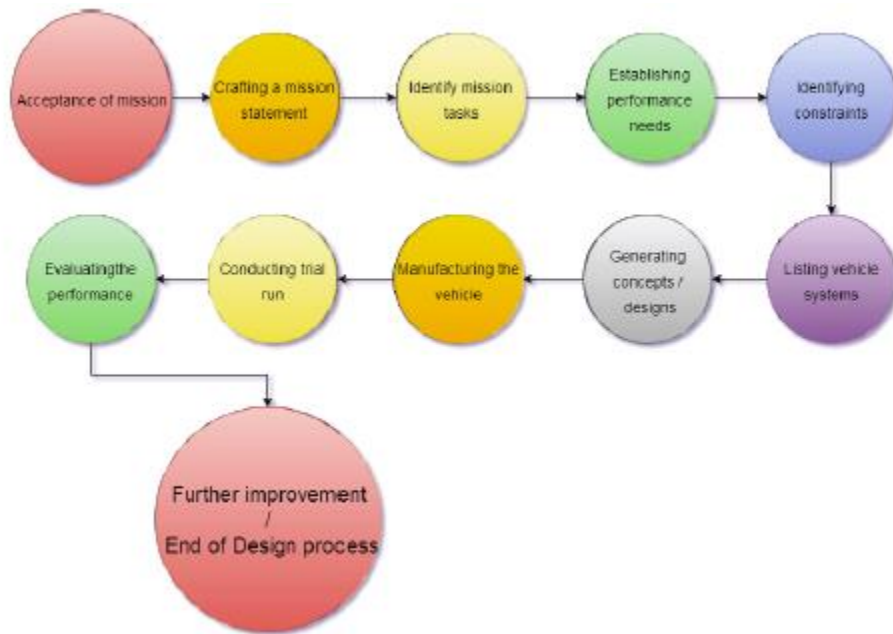

Figure 2 Design flow chart

## A. Structural System

### 1. FRAME

The frame of *Type III MK II* was shaped like a cube. This improved the agility of *our ROV*. Besides, rotation along its axis could also be achieved more easily. The frame was mainly made of aluminium alloy because this material was reasonable, light-weighted, rust-resistant and having high strength.

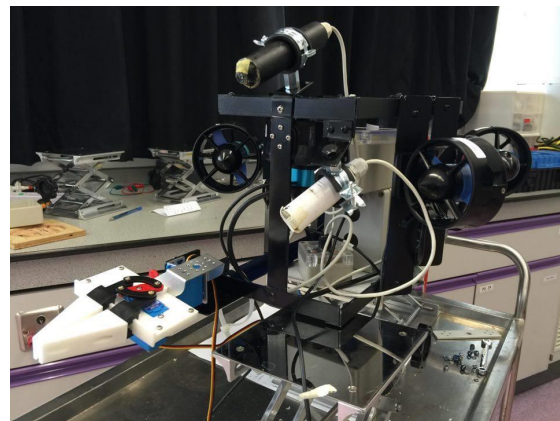
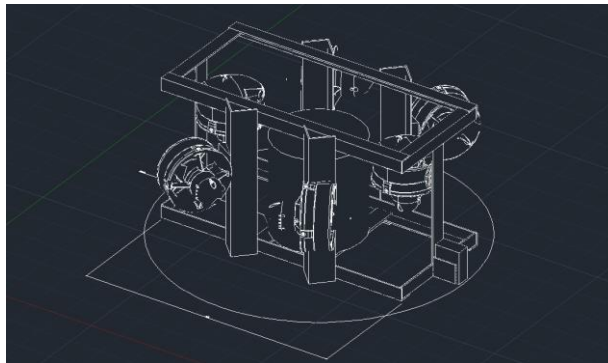

Figure 3 Our ROV – Type III MK II AutoCAD diagram and our final product

Our ROV only weighted 4 kg (10.2 kg with tether) which meant the linear and rotational acceleration of *Type III MK II* could be higher under the same propulsion force according to Newton's Laws of Motion. This could also lower the cost of NASA when launching the robot in space. The flat surface of the aluminium alloy strip enabled easy and precise mounting of motors, cameras and other accessories. In order to lower the water resistance for higher energy efficiency and minimize influences caused by water current and maintain higher stability, an open frame design was adopted.

Apart from minimizing the mass of our ROV, size of *Type III MK II* was only 400 mm x 400 mm x 320 mm. This had been achieved by installing *BlueESC* from *BlueRobotics* in which a waterproof ESC controller for the brushless motors was preinstalled in each motor and this could greatly reduce the size of the electronic box installed in our ROV which is half the size of our previous-generation of ROV. The high strength-to-size of aluminium alloy frame also helped on reducing the size of the frame comparing with a ROV made of plastic pipe.

## **2. 30-DEGREES VECTORES POSITIONED MOTORS**

Originally, motors for propulsion were mounted at an angle of 45 degree horizontally. Practically, this would help to make the turning of the robot much faster. However, the trade-off was that forward and backward movement speed of *Type III Mark II* would be lowered as smaller component of the propulsion force would be used for translational movement. With further discussion and careful inspection of requirement for different tasks, our team believed that translational movement speed was more critical as a long travelling distance was expected.

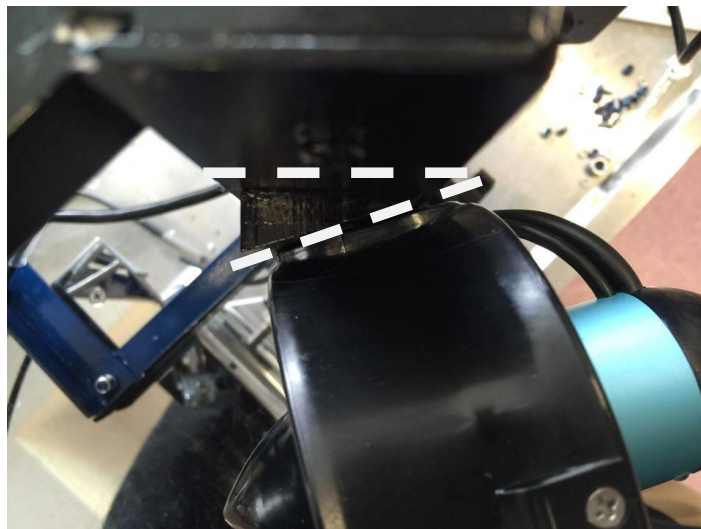

Figure 4 The 30 degrees motor mount

Finally, we had decided to mount the motors at an angle of 30 degrees. This would increase the component of propulsion force in the forward and backward direction by around 120% while turning and shifting ability of *Type III MK II* were preserved. To achieve this mounting angle, our mechanical engineers handcrafted four 15°-75°-90° acrylic triangle columns and had attached to the right-angled aluminium frame.

## **3. CHOICE OF THRUSTER**

T100 thrusters from BlueRobotics were used in *Type III Mark II*. The T100 was basically a brushless electric motor and it included numerous innovative features which made the thrusters stand out from similar thrusters, like Bilge Pump 500GPH, Brushless motors 800Kv. T100 thrusters was purpose-built for usage in the ocean and it was designed specifically for usage on marine robotics.



It could provide over 5 pounds of thrust and it was durable for use in the open sea at great depth. It had high-strength and was UV resistant. Also, this specially designed propeller provided efficient and powerful thrust while active water-cooling kept the motor cool.

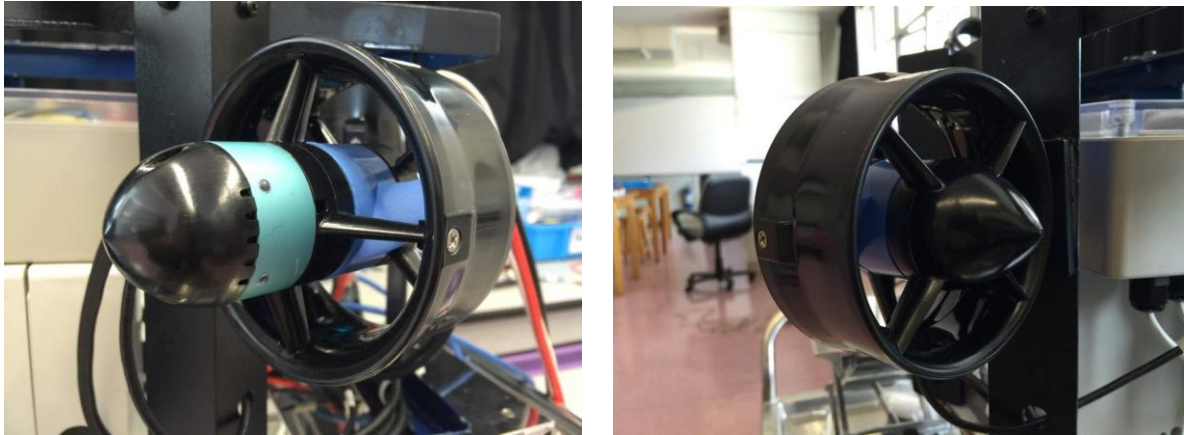

Figure 5 *BlueRobotics T100 with preinstalled BlueESC*

#### **4. MANIPULATOR**

The design of the manipulator was inspired from Gripper of Matrix Robotics System. It used a fixed horizontal axle as a track for moving gripper. In order to lower the cost, reduce the mass and size of the manipulator, our structural engineer had redesigned the manipulator with AutoCAD and had 3D printed it with ABS material.

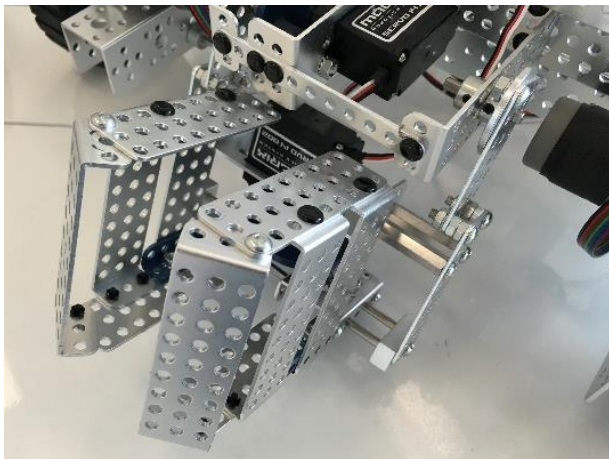

Figure 6 Gripper from Matrix Robotics System

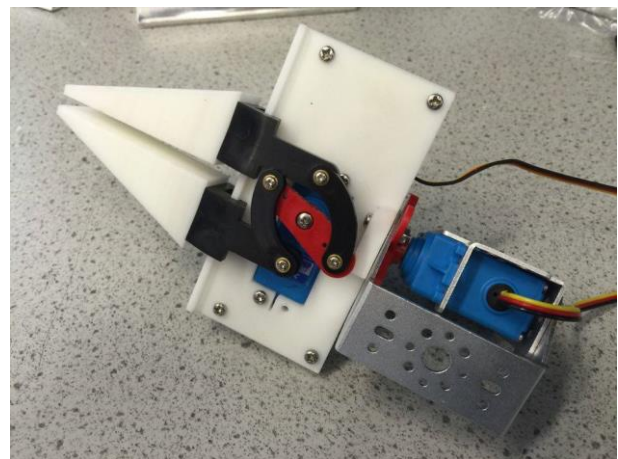

Figure 7 Our Manipulator

### **B. Power and Control System**

#### **1. CONTROL**

The control system for *Type III Mark II* was comprised of a Logitech Extreme™ 3D PRO JOYSTICK controller. It helped to control the movement of the vehicle as well as the manipulator. Many function buttons had been integrated into the controller which allowed pilot to control the ROV with one hand. Communication with Arduino UNO board was done with an Arduino-compatible USB Host



shield. Having an experience of unstable wireless Bluetooth connection between PS3 controller and Arduino at the prototype, a tethered controller joystick was chosen to improve the stability. Our pilots were familiar with such controller such that training on operation of *Type III MK II* could be more effective.



Figure 8 Logitech Extreme™ 3D PRO JOYSTICK controller

## 2. CONTROL PANEL and POWER DISTRIBUTION BOX – “INITIAL”

Our control panel, *INITIAL*, was one of the key elements of our Power and Control System. It acted as a hub of *Type III MK II* in which signal communication, data acquisition and power supply could all be connected in one place.

Customer could customize the information displayed in the LCD monitor according to their needs with different designated programming codes. For our default setting, depth of water measured by depth sensor and temperature measured by temperature sensor were shown on the LCD monitor.

The placement of all components in *INITIAL* was carefully designed and all of them were organized in such a way that quick maintenance and components replacement could be achieved. All the connections were designed to be plug-and-play and setting up the vehicle for operation requires less than on minute.



Figure 9 The *INITIAL*



Figure 10 Arrangement of electronic in *INITIAL*

### 3. TETHER

*Type III Mark II* and *INITIAL* were connected by a 20-meter tether which weighted about 6 kg. It consisted of two 8AWG power cables, two 4 core 20AWG signal cables and one CAT6 LANs cable for operation of the motors, manipulator and sensors.

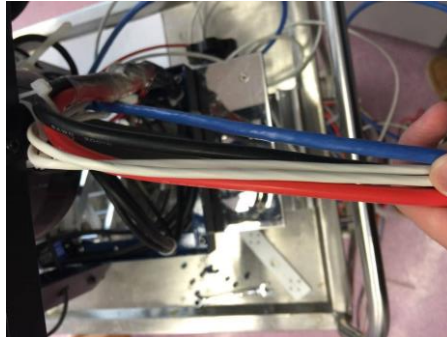

Figure 11 The 20-meter tether

In order to minimize the mass of tether, number of cables and thickness of cables used were our major concerns in designing the ROV. Compromised signaling was chosen for controlling thrusters and servo motors in which micro serial servo controller was used and only one signal cable was used. Comparing with our previous-generation ROV, 8 signal cables were needed for the same purpose. Through many testing, we also decided to use thinnest possible signaling cable while maintaining the signal quality. Floating boards were attached to the tether to achieve neutral buoyancy such that the tether would not hinder the motion of *Type III MK II*.

### 4. ON-BOARD ELECTRONICS BOX

The on-board electronics box was the heart of *Type III MK II*. A *Pololu* Micro Serial Servo Controller, 4 DC-DC converters were installed. Serial signals from Arduino UNO were received by the *Pololu* Micro Serial Servo Controller and then the six T100 brushless thrusters and two servos of manipulator were controlled by the controller through PWM digital signals of different pulse width. The signals from depth sensor and temperature sensor were sent through another 4-core signal cables connected to the *INITIAL*.

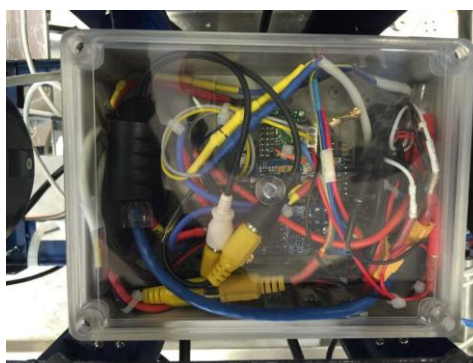
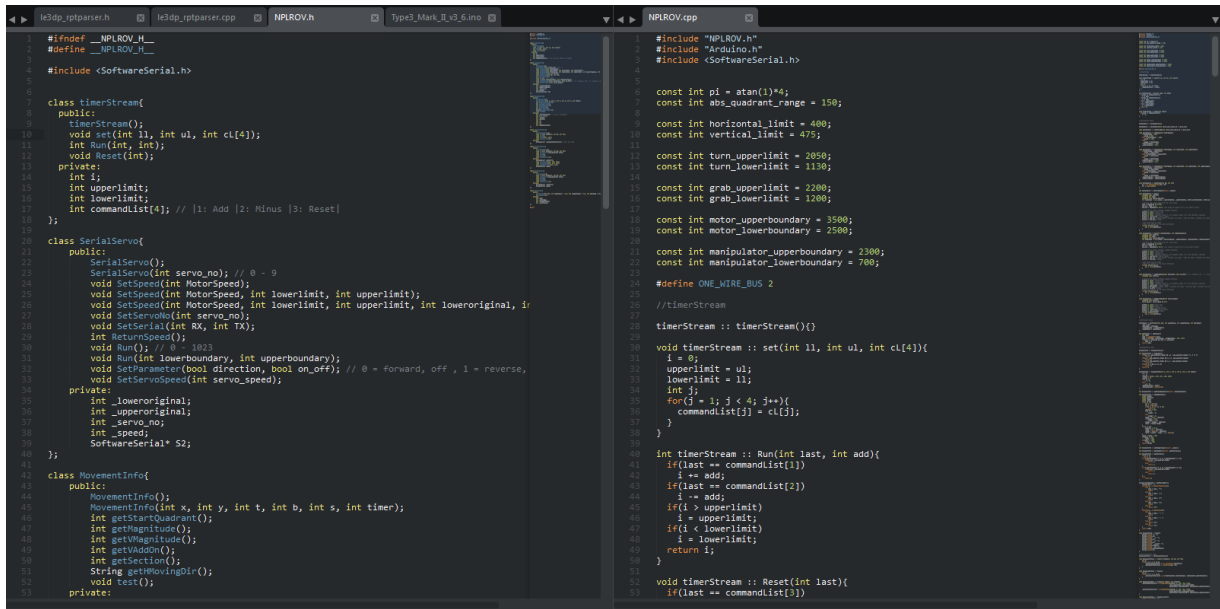

Figure 12 Electronic Box installed on ROV

## 5. SOFTWARE OF OUR ROV

Our company had developed software based on *Pololu* serial servo API for Arduino for controlling brushless motors and servos of manipulator. Object Oriented Programming technique were used to create a sustainable and highly efficient computer programming paradigm. Several tailored made header files were created for easy post-development of our software in our next generation of ROV. This also helped to reduce time lag on operating the ROV so as to develop a highly responsive ROV.



```
#ifndef NPROV_H
#define NPROV_H
#include <SoftwareSerial.h>

class timerStream{
public:
timerStream();
void set(int ll, int ul, int cl[4]);
int Run(int, int);
void Reset(int);
private:
int i;
int upperlimit;
int lowerlimit;
int commandList[4]; // |1: Add |2: Minus |3: Reset|
};

class SerialServo{
public:
SerialServo();
SerialServo(int servo_no); // 0 - 9
void SetSpeed(int MotorSpeed);
void SetSpeed(int MotorSpeed, int lowerlimit, int upperlimit);
void SetSpeed(int MotorSpeed, int lowerlimit, int upperlimit, int loweroriginal, int upperoriginal);
void SetServoNo(int servo_no);
void SetSerial(int RX, int TX);
int ReturnSpeed();
void Run(); // 0 = stop
void Run(int lowerboundary, int upperboundary);
void SetParameter(bool direction, bool on_off); // 0 = forward, off, 1 = reverse,
void SetServoSpeed(int servo_speed);
private:
int _loweroriginal;
int _upperoriginal;
int _servo_no;
int _speed;
SoftwareSerial* S2;
};

class MovementInfo{
public:
MovementInfo();
MovementInfo(int x, int y, int t, int b, int s, int timer);
int getStartQuadrant();
int getMagnitude();
int getMagnitude();
int getVAddOn();
int getSection();
String getMovingDir();
void test();
private:
};
```

Figure 13 Header files developed by our engineer

## C. Navigation System

### 1. CAMERA

Two cameras were installed in *Type III MK II*. The cameras were modified from lower cost door camera and the electrical components had been waterproofed by clear epoxy. The waterproof ability was tested by immersing the cameras into a water depth of 4 meters for 48 hours.



Figure 14 Wide-angle camera for navigation Figure 15 30 degrees Camera for manipulator

One of the cameras was installed on top of *Type III Mark II* for monitoring the environment around

the vehicle and navigation purposes. And the other one was installed along with the manipulator for improving the accuracy of operating the manipulator. We had reused these cameras from our previous-generation of ROV because they are working perfectly and we did not want to increase the budget for something we already had.

## 2. **BALUN - 20 meter RCA Video CAT6 LANs cable adapter**

*Type III MK II* used 2-Channel Composite RCA Video Balun Extender over CAT6 cable of 20-meter long. Balun was added in the video signal transmission as we found that there is signal interference and final images were distorted. With the help of Balun, noise interruption had been minimized. It could also extend the signal transmission distance of CAT6 cable up to 70 meters long which meant our ROV could have a larger potential operable range.

During the development of video signaling, our team realized that optical fibre could be used for lowering the weight of tether and for very long distance transmission. Through several progress meetings, we had finally concluded not to use it as it could be damaged easily and a transmission length of 20 meter was enough for the existing tasks.

## 3. **DIGITAL GYROSCOPE**

A digital gyroscope was installed onto *Type III MK II* to help monitoring the orientation of the vehicle. The digital gyroscope being used was composed of 3-axis gyro, magnetometer and accelerometer. The magnetometer was a chip from Honeywell HMC5883L-TR Digital compass. The compass helped us to find out the heading of objects. The signal values from the digital gyroscope were shown on the video image by using *minim* On-screen Display board.

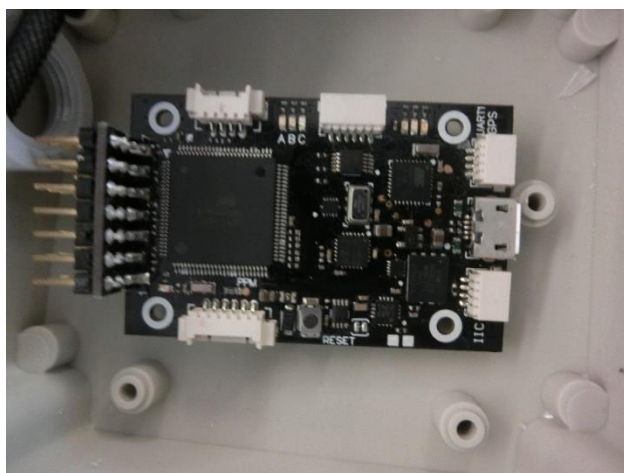

Figure 16 Gyroscope

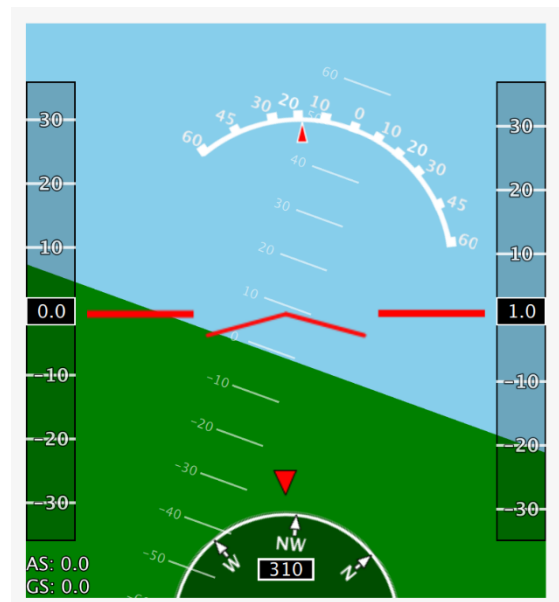

Figure 17 OSD of Gyroscope data

#### **4. DEPTH SENSOR**

The depth sensor installed in *Type III MK II* was a pressure sensor of model MS5803-14BA. The MS5803-14AB is one of the products from *Measurement Specialties*<sup>TM</sup>. It was a high-resolution pressure sensor with both SPI and I2C interface, and it could measure absolute pressure of the fluid around it. The sensor was directly connected to the control panel - INITIAL by the pool side. The signal was processed by Arduino UNO in the INITIAL. With the data from the sensor, operator would be able to find out the current depth of the vehicle as measured from the water surface. Therefore, the keel depth of various objects could also be measured.

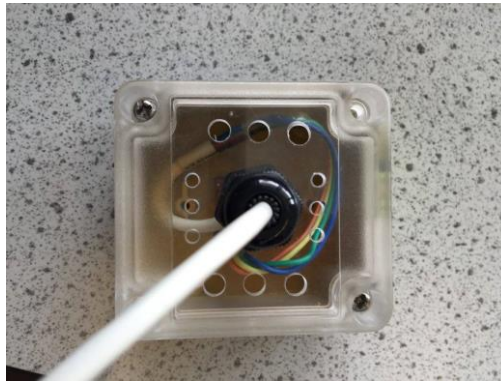

Figure 18 Depth sensor

The depth sensor was calibrated. The calibration work was done in a water tank and performed by our engineer. The depth sensor was attached on a meter rule and our engineer recorded the depth in millimetre and its respective signal value. A calibration curve was obtained and depth of water can be measured based on the curve.

### **D. Payload Tools**

#### **1. CORAL REEF COLLECTOR**

To collect coral reefs, some simple amendments had been made with *Type III MK II*. Safety Walk, which had anti-slipping features, was attached on the inner surface of the manipulator. By doing so, the friction between the manipulator and the coral reef samples was increased and this made firm gripping feasible.

#### **2. OIL SAMPLE COLLECTOR**

To further investigate the oil samples on the sea floor, a V-shaped fork was fitted onto the manipulator of *Type III MK II*. The fork could be used to collect oil samples when it was close to it. The procedure of collecting oil samples was made to be more efficient and with a higher accuracy.



# Diagrams

## A. System Integration Diagram

Any pneumatics or hydraulic systems was not used in our ROV.

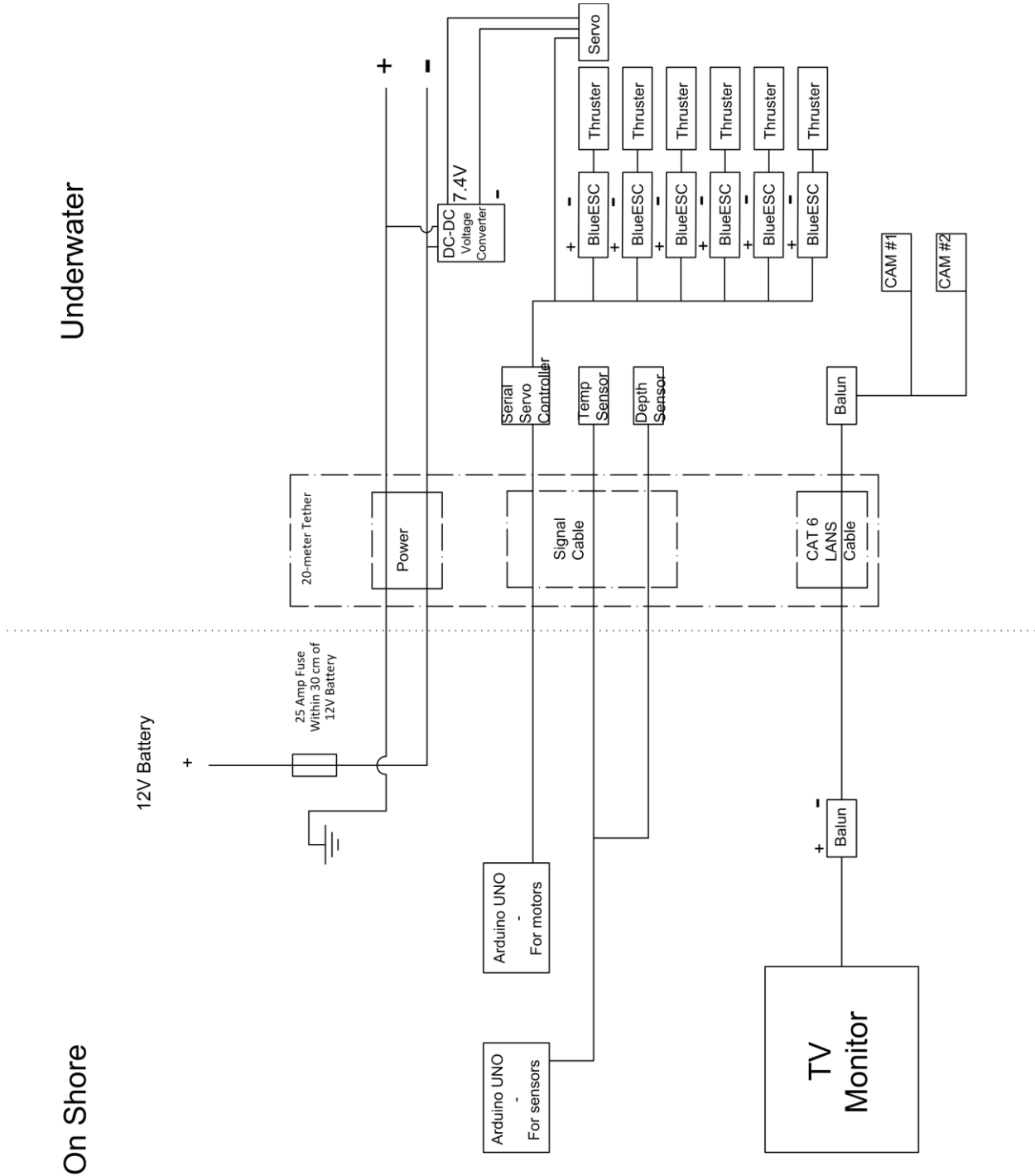

Figure 19 System Integration Diagram



## B. Programme Flowchart

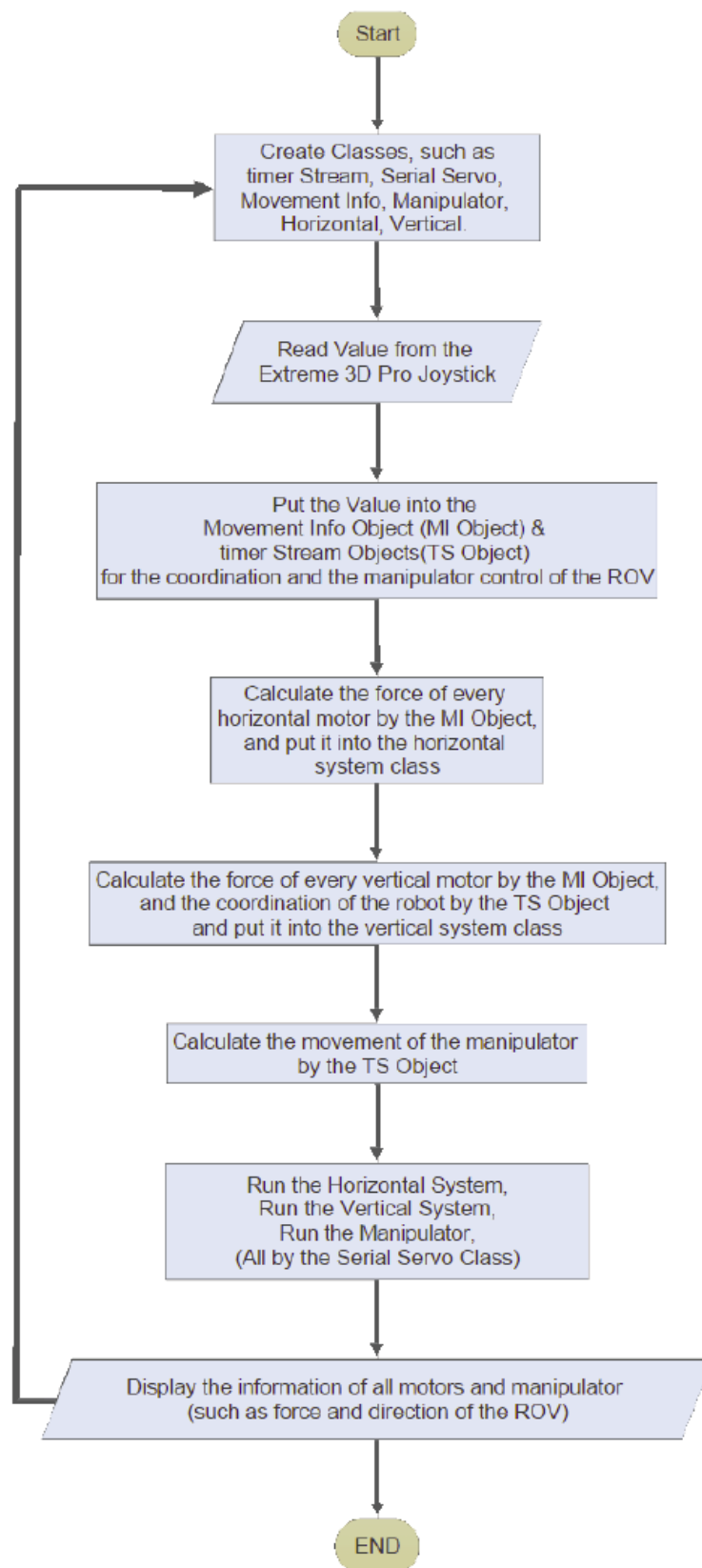

Figure 20 Programme Flowchart

## **Our Mission**

### **A. Special Arrangement for tasks**

There is a list of special arrangements we have done for the tasks:

- For the task of collecting coral reef sample, we had added sponge onto the manipulator. This soft yet firm cushion can greatly reduce the chance that the sample is being damaged by the manipulator.
- For the task of laying cables around obstacles, the camera for manipulator could be easily detached and reinstalled at the bottom of the ROV for monitoring the progress of the cabling.
- For the requirement of weight and size of ROV, the framework, placement of all components on the ROV and arrangement of electronics components were carefully designed with AutoCAD which helped us to minimize the unused space and building material.

### **B. Safety**

#### **1. SAFETY PHILOSOPHY**

Safety is one of the important concerns in our design and development process. The safety philosophy of our company is all possible safety hazards are preventable at all cost.

#### **2. SAFETY PRACTICE – BUILDING PROCESS**

Following safety procedure strictly is everyone's duty. Every member of our company is required to wear protective equipment, for instance: safety glasses, welding mask and gloves for every specific process. Engineers who work with dangerous tools and machineries are required to go through operation manual and training before practice. From manufacturing records, there was one minor incident. Our electrical engineer, Chester Wong, was hurt while testing the programming of running thrusters. Fortunately, it was only a minor injury which was quickly treated with band-aids. Our company has also made our own safety checklist for operators. See appendix A.

#### **3. SAFETY PRACTICE – DURING OPERATION**

In order to protect operators and marine life, *many safety features are included in Type III Mk II*. A 25A main fuse has been installed within 30cm from battery. All motors are shielded with motor guards so that operators and marine life will not hurt from the running blades. All sharp edges are rounded. Potential hazardous parts of the ROV including electronics, propellers and manipulator are labelled with potential hazardous label. Efforts are made on the on-board electronics box which requires extra care to prevent water leaks. Tests have been done to ensure no water leaks into the boxes under a condition of 5 meters water depth in open sea.

On top of the safety features, extra care in handling the vehicle should be taken. Checking the connection of power supply consistently is necessary. The positive (+) and negative (-) pole should never be reversed.

## **C. Information on Mission Theme**

Our company has been nominated to dispatch a robot to outer space and on Earth for a total of 5 operations. Going into the deep sea of Europa and Earth, we have to retrieve samples and data for further analyses on land. We are a team of entrepreneurs and have established a company named *AquaRobotics Tech II*, which devotes time and passion to create professional and competitive robots to be deployed in field operations. We also have to manage the operations of the firm. We have designed and constructed our robots with our entire team, together, completing all tasks assigned by our clients.

## **The Challenges**

### **A. Challenge and Solution**

While working on this project, we have encountered countless challenges that need to be overcome. 3 major problems during the construction of this robot are discussed as follow.

During the construction of this robot, we have indeed encountered a number of challenges. One technical challenge was to make the manipulator operating smoothly. After the first assembly of the manipulator, we had a trial run and found that the manipulator did not operate as planned. The manipulator consisted of complicated wiring, complex structuring and twisty motoring. Our team kept trying different methods to solve this issue, such as adding lubricant or reassembly of the manipulator. In total, we had carried out 57 trials and we succeeded only in the last one. We had identified the immobility problem of the manipulator at the 15th trial, but it took another 40 trials to make it work. It isn't the problem of lacking robotics knowledge; but we'd like to make the manipulator obtain sustainability and durability. Disassembling of the manipulator is time-consuming. It's also inefficient and ineffective for a robotics company to receive faulty engine parts and do maintenance on our products on a regular basis. Hence, we have an ideology to try curating or creating every single part of every internal compartment to be "picture-perfect" state. We had carried out same processes and placed the same ideology on every compartment as well. We had found that the problem was caused by the poor alignment of the pinion and worn gear which stopped the turning of the pinion. The problem was solved by finding the central axis of the gears and carefully aligned them. Perfect alignment was not easy for our team to solve. It requires space for the most suitable alignment of the wires and to obtain sustainability and durability which was the goal and aim of our team.

The second challenge is ineffective job allocation. Our team consists of experienced members and less experienced ones. To construct a high-end robot with superior quality, it is essential to allocate positions according to talents of different members as it becomes the backbone for the development of our ROVs. Again, some of our teammates are new to the competition. Therefore, it is quite difficult for our team to identify talents of our team members and to allocate right positions and tasks to

everyone. When constructing the robot at first phase, members could choose their duties freely. As everyone is passionate to robotic devices, we would like to try out everything new. Hence, our team members were involved in all tasks when constructing the robot. After a small part of a task was completed we would switch our job so that no one got bored in repeating the same task. Yet, we did not realize the precautions which one should take during the construction at different stages. When one member committed a wrong production stage, the mistake carries on. We had to start all over again with the mistaken parts. We revealed the assignment role of everyone and we realized that we had been wrong from the beginning. The process could be disappointing, but we did not give up. We sat down and further evaluated the process of each member when constructing the robot and did analyses on this first trial. Through this analysis, we have come to find out the personal qualities and strengths of different members in our team. In the second try of construction, we have smartly assigned each person a role accordingly and focused on one single aspect which was with comprehensive understanding of our products. Finally, we have completed a “picture perfect” state robot, the *TYPE III Mark II*. We are thrilled and glad that we had completed our dream robot.

Another challenge was to strike a balance between safety and innovation. We understand that safety always comes first. At the first sight, we did sometimes find that safety hindered us from being innovative in some design and production. Therefore, we sought help from our mentors to discuss if there could be an alternative to the same goal without undermining safety. After the discussion, we did came up with new approaches to the same issue, which made striking the balance viable.

Challenges are the stepping stone to make us more skillful and professional in robotics. We understand that constructing a robot is not simple. Not only does it require steely determination to complete a process stage, it also needs our dedication, passion, commitment and perseverance.

## **B. Troubleshooting Techniques**

No one knows if our design is faulty or flawless until we run various tests on each component mentioned above. Besides, as the level of complexity of our robot is high, integration of all components can also be troublesome. Therefore, various components tests and whole vehicle trial runs were completed many times for spotting any possible problems as well as improvement which could eventually bring out the best of our work. In the final month of preparation, regular water tests were performed in the swimming pool of our school. In general, a troubleshooting flow chart was established.

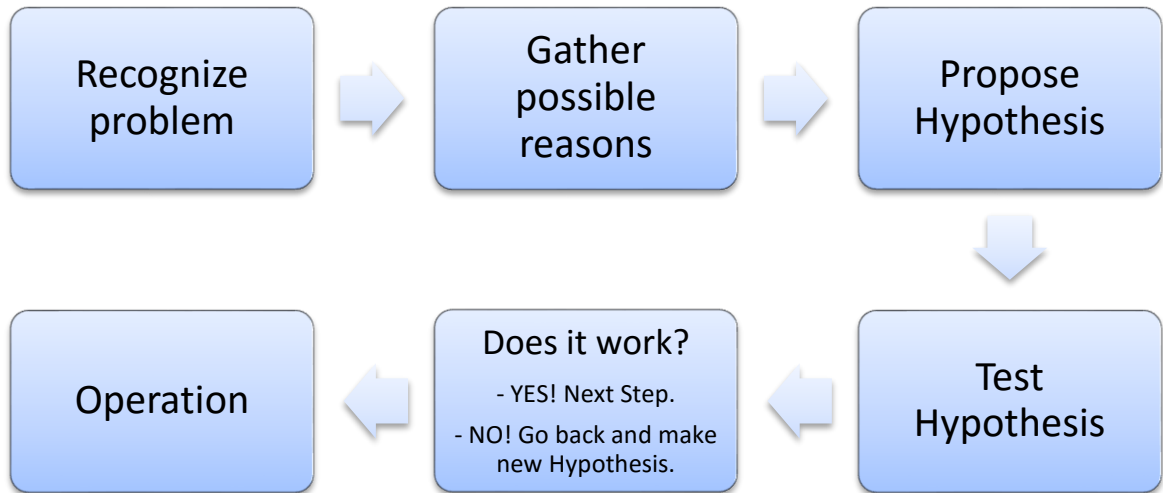

Figure 21 Troubleshooting Flowchart

In the coming part, a case in which we had applied our established troubleshooting procedures will be briefly described. Initially, video with poor quality was displayed on the monitor. We speculated that it might be caused by poor soldering in wire connections. However, the same problem persisted after we had re-soldered all connections by our most experienced electronic engineer. In one of the progress meetings, one of our teammate suggested using 2-Channel Composite RCA Video Balun Extender. Finally, the image was clean and clear after the Balun was installed. Therefore, we concluded that using Balun is a cost effective way to reduce signal noise in 20 meter signal transmission through CAT6 cable.

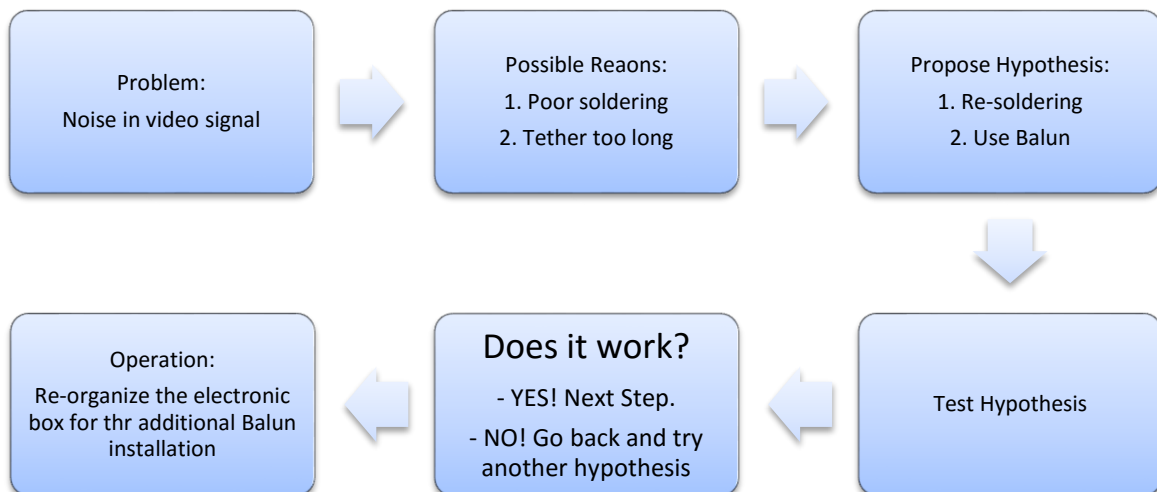

Figure 22 An example of our troubleshooting procedures

# **Reflection**

## **A. Future Improvement**

### **1. PRINTED CIRCUIT BOARD (PCB)**

In the future we will try to use Printed Circuit Board (PCB) etching method to minimize the wires used for connection among Arduino processors, motor driver boards, ESC controller as well as various digital sensors. PCB can also be applied for low voltage power supply and power distribution system. This can help on better integration of electronic components and therefore reducing the size of the on-board electronic box. This can also help on resolving the loosing connections problem.

### **2. NEW SIGNAL TRANSMISSION FORMAT**

In order to reduce the thickness and mass of the tether, we would like to explore the possibilities of using data encryption and decryption in signal transmission so that less signal cables are needed.

### **3. INCREASE THE DEGREE OF FREEDOM (DOF) OF MANIPULATOR**

A third servo will be added to introduce up-down motion of the manipulator which can help to reduce the effort spent on slight adjustment on the vertical position of the ROV.

### **4. ADDING SERVO THAT ALLOWS CAMERA FOR NAVIGATION TO PAN ITS DIRECTION**

Two servos will be installed along with the navigation camera such that pilots can have a wider field of view when observing the environment without moving the ROV.

### **5. PREPARATIO OF SECOND TIER TEAM MEMBERS**

Apart from technical issues, we would also like to develop teaching curriculum and aids for the betterment of the ROV knowledge and experience to new company members. This can definitely help the growth and long term development of our company.

## **B. Reflection from team members**

### **1. TERESA CHAU (CEO)**

Throughout the course of developing *Type III MK II*, I acquired knowledge ranging from building a robot to leading a team. Those experiences are valuable learnt skills that are applicable in my life. As the CEO of *Aqua Robotics Tech II*, I am responsible for dividing jobs for my teammates and to check their progress by holding meetings frequently. Being a team leader requires good interpersonal skills and excellent leadership skills. At the same time, I need to have the basics for each stage and part. I enjoy working in *Aqua Robotics Tech II*. All of us cooperate very well and have tried our very best in the competition of the project.

### **2. LUCAS LAU (MECHANICAL ENGINEER)**

This has been the second year for me joining the ROV competition. In the first year, I have learnt



about the basic mechanics of a robot. To further improve myself, I have completed a lot of researches on the old robot, ranging from the basic framework of the robot to the operation of different accessories. As a mechanical engineer, I have learnt how to use AutoCAD to design a shape that can have the highest efficiency. Besides, I found it intriguing and useful to apply 3D printing to our device, to print a manipulator. I hope to participate in the ROV competition in future again.

### **3. CHESTER WONG (ELECTRICAL ENGINEER)**

After participating in the ROV competition for consecutively two years, I am proud to say that I have learnt more skills in programming. With the experience learnt from last year's competition, I have developed a deeper understanding about the fundamental principles of programming; including input, process and output. Furthermore, I have built a library using Computer language (Object oriented programming style). Wiring is a challenge for me. Although I have studied Core Physics as my elective, the chapter on circuit is not sufficient in equipping me with the knowledge needed to build this system. Not only do I have to understand the different function of different wires, I also need to understand the functions of different wiring devices such as fuses, capacitors, resistors, etc. I have spent a lot of time in learning them. What is the most important is that I have learnt more about the problem solving skills and they will be useful for my entire life.

### **4. WILLIS YIP (GENERAL SECRETARY)**

It has been a pleasant and fun experience to explore the magical and scientific world of robotics and engineering. I'm glad that I could meet up with a superb team to cooperate in this competition. I thank my mentors and teammates for introducing me and bringing me into this wonderful world of robotics. I am a novice student in the world of robotics and there are many areas in the robotics world I have yet to explore. We are able to cooperate with each other. However, I am new to the robotic world and my teammates; thus I am incapable of understanding the strengths and weaknesses of my teammates. In future events, I will be able to bond with my teammates and understand more about their potential and talent. Lastly, I have faced lots of failure in trial runs and overcome lots of barriers which have blocked my way towards success. I was very disappointed and depressed when I'm stuck. It could be very confusing to be stuck in billions of robotics knowledge. But I have realized I can learn from my mistakes. I have learnt that what does not kill me makes me stronger. I promise to spend more time in future to study robotics. I truly enjoy this experience and beg for more to come.

### **5. TAMMY FUNG (CFO)**

This is my first time being a Chief Financial Secretary. Plenty of design ideas have been suggested by my teammates after progress meetings. However, some robotic parts could cost a lot of money. Thus, I have searched many websites online to find an alternative or a solution to solve their problems. Also, as a mechanical engineer, I have learnt how to build a ROV with the help of my teammates. All these time I have spent with my teammates are enjoyable and treasurable moments for me.

## **6. AS A TEAM ...**

Working together is the only way to complete this project. As discussed before, a ROV consists of many components; namely mechanical, electrical, electronics and programming. One person can go fast, but together we can go further. Division of labor could help to pin down knowledge requirement of each teammate so that we could use everyone's strength effectively. However, things could never be put together if the development was done independently. So, we have been holding regular progress meeting to help everyone understand what has been happening and how everything could be adjusted to fit the needs of this project. We have also created a schedule of project and referred to it regularly to monitor our progress.

## Acknowledgement

To begin with, we would like to thank our regional contest coordinators The Institution of Engineering and Technology and MATE Hong Kong for organizing the Hong Kong regional contest. We would also like to thank MATE (especially Jill Zande and Timmie Sinclair) for holding the International Final Contest and bringing us through all those complicated security issues. Besides, we thank all judges and helpers for your hard work in providing this treasurable opportunity for us to exploring in the world of oceaneering. We would also like to sincerely thank our school principal, Dr. Hong Lo Chi Chun for providing us with financial support and training facilities. Moreover, our mentor, Mr. Bobby Chan, and Mr. Jacky Leung have shared a lot of past experiences and encouragement during the design and construction process. We would like to thank them for inspiring us and bring us into this wonderful world of robotics. We would also like to say thank you to Ms. Wong, our Physics Lab technician, for teaching us how to use tools, and machinery. She has been accompanying us until late evenings during our work. We applaud everyone who helped, encouraged us and made effort in the project. Last but not least, we would like to thank all the local sponsors who helped to make the event successful.

### Organizer



### Sponsors



### Reference

- [1] BOHM, HARRY, JENSEN, VICKIE and MOORE, STEVEN W., ZOLO, "Underwater Robotics – Science, Design & Fabrication", Marine Technology Education (MATE) Center
- [2] MARC VILA MANI, "A quick overview on rotatory brush and brushless DC motors", Motion Control Department

## Appendix

### A. Safety Checklist

Procedure	Operation	Person-in-charge	Checked? (T/F)
1.	Check main fuse and the 3 other fuses which are used for the 12V output	Pilots	
2.	Clear the tether	Poolside operator	
3.	Clear all the things surrounding the ROV	Poolside operator	
4.	The box (attached to the robot) must be closed firmly	Poolside operator	
5.	Connect all wires to the quick-fit electronic box	Pilots	
6.	Check on the computer to see whether the output value for the motor driver is 0	Electronics engineer	
7.	Start the ROV	Pilots	
1.	Turn off the ROV	Pilots	
2.	Disconnect the quick-fit electronic box with the power supply	Pilots	
3.	Place the ROV on the pool side	Poolside operator/ Electronics engineer	
4.	Disconnect other wires	Pilots	
5.	Leave	N/A	

## B. Project Management – Work Schedule

Our team had developed and maintained a schedule to aid in building the vehicle. k to the schedule to ensure the best collaboration between divisions and the team could do more water testing.

	Nov-15	Dec-15	Jan-16	Feb-16	Mar-16	Apr-16
1 Paper Design Draft of Robot						
2 Design in AutoCAD of Robot						
3 Control system design						
4 On shore electronic box design						
5 Underwater electronic box design						
6 Understanding tasks and requirements						
7 Correction of Design of Robot						
8 Design of manipulator						
9 Research for task based equipments						
10 Gathering of all required parts and materials						
11 Building the structure of robot						
12 Production of manipulator						
13 Incorporation of control joystick into the control system						
14 Connection of wires for the on shore electronic box						
15 Connection of wires for the under water electronic box						
16 Attachment of manipulator						
17 Attachment of cameras						
18 Testing of cameras						
19 Testing of sensors						
20 Attachment of sensors						
21 On ground testing of robot						
22 Labeling of potential hazards						
23 Adjustment of robots						
24 Safety Checks						
25 Accomplishment of Robot						
26 Water testing						
27 Adjustment based on testing results						
28 Final water testing						
29 Poster draft						
30 Technical report draft						
31 Finalized poster						
32 Finalized technical report						